



Owner's Manual



APPROACH
Tech BodysHELL **ADVANCE**

APPROACH
Autograph
All-Tech BodysHELL

One of the leading suppliers to the caravan & leisure industry



Sofas

Armchairs

Curtains

Voiles

Blinds

Upholstered Seating

Mattresses

Refurbishments

Tables & Chairs



BELFIELD
FURNISHINGS

www.belfieldfurnishings.com



OWNER'S DETAILS

MODEL:

VEHICLE REGISTRATION NUMBER (NUMBER PLATE):

VEHICLE IDENTIFICATION NUMBER (BOTTOM OF WINDSCREEN):

VEHICLE PRODUCTION NUMBER (INSIDE GLOVE BOX):

OWNER'S NAME:

ADDRESS:

.....

.....

TEL NO:

HABITATION KEY NUMBER:

RETAILER'S NAME:

RETAILER'S ADDRESS:

.....

.....

TEL NO:

MTPLM: REAR AXLE LIMIT:

FRONT AXLE LIMIT: GTW (GROSS TRAIN WEIGHT):



Please note fitting of electrical equipment or accessories which are not recommended by PEUGEOT or BAILEY OF BRISTOL may result in a failure of your vehicle's electronic system. Please note this specific warning. It is advisable to contact a BAILEY OF BRISTOL retailer to be shown their recommended equipment and accessories. A BAILEY OF BRISTOL retailer will be able to fit accessories for you.

Your vehicle is fitted with only some of the equipment described in this document, depending on the range level, version and specification.

For any work on the habitation compartment of your vehicle, use a BAILEY OF BRISTOL or NCC approved workshop.

The Approach Autograph and Compact ranges of motorhomes have been designed to satisfy the motorhome customer in terms of practicality, comfort, safety and aesthetics. In order to get the most out of your vehicle we suggest that you take this handbook with you on your first trips. The handbook presents the operation of the equipment available on board in detail. Please be aware that this handbook is for the habitation compartment of your motorhome. There is a supporting document supplied by Peugeot for the vehicle instructions and information. You will find that document inside your vehicle documentation pack.

Bailey of Bristol thank you for your confidence and wish you very happy touring!

1. INTRODUCTION	7-10	3. GENERAL ADVICE	16-25	4. SAFETY EQUIPMENT	27-29
Driving Licences	8	DRIVING LICENCE	16	AMC Chassis	27
CONFORMITY	9	ADVICE ON TOWING	16	Smoke Alarm	27
SECURITY	9	MOTORHOME CODE	17	Carbon Monoxide Alarm	28
Theft:	9	Arrivals	17		
Additional Security	9	Vehicle Movement	17		
Important Terminology	10	Selecting a site	17		
		Use of Site:	17		
		Noise	17		
		Dogs and Pets	18		
2. BAILEY WARRANTY	11-15	Fire Precautions	18	5. CONNECTION OF SERVICES	30-35
		Awnings and tents	18	WATER SYSTEM	30
Motorhome Warranty Cover	11	Departure:	18	Fresh and Waste water Tanks	30
Warranty Extension	11	Wild Camping	18	Frost Protection.	30
Customer Support	12	Parking	18	Fresh Water Pump	30
Terms and Conditions	12	Driving	18	Operating Instructions	30
Warranty Registrations	14	Handbook	18	Routine Maintenance	32
		Environment	18	Draining and winterising	32
				Adjusting your pressure Switch	33
		The Country Code	19		
		The Coastal Code	19	GAS SYSTEM	35
		Your Motorhome (Weights Explained)	19	General information	35
		Roof Loading	20	Types of Gas	35
		Before Moving Off	21	Regulator	35
		Speed limits (UK)	21	The Autograph Range	36
		Seat Belt Legislation	22	Gas Hoses	36
		Child seats	22	Precautions	36
		Airbag	22	Operating Instructions	37
		Releasing the seat belt:	23	Changing the LPG Cylinder	37
		Jacking:	23	Hose Change	37
		Removing the spare wheel	23	Gas Leaks	37
		Changing front wheels	23	Ventilation	38
		Changing rear wheels	23		
		Fire Extinguishers	24	ELECTRIC SYSTEM	39
		Ventilation and Condensation	24	230 VOLT	39
				On Arrival at Motorhome Site	39
				On leaving Motorhome site	39
				Generators	39

Overseas connections	39
Motorhome Service Systems	39
Mains unit	40
12 VOLT	40
Auxiliary Battery storage/mains inlet	40
Banner Leisure Battery	41
6. FITTED EQUIPMENT	43-88
THE AUTOGRAPH CONTROL PANEL	43
THE ADVANCE CONTROL PANEL	46
THE ALDE HEATING SYSTEM	51
Operating Instructions	51
Description of functions	51
Electric Heating	51
Domestic Hot Water	51
Draining Fresh Water	52
Heat Transfer Fluid	53
Central Heating	54
Circulation Pump	54
Bleeding Air	55
Air Lock	56
230v Electric	56
LPG	56
Flue	56
Maintenance	56
Winter	57
Troubleshooting	57
Warranty	58
THE ALDE CONTROL PANEL	58
Starting the system	58
Standby Screen	59
Main Menu	59
Desired Room temperature	60
Domestic Hot Water	60
Electric Heating	60

Gas Heating	60
Shutting Down the System	60
Setup	60
Restore Factory Settings	61
Setup Expansion Tank Pump	61
Setup Antimicrobial Function	61
Setup Standby Screen for bedtime	61
Maintenance	61
Troubleshooting	61
CAPRICE COOKER	63
Operation	63
Using the Hotplate Gas Burners	63
Using the Electric Hotplate	64
Using the Grill	64
Using the Oven	65
Oven Temperature Control	65
Cooking Guidelines	65
Leaks	66
Maintenance	66
Service	66
COUNTRY LEISURE APPLIANCES	67
The Linear Hob	67
The Midi Oven and Grill	68
Oven	68
Temperature Control	69
Cooking Guidelines	70
Maintenance and Servicing	70
MICROWAVE OVEN	71
Accessories	72
Setting the Clock	72
Manual Operation	73
Auto Minute Function	74
Troubleshooting Chart	76
DOMETIC REFRIGERATORS	77

CONTENTS

Models RM8550, RMSL8500	77
Winter operation	77
Cleaning	77
Operating Modes	77
Electrical Operation	77
Gas Operation	77
Appliances with Battery Ignitor	78
Door Locking	78
Freezer compartment	79
Positioning the storage racks	79
Exchange of the ignitors battery	79
Shutting off the refrigerator	79
Lighting	80
Maintenance	80
THETFORD TOILET	82
Introduction	82
Parts	82
Preparing for Use	82
Using the Toilet	83
Emptying	83
Cleaning and Maintenance	83
Waste Holding Tank	84
Winter Operation	84
THE DROP DOWN BED	85
BATHROOM ACCESSORIES	86
Eco Camel Shower Head	86
Bathroom Shower Tap	86
Mirrors	86
Remis Blinds	87
Remis Concertina Cab blinds	87
Usage of the front system	87
Usage of the side system	88



GENERAL	90-94
GRP Panels	90
Insulation	90
Running Lights	90
Polyplastic Windows	90
Rooflights	91
MPK Rooflight	91
Mini and Midi Heki Rooflights	91
Stainless Steel Sink	92
Tecnoform Doors and Worktops	92
JVC Speakers	93
Carpet	93
Taps	93
Upholstery	94
Table	94

7. NOISE VIBRATION & HARSHNESS 95-99

Thetford Linear hob,	95
Polyplastic Windows	95
Remis Cab Blinds.	95
Care & Maintenance	98
Winterisation /Storage	99
Winterizing.	99
Modifications and Spares	99

8. GENERAL CARE 100

Spares and After Sales	100
Caring for the Environment	101

9. USEFUL CONTACT DETAILS	103
----------------------------------	------------

10. NOTES	104
------------------	------------

GREAT

GUIDES

TO THE

GREAT OUTDOORS

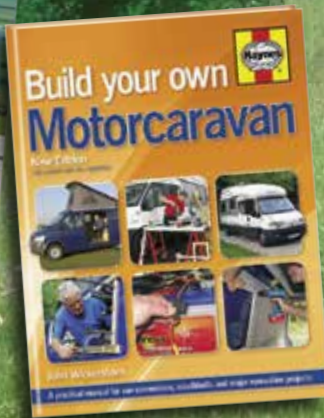

The Motorcaravan Manual (3rd Edition)

ISBN: 978 0 85733 124 3

£21.99

Build Your Own Motorcaravan (2nd Edition)

ISBN: 978 0 85733 281 3

£21.99

The Caravan Manual

ISBN: 978 1 84425 678 5

£21.99

Driving Abroad

ISBN: 978 1 84425 576 4

£12.99

Motorcaravanning Handbook (2nd Edition)

ISBN: 978 0 8 5733 264 6

£14.99

Prices correct at the time of printing



Follow us on:



www.haynes.co.uk

**Books for enthusiasts
by enthusiasts**



Available from all good bookshops or ORDER DIRECT on Tel: 01963 442030



**Bailey Owners
Caravan Club**

The Club, now over 40 years old, founded on friendship, fun and freedom, is run by and for the members and is dedicated to the hobby of rallying with Bailey caravans and motorhomes.

Rallies may be small or large, run for a specific purpose with a diverse range of activities. Biennially Bailey open the factory exclusively for Bailey Owner's Club members. We fundraise for a range of charities throughout the year.

It couldn't be easier to join - simply go to www.baileyownersclub.org for full details on how to become a member.



Welcome,

Congratulations on the purchase of your Bailey motorhome. We would like to welcome you into the ranks of Bailey owners. We are confident that this vehicle will give you many years of enjoyment.

This handbook has been designed to enable you to derive the maximum benefits and pleasure from your motorhome. Its information and hints will be beneficial and help to protect your investment whether you are a new or experienced motorhome user.

Information leaflets and literature on safe operation of appliances and equipment fitted to your motorhome are included in the Bailey Information pack. Please read these carefully prior to use.

Failure to observe recommendations or precautions could result in incorrect operation of equipment which could in turn lead to subsequent risk to occupants.

The information contained within this handbook will answer most of your questions. However, if there are any areas that we have failed to cover please do not hesitate to consult your supplying retailer. Supplementary user guides for certain components featured in this manual can be found in the brochure and handbook section of the company website at

www.bailey-motorhomes.co.uk.

Equally, make sure that the weight of a heavy accessory will not place the MTPLM of the vehicle at risk when you are loaded up for a trip.

Always consult your supplying retailer before additional equipment is fitted to ensure the location of appropriate structural support.

Retailers are not agents of Bailey and have absolutely no authority to bind Bailey by any express or implied undertaking or representation.

Happy Touring!

INTRODUCTION

FAMILIARISATION

This handbook is designed to familiarise you with your new vehicle from the moment that you step inside the habitation door and to describe the operating features.

Reading the handbook is made easy by the content being divided into sections.

At the back of the tilt and turn document you will find your service manual.

This handbook contains all the information that you will require for safe enjoyment of your motorhome. All the information contained herein is important.

Within chapters there are symbols that draw your attention to specific information:



WARNINGS are items that if ignored can cause the user(s) physical harm



Cautions are items that if ignored can result in damage to the motorhome



Notes are reminders that should be heeded.



To enable your queries to be dealt with more efficiently always quote your Approach Autograph's production number which can be found in the glove compartment on the Bailey weight plate as shown below.

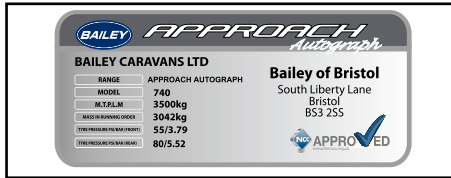

It is the policy of both Bailey and Peugeot to constantly improve their vehicles, so while all illustrations and descriptive matter in this handbook are intended to give a general idea of the motorhome and are correct at the time of going to press, changing market and supply situations may prevent us from maintaining the exact specification details of this handbook. Both companies therefore reserve the right to alter specification at any time without prior notice.

Bailey motorhomes offer a variety of customer uses and while each vehicle is designed to feature the optimum storage, seating, sleeping and fluid capacities, it is the driver's responsibility to select the correct loads without exceeding the weight capacities of your chosen vehicle. These weights can be found on the weight plate located inside your glove compartment along with the production number.



IMPORTANT SAFETY NOTES:

To ensure all the occupants of your motorhome enjoy a safe and relaxed environment please observe the following.

- Ensure all the occupants are aware of their escape routes in an emergency.
- Always keep escape routes and exit points clear from obstruction and debris.
- Provide one dry powder fire extinguisher of an approved type or complying with ISO 7465 of at least 1kg capacity by the main door, and a fire blanket next to the cooker. Familiarise yourself on your fire extinguisher and the local fire precaution arrangements.
- Your motorhome is a compact living environment, and appliances should be treated in the same way as those in the home to prevent any accidental burning or scalding - keep young children away from hot surfaces.
- Ensure the motorhome is serviced and maintained in accordance with this handbook as well as the base vehicle handbook. The recommendation of manufacturers regarding their appliances must also be followed. Also, ensure that any replacement parts for an appliance conform to the appliance manufacturer's specifications and should be fitted by them or an authorised agent.

Driving Licences

Never allow anyone without a valid driving licence to drive your motorhome.

CONFORMITY



All Bailey motorhomes have been certified by the National Caravan Council for compliance with UK and European Standards and Legislation along with industry Codes of Practice relating to health and safety issues. The approval process covers the testing and inspection of critical areas of the product from fire safety, weights and dimensions, to gas, electrics and ventilation. Every Bailey motorhome carries the "NCC Approved Motorhome" badge. The NCC conducts unannounced inspections at their members' factories to ensure continued compliance. NCC approval gives you peace of mind that your motorhome is legal and safe.



Your Bailey motorhome is European Whole Vehicle Type Approved. This assures you that your motorhome meets all European regulations and has been constructed to conform to these rigorous standards for both manufacturing and product safety. This allows you to register your vehicle in another European country. Your certificate of conformity is in the document pack provided with your vehicle.

Inside your motorhome there are three certificates for type approval, the Peugeot Certificate, the AL-KO Certificate and the Bailey Certificate of Conformity. Your retailer will have needed all three of these certificates to register your motorhome with the DVLA. If for any reason you need another certificate your Bailey motorhome retailer is responsible for accessing one through the NCC system. Please refer back to your retailer for additional copies.

INTRODUCTION

SECURITY

Theft

The theft of a motorhome can occur in the most unlikely circumstance; from a motorway area, even from an owner's driveway.

Secure all windows and doors when your motorhome is unoccupied even if only for a short while.

Additional Security

There is a vehicle identification number in the bottom right hand corner of the front windscreen of your motorhome. Keep a copy of this number in the front of this handbook. Do not leave the handbook in the motorhome for extended periods of storage.

Consider fitting any device that may deter or prevent intrusion by thieves. A wheel lock prevents removal of the wheel.

Advice about securing your motorhome, protecting your valuables and property marking, either at home or while on site, can be obtained from your local Crime Prevention Officer through your local Police Station.

i Important Terminology

MODEL: This handbook refers to all of the Peugeot-based Approach models built on an AL-KO chassis.

Gas System: This system is for use on vehicles with a 30mb gas system. The gas system pressure is noted on a label inside the gas locker.

Conversion Type: Your vehicle is classed as a coach-built motorhome made with insulated laminated panels with a GRP outer skin. (Type Approval class M1 SP.)

Climatic Conditions: The Approach SE range of motorhomes is designed for use in extreme temperature climates and has been tested to Grade 3 in accordance with EN1646-1:2004.

Handbook: Any queries should be addressed to your Bailey retailer.

Appliance Instructions: The appliance instructions have been extracted from those supplied by the appliance manufacturer.

Automotive - Peugeot: For all your Bailey motorhomes' automotive requirements please refer to the Peugeot vehicle instruction handbook or your local Peugeot retailer.

Tyre Pressures:

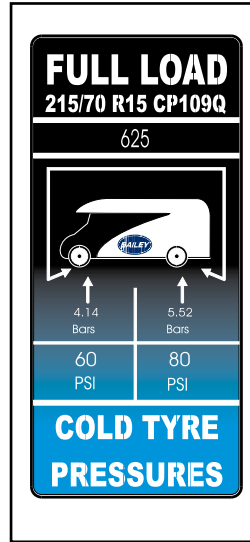

Your Bailey motorhome is fitted with Michelin Agilis Camping tyres. These tyres are designed to run at 80 Psi on the rear axle for all loads when used in a single fitment. The front tyre pressure can be set depending on the maximum in service vehicle loads. The correct cold tyre pressure for your vehicle is labelled on the inside of the passenger door frame. The tyres are 215/70 R15 CP 109Q.

Chassis Number: Record both the chassis number and the production number of your motorhome and store them safely at home. The chassis number is a 17-digit number which can be found:

- On a small "window" in the bottom left hand corner of the front windscreen.
- On the plate under the bonnet.
- On the European Whole Vehicle Type Approval plate which can be found in the gas locker.

You will find:

- The plate under the bonnet relates to the base vehicle data and may be replaced with an AL-KO plate if the weight has been upgraded.
- The motorhome conversion plate can be found inside the glove box. The production number is found on the plate and is another alphanumeric code of 17 digits. Above the production number you will find the MTPLM and MRO information.
- There is also a helpful weights and dimensions label that is under the driver's sun visor.

Production number: This is an alphanumeric code and is found in the glove box.



BAILEY WARRANTY

If you have a problem or enquiry relating to your motorhome please follow these steps:

- Check the handbooks.
- Contact your supplying retailer for assistance.
- The following suppliers provide a direct aftersales service; please contact them directly:

AL-KO

Al-KO Kober Limited
 South Warwickshire Business Park
 Kineton Road
 Southam
 Warwickshire
 CV47 OAL
 Fax: 01926 818562
 email: mail@al-ko.co.uk

DOMETIC

Dometic UK Ltd
 Dometic House
 The Brewery
 Blandford St Mary
 Dorset
 DT11 9LS
 Telephone: 0844 626 0130
 email: technical@dometic.co.uk

It is with the retailer that the purchaser's Contract of Sale exists and consequently Bailey of Bristol cannot enter into any discussions with the purchaser.

All Bailey products are classified as "portable". All work under warranty requires that the motorhome be delivered to and collected from the Bailey retailer.

While every effort is made within this handbook to accurately reflect and describe our home market motorhomes (those purchased and stored on the mainland) our policy of continued improvements and change in market and supply conditions mean that we reserve the right to alter specification without further notice. Some materials used in the production of our motorhomes can result in variations to the figures quoted in respect of measurements and weights.

Motorhome Warranty Cover

Total satisfaction is the top priority at Bailey and the quality ethos extends to the after-sales service and manufacturer's warranty that comes with every new Bailey motorhome. In this way we not only ensure long-term peace of mind but also enhance the resale value of your investment.

Your Bailey motorhome has three warranties 3 Year Base Vehicle Warranty - Provided by Peugeot

The Bailey motorhome is a coach-built model which utilises a Peugeot base vehicle. Peugeot provides a manufacturer's warranty for the base vehicle supplied which is subject to the terms and conditions laid down in

WARRANTY

their handbook. All enquiries relating to this warranty should be directed to your local Peugeot Service Agent.

6 Year Bodysell Integrity Guarantee - Provided by Bailey

The Bailey Alu-Tech motorhome is covered by a six (6) year Bodysell Integrity Guarantee. This cover extends to any structural degradation to the bodysell that arises as a result of water ingress through any permanently sealed seams or joints with the exception of exclusions stated in the terms and conditions.

The following item is covered for three (3) years from the date of first registration

- Colour fastness of motorhome habitation area bodysell panels

Warranty Extension

An additional four (4) year extension to the standard Bodysell Integrity Guarantee cover (making 10 years' cover in total) is available as a cost option. Please ask your supplying Bailey retailer for more information.

3 Year Manufacturer's Warranty - Provided by Bailey

For a period of three (3) years from the initial date of purchase, Bailey offers a comprehensive warranty on all parts and components used in the construction of the Bailey motorhome chassis and habitation area, as well as full coverage for any manufacturing faults forming part of the original specification of the Bailey motorhome with the following specified exceptions:

WARRANTY

The following items are covered for one (1) year from the date of first registration

- Leisure batteries
- Microwave ovens
- Pioneer stereo radio/CD/MP3 players & speakers

The following items are not covered:

- Replacement bulbs, light emitting diodes, fluorescent tubes or fuses
- Window blinds and door blinds
- General maintenance.

Warranty Extension

An additional three (3) year extension to the standard Manufacturer's Warranty cover for mechanical and electrical components of a leisure vehicle both external and internal (making 6 years cover in total) is available as a cost option. Please ask your supplying Bailey retailer for more information.

Customer Support

In the unusual event of something going wrong your first contact should always be your supplying retailer. Approved Bailey retailers enjoy industry-leading after-sales support service from the manufacturer and they should be able to offer all the help you need to rectify any problems that may exist. It should be noted that Bailey retailers sell our products of their own choice and not as agents of Bailey. Accordingly they have no authority to bind Bailey or make representation or undertaking whatsoever on behalf of Bailey.

Terms and Conditions

Defects in the base vehicle are covered by the

base vehicle manufacturer's warranty and any issues with it should be referred to one of the base vehicle manufacturer's agents.

The Bailey Warranty Cover set out above is offered subject to the following simple terms and conditions.

Cover

• During the term of the Warranty Cover, subject to these terms and conditions, Bailey will, through an Authorised Service Centre, at its option repair or replace all parts and components of the Bailey motorhome that are included in the Warranty Cover and which suffer a defect in manufacturer or workmanship. An Authorised Service Centre means either Bailey itself, a Bailey Approved Retailer or a Bailey Approved Service Centre. Any part which is replaced becomes the property of Bailey. Any replacement parts are covered for the unexpired term of the Warranty Cover.

Term

- The initial duration of the Bodyshell Integrity Guarantee is six (6) years extendable to ten (10) years and the duration of the Manufacturer's Warranty is three (3) years extendable to six (6) years, in both cases starting from the original purchase date of the Bailey motorhome. It is a condition of the warranty that an annual service is performed on the Bailey motorhome in accordance with the service plan. Failure to comply with this term will invalidate the warranty.
-
- The unexpired term of the Warranty Cover

on your Bailey motorhome may only be assigned, transferred or novated to subsequent owners with Bailey consent (not to be unreasonably withheld) and on payment to Bailey of a transfer fee of £35. Transfer can only be made within the first (3) months of subsequent ownership and full documentary evidence that the Bailey motorhome conversion has been serviced annually must be provided at the time of assignment in accordance with the terms and conditions detailed above.

Repairs

- The Bailey motorhome must undergo a full annual service and inspection, including a moisture survey, carried out, subject to the conditions specified below, by an Authorised Service Centre. The final annual service in the warranty period must be carried out before the end of that warranty period, but all other annual services may be carried out within six (6) weeks either side of each anniversary of the original purchase date. The original VAT invoices must be retained as proof that these annual inspections have been carried out.
- During the first three (3) years of the Warranty Cover, all annual inspections and repairs must be carried out either by Bailey itself or by an approved Bailey Service Centre or Agent. Thereafter, due to the technical nature of an Alu-Tech constructed Bailey motorhome, annual inspections and repairs may be carried out by any workshop or repair centre approved by the National Caravan Council that has attended Alu-Tech

training courses at the Bailey factory.

- Where an annual inspection identifies that repairs to the Bailey motorhome are necessary, the Bailey motorhome must be made available for repair within six (6) weeks of the date of inspection for the purpose of carrying out the repair work.
- No repairs, including the fitting of any replacement unit, may be undertaken or commenced under the terms of the Warranty Cover unless prior written authorisation is obtained from Bailey via an authorised Bailey retailer or Service Centre. No liability will exist with regard to any warranty claims not authorised in this way.
- Bailey reserve the right to examine the Bailey motorhome before any repairs commence or any replacement part is fitted.

Registration and Use

- The Warranty Registration Form must have been sent to Bailey within six (6) weeks of the original purchase date. It is the responsibility of the Bailey retailer to forward this information to Bailey. This is part of the terms of trading that the Bailey retailer has with Bailey.

The Bailey motorhome shall:

- Only be used for its original and intended purpose and shall not be subjected to any treatment or conditions which could reasonably be foreseen to cause or result in damage to the Bailey motorhome or excessive wear and tear.

- Not be put out to hire, reward or any other commercial use, nor used in any race, competitions or rallies whether timed, official or otherwise.

Exclusions and Liability

- Bailey's liability under this warranty shall be limited to supplying the reasonable cost of labour and materials required for repair or replacement of faulty parts or components. Bailey shall be entitled to charge for any repair work which is necessitated by virtue of any loss or damage caused by its owner's negligence or default or incurred as a result of any modifications made to the Bailey motorhome. This warranty does not cover repair costs other than labour and materials.

The Warranty Cover does not include

- Repair or replacement of parts, components, seams or panels which are not part of the original construction of the Bailey motorhome, or which have been tampered with or undergone unauthorised modifications, or which have been repaired otherwise than by an Authorised Service Centre.
- Parts or components other than those specifically listed in the Bodyshell Integrity Guarantee and Manufacturer's Warranty descriptions set out above.
- General maintenance or components failing due to fair wear and tear or normal deterioration.
- Repairs necessitated by lack of routine or regular maintenance. Particular attention is drawn to the owner's handbook and service handbook supplied with the

WARRANTY

Bailey motorhome and any maintenance instructions or notices published from time to time by Bailey relating to the proper care and maintenance of the Bailey motorhome.

- Structural degradation or other damage caused by water ingress through non-permanently sealed seams or joints (such as, without limitation, around windows, hatches, doors and rooflights), beyond the initial 24 months of the Manufacturer's Warranty.
- Maintenance activities including the adjustment of doors, catches and window blinds, servicing of appliances or cleaning.
- Maintenance activities related to the reduction of noise vibration and harshness.

No Liability will be accepted for:

- Damage caused by neglect or abuse, corrosion, intrusion of foreign or deleterious substances, lack of servicing, over-heating, freezing, or the continued use of the Bailey motorhome after a fault has become evident.
- Any loss or damage caused by parts not covered by this Warranty Cover, including soft furnishings or trim.
- Any accidental or fire damage or any losses incurred by accident or fire.
- Transport costs to and from point of repair.
- Damage caused by animals, rodents or other pests.

Bailey will only be liable for costs which are incurred as a direct consequence of the event, defect or fault leading to the claim being made under warranty. No liability will be accepted for any loss or damage (such as loss of income or revenue, or loss of business or profits), costs,

WARRANTY

expenses, or other claims for compensation howsoever arising which was not reasonably foreseeable by both parties when the Bailey motorhome was originally purchased. Bailey will not be liable for any loss or damage suffered by third parties, nor for bodily injury caused by the company's negligence.

Nothing in this warranty shall limit in any way Bailey's liability for death or personal injury caused by their negligence or fraud or fraudulent misrepresentation or for any matter for which it would be illegal for us to exclude, or attempt to exclude.

The purchaser has statutory rights in addition to this warranty and this warranty does not affect those statutory rights.

This warranty shall be governed by and construed in accordance with the laws of England and the parties irrevocably submit to the non-exclusive jurisdiction of the courts of England.

Warranty Registration

The supplying retailer must explain the warranty terms and conditions to you, and complete the warranty registration process on-line. Your warranty will start on the day that the vehicle is first registered in the UK or 12 months from the date on which the vehicle was invoiced to the supplying retailer, whichever is the earlier.

The name and address of the warranty and guarantee provider is:
Bailey Caravans Limited, South Liberty Lane,
Bristol, BS3 2SS

DRIVING LICENCE



Before you drive or allow any other person to drive your motorhome you must check your/their driving licence against the criteria of your particular vehicle.

Category B

With this category on your driving licence you can drive vehicles with a MTPLM of up to 3500Kg, with eight passenger seats, and with a trailer no heavier than 750Kg.

It's also possible to tow a braked trailer heavier than 750Kg if the MTPLM of the vehicle and trailer together is no more than 3500Kg. The trailer must also be lighter than the vehicle towing it.

To tow a heavier trailer than mentioned above you'll need category B+E.

Category C1

With this category you can drive vehicles with a MTPLM over 3500Kg but less than 7500Kg with a trailer no heavier than 750 Kg. To tow a heavier trailer you'll need category C1+E.

Category C

With this category you can drive vehicles with a MTPLM over 3500Kg with a trailer no heavier than 750Kg. To tow a trailer that weighs more than 750Kg you'll need category C+E.

Vehicle classifications

Motorhomes up to 3500Kg MTPLM are P/LGV (Private Light Goods Vehicles); motorhomes with a MTPLM over 3500Kg and up to 7500Kg are P/HGV (Private Heavy Goods Vehicles).

These are normally used in defining MOT classifications and vehicle excise duty (road tax) classifications.

Please refer to the website:

<https://www.gov.uk/calculate-vehicle-tax-rates> for the latest rules and regulations.

GENERAL ADVICE



ADVICE ON TOWING

The towing specification alters depending on the vehicle's weight.

Towing requires sensible loading of both the motorhome and the towed object.

When towing, the demands on both the driver and the vehicle are increased. When towing, manoeuvrability is reduced together with the ability to climb gradients and accelerate. Braking and vehicle handling are also affected.

It is essential that the driver is alert at all times.

- Pull over if you feel tired and get some rest.
- Brake in good time and take special care when driving down steep gradients.
- Use your gears and change down before going down a steep hill so that the engine also acts as a brake.
- Ensure that the tyre pressures are correct on both your motorhome and the towed object.
- Regularly check the towed object's brakes and lights.

When loading the trailer ensure that the loads are properly secured for transit.

- Position loads so that most of the weight is placed close to the floor and, where possible, immediately above or close to the axle(s).
- Where the load can be divided between the towed object and the motorhome it is advisable to load more into the motorhome as this will greatly increase the stability of the combination.
- After loading always check the maximum weight does not exceed the manufacturer's

recommendations.

- Check the front and rear axle weights of the motorhome are not exceeded due to loading the trailer. The easiest way to do this is to take the vehicle to a weighbridge.



Towing regulations vary depending upon the country you are visiting. It is important that you make yourself aware of each country's regulations before you visit.

- Do not exceed the motorhome gross vehicle train weight.
- Do not exceed the maximum front and rear axle loads on the motorhome.
- Motorhomes with a MTPLM up to 3500Kg which have European Type Approval can only be fitted with a Type Approved tow bar complying with 94/20/EC.
- The limit for towing an un-braked trailer is 750kg (based on VIN plate not actual weight): this applies to a towed car.
- The maximum permitted vehicle combination length is 18.75m. However, any combination must ensure compliance with the turning circle requirements of Construction and Use regulations 1986 and 97/27/EC.

Motorhome Code

The country and coastal codes

Upon arrival at your destination you should be aware of the Country Code relating to motorhome owners. This is entitled the Motorhome code.

Code of Conduct - Camp sites

Check the site regulations.

Arrivals

- Report to reception immediately on arrival.

Vehicle Movement

- Keep to roadways unless otherwise directed.
- Adhere to speed limits. Note that these are generally 10 mph while on site. (Remember that the stopping distance on grass is considerably greater than on tarmac.)
- Only a person in possession of a current driving licence may drive on site.
- Park as advised on your pitch. Where possible leave 6 metres (20ft) of free space around your vehicle.

Selecting a site

- Carefully select where you wish to park your motorhome.
- The site should be as level as possible, well drained and away from boggy areas, and preferably not under or near to trees.
- Consider how you will move your motorhome when you are leaving site; for example on sloping ground in wet conditions, pitch facing downhill.
- It is important to site your motorhome level so as to ensure the correct operation of the refrigeration, cooker etc, by using purpose-

made ramps and NOT bricks or such items.

Use of Site



- Use the electrical mains hook-up in the correct manner and with caution.
- Ensure that all fresh water taps/connections are turned off after use.
- Have care and consideration when using all facilities (toilets and showers etc) and leave them clean and tidy. Young children should be escorted.

To avoid possible damage to sewage purification works, only approved chemical fluids must be used. Under no circumstances may coal tar, phenol or caustic-based fluids be used.

Disposable napkins and similar bulky items must not be put into the chemical closet emptying points but should be wrapped in a polythene bag and placed in the container provided. (Put all litter in containers marked for the purpose.)

Noise

- Do not make excessive noise.
- Children should be restrained from making excessive noise.
- Flying kites and model aircraft and the use of items like catapults or air guns as well as ball games should not be permitted among, or close to motorhomes.
- Musical instruments, music players, radios and televisions should not be used to the inconvenience of other people on site.
- Open and close doors quietly.
- Power generators must be adequately

silenced and used with consideration and according to restricted site times.

Dogs and Pets

- All dogs and other pets should be kept under control.
- Unless permission has been granted, no animal should be let loose on the site and leads should not exceed 3 metres (10 ft).
- No animal should be allowed in the shower/toilet block.
- Do not let animals foul the site.

Fire Precautions

Adhere to and make note of all fire precautions including the whereabouts of the fire points.

It is recommended that a 1Kg (2lb) dry powder fire extinguisher is carried. It should comply with BS 5423 and be marked BSI or FOC approved. It is important to check at regular intervals that the extinguisher is working as is required by types meeting BS 5423. Make sure that the use-by date is frequently checked.

Careful thought is necessary for the positioning of a fire extinguisher, which should be near to the door but not too close to the cooking equipment where sudden flames could make it unreachable. In the kitchen area, a fire blanket is a worthwhile precaution.

Unless permission has been granted barbeques should not be used. When permission has been given, consideration should be given to the annoyance that can be caused to other users of the site. Open fires are not allowed.

Awnings and tents

Awnings and tents should only be used when

permission has been granted. When on grass and staying for more than a few days, the ground sheet and/or side flaps of awnings should be periodically raised in order to avoid damage to the ground.

Departure

- Leave the pitch clean and tidy.
- On leaving check out with reception, paying the required dues.

Wild Camping

Camping away from licensed sites, without the permission of the land owner or his/her agent, is not allowed in the United Kingdom. When permission has been granted, all aspects of this code should be adhered to.

On no account should:

- Litter be disposed of other than in the receptacles provided.
- Water be allowed to escape from the vehicle.
- Chemical toilets be emptied except into the disposal places agreed with the landowner.
- Washing or similar to be hung outside of the vehicle.

Parking

Motorhomes should only be parked in approved places.

When using the facilities of a motorhome, care and consideration should be given to other camp site and car park users.

Driving

When using a motorhome on either the public highway or a private road, the Highway Code should be complied with and full consideration

GENERAL ADVICE

given to other road users. In the event of a motorhome travelling slowly and there being a queue of traffic behind, the driver of the motorhome should, where possible, pull over in order to let the other traffic pass.



When the vehicle is in motion it is compulsory that all passengers are seated and seat restraints worn.

Before moving off, close rooflights, and top hinged windows. Likewise all doors and access lockers for gas containers and chemical toilets must be properly closed.

When the vehicle is being refuelled, or is on a ferry, all gas systems must be turned off at the gas supply cylinder.

Gas appliances should only be used when the vehicle is in motion if the appliance has an en-route facility built in.

Handbook

Before using a motorhome, all aspects of the handbooks produced by the base vehicle manufacturer and the habitation manufacturer should be read and adhered to.

Environment

Care and consideration should be taken to protect the environment.

Observe the Country and Coastal Codes shown overleaf.

The Country Code

Enjoy the countryside but respect its life and work.

More people than ever before are exploring the countryside, interested in farming, plant life, bird watching or just observing the general wildlife. Whatever your interest, there is a lot to learn, but please observe the following code. Guard against all risk of fires. Hay and heath land catch alight easily and once ablaze are very hard to put out. Remember fire spreads quickly.

- Keep to the public paths across farmland.
- Use gates and stiles to cross fences, hedges and walls.
- Leave livestock, crops and machinery alone. View from a distance.
- Take your litter home; it is unsightly and harmful to wildlife.
- Help to keep all water clean.
- Take special care on country roads.
- Make no unnecessary noise. Most animals are timid; noises can disturb them unnecessarily. If you want to get the best out of the countryside, travel around as quietly as possible.

The Coastal Code

As our coastlines are increasingly used for recreation and education, the following suggestions are made to enable us to enjoy our inheritance and preserve it for posterity.

- Do not trample about, or move rocks unnecessarily.
- Do not frighten seals or sea birds.
- Do not spear fish.
- Do not spill detergents, solvents or fuel from

boats as these can kill marine life.

- When using a boat, moderate your speed; the wash from a fast boat can destroy both banks and nests.
- Live molluscs and crustaceans need not be collected as souvenirs - dead shells can usually be found.
- Shellfish can take years to grow and fines can be imposed for not observing national regulations.
- Do not pull up seaweed unnecessarily.
- Make your visit instructive, not destructive.
- Look at material, don't remove it. Take notes and photographs, not specimens.
- Observe bye-laws and be considerate to others.
- National Trust property or Country Parks have regulations to protect the wildlife. Follow these.

Preparing for the road
Your Motorhome (Weights Explained)
Mass in Running Order (MRO)

This refers to the weight of your motorhome as it leaves the factory complete with its standard fixtures and fittings, as well as:

- 90% of the automotive fuel
- Driver (at 75Kg, 11st2lb)
- The LPG cylinders 90 % full
- The water heater 90% full
- The fresh water tank 20% full
- The waste water tank empty
- The toilet flushing tank, full
- The toilet holding tank, empty.

Any additional passengers/equipment are

excluded from the MRO and need to be taken into account when calculating your available payload.

Maximum Technically Permissible Laden Mass (MTPLM), (sometimes referred to as GVW Gross Vehicle Weight)

The maximum allowed weight of the vehicle when it is fully laden for use on the road. See your Service Manual for exact specification.

User Payload

The load margin (payload) is the difference between the Mass in Running Order (MRO) and the Maximum Technically Permissible Laden Mass (MTPLM). This shows the maximum weight that can be loaded into your motorhome; it covers items such as optional extras, clothing, food, crockery, cutlery, bedding etc. Please see your Service Manual for exact payload figures.

Please take care to ensure that you have allowed for the masses of all items you intend to carry in the motorhome, e.g. passengers, optional equipment, essential habitation equipment as well as your personal effects such as clothing, food, pets, bicycles etc.

Your passengers' weight should also be taken into consideration when loading your vehicle. Please refer to your MRO and MTPLM.

You may wish to allocate the user payload to suit your own use. For example, to increase the available payload, the water system may

be emptied. If the vehicle is not being used for camping, the gas cylinders can be left at home to increase the mass available for other items. **Gross Train Mass (GTM) (sometimes referred to as GVW)**

If you are towing a trailer with your Bailey motorhome the gross train mass is the MTPLM of the towing vehicle, the trailer and the mass of every item carried. The GTM is specified by the base vehicle manufacturer (AL-KO) and is unaffected by the Bailey conversion. Please check your driving licence to ensure you are allowed to drive a vehicle combination at this weight.

Maximum Braked Trailer Mass (MBTM)

This is the maximum allowable weight of the trailer together with its load, provided the trailer has a braking system, which complies with the local Construction and Use Regulations. The MBTM is given by the base vehicle manufacturer (AL-KO) and is unaffected by the Bailey conversion.

Nose Weight

This is the static mass of the trailer towing device on the rear of the towing vehicle.

- When measuring nose weight it is important that the trailer is loaded.
- The trailer is intended to be towed slightly nose heavy. The nose weight can be adjusted by redistribution of the load. The nose weight should be approximately 7% of the actual laden weight (but not greater than the hitch capacity) and at the same time suit the motorhome requirements.

Axle Loads

The individual axles also have upper limits. The sum of the two axle upper limits usually exceeds the overall vehicle MTPLM, but this does not mean you can load each axle to its maximum, because doing so would exceed the overall MTPLM of the whole vehicle.

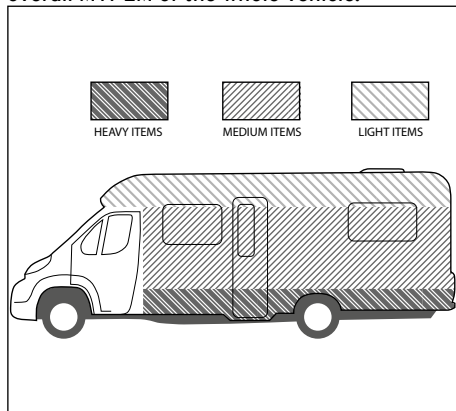

Loading and Distribution of Weight in the Motorhome

Loading

Loads must not be exceeded. The driver is responsible for arranging the loads so that they comply with the technical weight limits of the specific motorhome model. See specification in the service manual.

Correct weight distribution is a major factor in making your motorhome a balanced and pleasant vehicle to drive without compromising road-holding. Care should therefore be taken to ensure that heavy items are well spaced

GENERAL ADVICE

and are in as low a position as possible, for example, low cupboards and bed boxes.



Do not travel with microwaves or televisions in overhead lockers unless the appliance was supplied fitted by the vehicle manufacturer. Do not exceed the maximum stated load. Items fitted other than standard equipment will deplete the payload stated in the service manual.



Under no circumstances should the maximum technically permissible laden mass be exceeded.



Roof loading: Do not allow children to climb on the roof of your motorhome.

Roof rack bars and ladders are optional and if you are considering them, care should be taken to ensure that all items can be safely secured. Apart from general cleaning and polishing you should also enquire what other maintenance is required.



Take special care when on the roof particularly in wet or frosty weather conditions, as the surface could be slippery. Always wear practical footwear when climbing onto your vehicle.

Maximum load within the area encompassed by the roof rack should not exceed 75Kg (165lb) with a maximum loading of 24Kg per meter² (8Kg (17lbs) per square foot.)



Before Moving Off

Whenever you are making a journey with your motorhome, either setting off or returning from holiday, it is good practice to run through this simple list.

- Close and secure all cupboards and drawers and check any loose articles.
- Do not store tins, jars, cylinders, etc in overhead lockers.
- Close and secure all windows and rooflights.
- Leave all curtains and blinds open to aid visibility - the curtains surrounding passengers travelling in the rear of the vehicle can be secured via a press stud to ensure that the passengers' view is not obstructed.
- Check that gas cylinders are securely fastened and turn off all gas appliances, except those heating appliances that are designed to function while the vehicle is in motion. Also ensure that the gas locker door is securely fastened.
- Ensure that there is sufficient gas to meet your needs.
- Switch off 230V supply at the site's hook-up supply pillar; disconnect the mains cable from the vehicle. (Beware of a potential electric shock from a wet cable.) Coil cable and store in a safe place.
- Check both the control panel and the PDU box for operation. (The PDU box is similar to a fuse box found in a domestic house and can be found under the front bunk.)
- Check and, if necessary, charge your leisure battery.
- Check that the battery selection switch is in the OFF position.
- Check that the battery is secure and that

the battery box door is securely fastened.

- Ensure that the fridge is set to 12V operation and the door lock is set. (Please note that the electrical relays will allow the fridge to run on the vehicle battery when the engine is running.)
- Remove any external fresh water connections, coil and store in a secure place.
- Make sure any heavy articles are stored in accordance with the loading procedure.
- Ensure tables are in their specified storage compartments.
- Lock the motorhome's exterior door (remember to remove the keys).
- Check your external rear view mirrors and adjust if necessary.
- Check that the wheel nuts are secure and that the tyre pressures are correct.
- Ensure, if required, that your fresh water tank is full and your waste water tank is empty.
- Ensure that the toilet flush tank only contains a small amount of water (1-2 litres) in order to minimise the risk of leaks or spillage while the vehicle is in motion.
- Check underneath the vehicle for any stray items.
- Safely store your levelling blocks away in an appropriate place.



When travelling it is extremely important for you and your passengers' safety to store any table, be it freestanding or fixed to the wall, into its dedicated storage compartment.

DRIVING

Speed limits (UK)

If a speed limit is not in force, your motorhome can be driven up to 70 mph on motorways and 60 mph on dual carriageways.

Reduce Speed

- In high or cross winds
- Downhill
- In poor visibility.

High sided vehicles cause air buffeting so extra care must be taken when passing or being passed. Leave as much space as possible when passing or being passed.

Driving

- Do not bump the kerb.
- When passing other vehicles allow more room than the normal clearance you would allow when driving a car.
- Allow longer to get up to speed and pass.
- Do not swing out suddenly.
- Carry out all manoeuvres as smoothly as possible.
- Use nearside wing mirror to check that the motorhome has fully cleared a vehicle when overtaking.



While the vehicle is being driven please ensure that:

- Both the driver and passengers wear seat belts. This is a legal requirement.

- Heavy loads are not stored in top cupboards or in areas from which they may become detached. Please ensure that heavy items are stored low down and take care not to overload individual wheels, the axles or the MTPLM.
- Tables must be secured in their storage compartments.
- Cupboards and flaps are in the closed position and secured.
- The refrigerator door is closed and secured.
- Roof ventilators are closed and locked in the down position.
- The bathroom is not used while the vehicle is motion.
- Top hinged windows are closed and securely fastened.
- All passengers are secure and wear the appropriate restraint for their height and age.

Front Seat Swivel

The cab seats swivel for convenience when you are on site. However, when the vehicle is being driven they **MUST** be locked in their forward position.



Wheels

In the event of a puncture, ensure that the replacement wheel is of the same construction and size as the one that is being removed. The tyre pressures must be suitable for the use to which they are being put. The minimum tread depth must be 1.6mm throughout a continuous band comprising the centre three-quarters of the breadth of the tread and around the circumference of

the tyre.

The correct tyre pressures are displayed on the inside of the driver's door.

Dedicated travelling passenger seating

Seat belts are fitted to all travelling seats. Designated travelling seats have been fitted to some layouts to ensure the safety of your passengers. These seats vary according to the layout that you have purchased. Each seatbelt frame is tested to the relevant safety requirements.



NEVER travel in or attempt to install a seat belt to a non-designated seat.

Side-facing seats are for habitation use only, not for use when the vehicle is in motion.

Seat Belt Legislation

Seat belts must be worn when the vehicle is in motion by the driver and all adult passengers. In addition, children, aged up to 3 years of age, must wear an appropriate child restraint such as a child or booster seat suitable for their age and weight. Children over 135 cm (4'5") in height or aged over 12 years must wear a seat belt.

It is the legal responsibility of the driver to ensure children aged up to 14 years old are suitably restrained. For passengers aged 14 and over, it is their responsibility (not the driver's).



Seat belts are fitted for you and your passenger's safety and must be worn unless you have a 'Certificate

GENERAL ADVICE

of Exemption from Compulsory Seat Belt Wearing'. This certificate must be produced if asked for by the police - seat belt offences may result in a fine.

Child seats

Positioning/Fitting

Dependent upon the child seat type, the most suitable position for a child seat to be fitted may be the front passenger seat of the cab (NOTE: Follow the airbag advice) or the window seat of the forward-facing rear seat. The aisle seat in the rear is not a recommended position. Advice should always be taken from the retailer on the suitability and security of the seat in the motorhome.

All of the motorhomes are fitted with inertia seat belts; however, the child seat must be tight in the adult seat. Push all your weight into the child seat as you tighten the belt. Keep a copy of the child seat fitting instruction in the motorhome for easy reference.

Airbag



Never fit a rear-facing child restraint in a seat with an active airbag in front of it.

Forward-facing child restraints should be positioned as far back from the airbag as possible. Check the base vehicle handbook.

Three point seat belts located in the habitation compartment of your motorhome.

Fastening the seat belt.

Insert the buckle into the plug-in socket until it clicks. The clicking noise will indicate a correct assembly.

Releasing the seat belt

Press the red release button; the buckle will be ejected from the plug-in socket.

- The belt is designed for one person and must not be put around a child seated on someone's lap.
- The belt is suitable for retaining most child seats and boosters.
- The belt should always be used according to these instructions and adjusted accordingly.
- Never wear a slack seat belt.
- When installed correctly the seat belt should pass across the centre of the shoulder and fix into the plug-in socket beside the hip.
- It is important that the strap is not twisted during use as this can cause damage.
- Webbing must not be allowed to rub against sharp surfaces as this could lead to strap damage. If a belt is showing signs of wear (frayed, damaged or stressed) it should be replaced.
- Always replace a seat belt after an impact.
- Always check the anchorage points after an impact; if these are deformed the seatbelt frame will need to be replaced.
- Never modify the belt.
- Inspect your seat belt on a regular basis.

Jacking

Position the jack in the hole provided as shown. Rear jacking points are located in the shock absorber mounts on the left and right, in front of the axle.

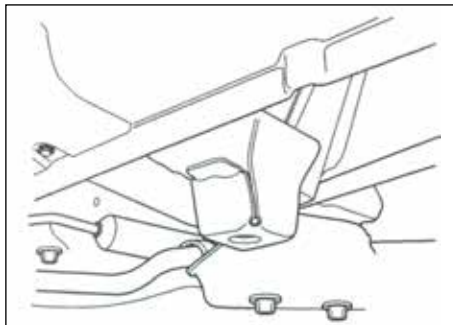

When changing a rear wheel raise the vehicle to the maximum extent of the jack. In order to clear the skirt when removing the wheel, tilt the bottom of the wheel under the vehicle and allow the top of the wheel to fall outwards and clear of the hub.

Reverse the procedure to fit the new wheel.

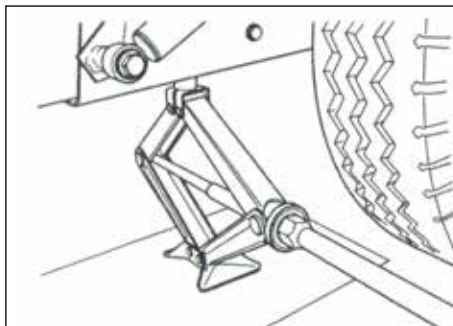

Removing the spare wheel

Changing the wheel

General Notes

Do not use the jack for loads that are greater than the load given on the jack rating plate. Ensure the vehicle is on a level, firm surface.

Changing front wheels

Select first or reverse gear.

Apply the handbrake and chock the remaining wheel.

Onboard tools and chocks are usually located underneath the driver's seat.

Changing rear wheels

Select first or reverse gear.

Do not apply the handbrake but fit chocks under the remaining wheels.

Onboard tools and chocks are usually located underneath the driver's seat.

Spare Wheel Location

The spare wheel is located at the rear under the vehicle floor.

The spare wheel carrier fitted in your vehicle is much like that fitted into modern cars.

To lower the spare wheel:

1. Remove the plastic stopper in the floor. Remove the winder from its storage location and insert the hooked end of the crank in the spare wheel retaining attachment.
2. Continue to lower the wheel by turning the crank anti-clockwise. Lower the wheel a little bit at a time and guide it until it is securely seated against the floor.
3. Draw the spare wheel towards you from under the vehicle.

- Pivot the toggle at the end of the cable 90° to release it from the spare wheel.

As a safety precaution have the flat tyre replaced or repaired before fitting back under the vehicle.

When the spare wheel is being used on the vehicle, the retaining cable could damage the underside of the vehicle if not retracted.

Crank up the cable again by turning the crank clockwise. (The wheel with the flat tyre can be stored on the carrier for transport purposes.)

Returning the spare wheel to the storage compartment

- Use the crank (turn it counter-clockwise) to lower the spare wheel's retaining cable. When there is no wheel attached, the cable will need to be gently pulled from the carrier during lowering to ensure the cable does not tangle inside the carrier.
- Pass the toggle at the end of the cable through the centre hole in the spare wheel. Pivot the toggle 90° so that when raised, the wheel will rest on the toggle.
- Retract the retaining cable slightly by slowly turning the crank clockwise several times.
- Position the wheel so that it is not obstructed by components under the floor.
- Continue to raise the wheel by turning the crank clockwise. Raise the wheel a little bit at a time and guide it until it is securely seated against the floor.
- When it is no longer possible to turn the crank any further check that the

spare wheel is seated tight against the underside of the floor and has not fouled on any component.

- Replace the plastic stopper inside the vehicle.



- The vehicle jack must only be used for changing a wheel.
- Under no circumstances should anyone be allowed underneath the vehicle when it is elevated on a jack.
- On no account should it be used for repair work under the vehicle. Never jack up the vehicle by the rear axle, front axle, oil sump or transmission.
- When working on a loaded vehicle, use a suitable hydraulic lift platform or work in an inspection pit. Always consider the centre of gravity of the vehicle. Before driving onto platforms, check for low lying vehicle parts.

Safety and Security

Important: your attention is drawn to the notice fixed in your motorhome advising on fire protection, ventilation and what to do in case of fire.

Children

Never leave children alone in the motorhome and keep potentially dangerous items out of reach as at home, e.g. matches, drugs etc.

When upper bunks are used by children, especially those under the age of 6, care should be taken to ensure against the risk of them falling out. These bunks are not suitable for the use of infants without adult supervision.

GENERAL ADVICE

Fire Extinguishers

It is recommended that a 1Kg (2.2lb) minimum capacity dry powder fire extinguisher be located near to the main habitation entrance door.

- A pan fire should not have a fire extinguisher aimed at it but be smothered with a fire blanket. This should be within easy reach of the hob but away from the source of flames.

In case of a fire

- Get everyone out of the motorhome as quickly as possible using whichever exit is nearest, including windows. Do not stop to collect any personal items.
- Raise the alarm.
- Call the fire brigade.
- Turn off gas cylinder valve if it is safe to do so.

Ventilation and Condensation



The ventilation points on your motorhome are fixed points of ventilation which are specified by European Standards. Under no circumstances must these be blocked or obstructed. It is advised that fixed ventilation points and any protective screens are checked and cleaned (if necessary) on a regular basis.

Fresh air circulation should be allowed below the motorhome when appliances are in use and when flues terminate below the floor to allow free evacuation of the products of combustion. At least three sides of the under-floor space should be kept clear and unobstructed

including by snow. Do not make any additional openings in the floor.



Additional night time ventilation is obtained by releasing the window catches and placing them in the second groove on the frame catch.

General

Before using your Bailey motorhome, you should be fully conversant with the following safety precautions; if you are in any doubt as to the meaning of any of them you should contact your supplying Bailey retailer. Please read the following carefully.

In the interest of safety, replacement parts for appliances must conform to the manufacturer's specifications and should be fitted by them or an authorised agent.

- Never use portable cooking or heating equipment other than electric heaters that are not of the direct radiant type, as it is a fire and asphyxiation hazard.
- Do not use cookers as heaters and do not dry clothes on the cooker or space heater.
- Make sure that combustible materials cannot come into contact with hot surfaces or burners.
- Surfaces of appliances may become hot in use and the guard provided does not give full protection to the young or the elderly.
- Do not use additional independent gas appliances inside the vehicle.
- Never allow modifications of the electrical or gas systems or appliances except by qualified technicians.

- Do NOT obstruct ventilation.

The heating system provided in your motorhome is of the "room sealed" type; any replacement should be of the same type.

Turn off all gas cooking appliances before travelling.

Ventilation openings are located below all the gas appliances, and in the base of the gas locker. In winter conditions make sure the vents are clear of both snow and mud. These openings should regularly be checked and any mesh covering them cleaned with a stiff brush to prevent any risk of them becoming blocked. The openings are provided for your safety - please do not obstruct them.

Bailey Approach Autograph fitted with MICHELIN tyres.



Visit www.michelin.co.uk for more information about MICHELIN tyres.





Morland[™]
FIT OUT PRODUCTS

Morland, Unit 2, Buttington Cross Enterprise Park,
Welshpool, Powys SY21 8SL
Tel +44 (0)1938 551 980 Fax +44 (0)1938 554 174
Email: info@morland-uk.com

Proud Suppliers To Bailey Of Bristol



visit www.morland-uk.com

AMC Chassis

Your vehicle is fitted with an AMC Chassis conversion supplied and fitted by AL-KO Kober Limited. As a result the base vehicle has undergone certain changes.

The original rear frame has been replaced by a hot-dip galvanised AL-KO lightweight chassis. This chassis is connected to the cab by means of a special bracket assembly.

The AL-KO chassis and AL-KO axle with torsion bar suspension is fitted in place of the original equipment manufacturer's chassis and axle.

Vehicles with an AL-KO chassis are approved for use with a trailer.

If fitting a tow bar, use one that has been approved by AL-KO and ensure it is fitted correctly.

When ordering a tow bar assembly, always indicate the vehicle type and the chassis number.

You should ensure that the maximum train weight as shown in the registration documents is not exceeded.

Towing a trailer also reduces the maximum gradient capacity (hill climbing ability) of the vehicle.

Suitable rear view mirrors, in accordance with road traffic regulations, may have to be fitted.

DRIVING INFORMATION/TRAILER USE

To achieve optimum results when towing a trailer, please observe the following points:

Refer to base vehicle handbook for towing limits.

Do not tow with the vehicle empty and the trailer loaded. If this is unavoidable, please drive slowly to allow for the unfavourable weight distribution.

Always locate heavy objects close to the trailer's axle and secure.

Observe all legal issues applicable to towing. Ensure tyre pressure of vehicle is set at fully loaded setting.

Use low gear when travelling downhill to avoid constant braking.

The electrical functions and the electrical circuit diagram will be found in the operating instructions supplied by the base vehicle manufacturer.

Repairs

Repairs to the AL-KO AMC components including the axle assembly may only be carried out by specialist workshops.

SAFETY EQUIPMENT



Smoke Alarm

The smoke alarm is operational once the battery is connected. When products of combustion are sensed, the unit sounds an alarm until the air is cleared.

Features

Battery operated.

The operating light (red LED) flashes every 40 seconds confirming that the unit is powered.

Low Battery Warning: the unit will emit an audible "chirp" once every 40 seconds for 7 days before the battery needs to be replaced. Failure to replace the battery will result in insufficient power to alert you in a real fire situation.

Sensitivity test button. This tests the sensitivity, circuitry, battery and horn.

Loud alarm.

Test smoke operation after the vehicle has been in storage, before each trip and at least once a week during use.

Your alarm requires one 9 volt battery. Under normal use, the battery should last one year.

Simple Maintenance

Clean your smoke alarm once every three months to help keep the unit working correctly. Gently vacuum using the soft brush attachment.

Problems are indicated by two events:

- The alarm does not sound upon pressing the test button.
- The operating light remains steadily on or off (i.e. does not flash every 40 seconds,

SAFETY EQUIPMENT

when the unit is not in alarm).

Try the following:

- Inspect for obvious damage.
- Check that the unit contains recommended battery type.
- Check that the battery cover has been removed.
- Check that the battery is properly connected.
- Gently vacuum as recommended above.
- Replace battery.

If these procedures do not correct the problem, do NOT attempt repairs; replace the smoke alarm.

Carbon Monoxide Alarm

A FireAngel CO-9B battery operated alarm is fitted near to the ceiling in your caravan.

Features

- An advanced electrochemical sensor designed to accurately measure low levels of carbon monoxide (CO) providing an early warning of toxic CO levels in your caravan.
- Detects carbon monoxide continuously.
- Resistant to false alarms caused by usual household contaminants.
- Sounds a large 85dB alarm (at 1 metre (3 feet)) to alert you in case of an emergency.
- Simple to mount, portable, ideal for travelling.
- Conforms to the British standards Institute (CSI) Carbon Monoxide Standard BS EN 50291: 2001.
- 7 Year Warranty.
- Test/Reset button feature.
- Test the sounder, batteries and circuitry.

- Allows you to test the sensor by introducing a source of CO into the detector.
- Silence the loud 85dB sounder during an alarm (only possible when current CO level is less than 50ppm).
- Testing the sounder batteries and circuitry.
- Test the sounder, batteries and circuitry by pressing and holding the Test/Reset button for 1 second to confirm that the detector is operating properly. The sounder should sound as soon as the button is pressed, and the alarm LED will illuminate red, indicating that the sounder is working and the batteries are providing power to the unit. The test for the sounder, batteries and circuitry should be performed weekly.

Testing the Sensor.

- All sensor testing should be carried out by a responsible adult. This test should only be performed once a month. Excessive testing will cause the battery life to be shortened.



CO testers may be used in order to avoid having to burn cigarettes, incense sticks etc.

Please read all steps thoroughly before attempting to test your alarm.

- If the alarm is wall mounted, remove by unhooking the unit from the wall fixing screws.
- Cover the sounder vents with one hand and hold the Test/Reset button down with your thumb/finger until the power LED illuminates green and the sounder sounds for a second time. (This should happen after 5 seconds.) Release the Test/Reset

button and the power LED will flash green once every second. This indicates that the sampling rate of the detector has increased and can be tested using a known source of CO.

- Light an incense stick or a cigarette using a match or a lighter. If using an incense stick, be sure to blow the flame out so that the incense stick is smouldering. Extinguish the lighter, or put out the match and place it into a dish of water.
- Turn the detector on its side so that the vents on the right hand side of the detector are pointing downwards. Hold the burning incense stick or cigarette around 15cm (6 inches) below the detector. An increase in the localised CO level within the sensor to more than 50ppm (parts per million, the accepted level of CO in the air) will cause the sounder to sound for one cycle of four loud beeps. The power LED will no longer flash green every second but will revert to flashing once a minute. The detector will revert to the ordinary operating mode (it may take up to 2 minutes for the localised level of CO to reach over 50ppm). Now move the source of CO away from the detector as the test is finished.
- Put out the incense stick or cigarette by placing it into a dish of water. Ensure all flames have been extinguished.



If the localised CO level within the sensor does not reach 50ppm during the test, the sensor test will stop automatically after 3 minutes.

Understanding your product's indicators

- The higher the concentration of carbon monoxide detected by the detector, the quicker it will respond. When sufficient carbon monoxide is detected a loud audible signal (85dB at 1m/3ft) will be emitted and the alarm LED will flash red once every second.
- The alarm will sound:
 - Within 60 and 90 minutes when exposed to 50ppm of CO
 - Within 10 and 40 minutes when exposed to 100ppm of CO
 - Within 3 minutes when exposed to 300ppm or more CO
- There will be an audible "chirp" if the battery, sensor or circuitry has any fault including a low battery. This sound will continue once a minute for 30 days. (The battery must be replaced to ensure occupant safety.)
- If the device continues to chirp despite having new batteries and the product is still in warranty then contact technical support for the device. If the device is no longer in warranty replace it immediately.

Maintaining/ testing your detector

Maintenance

- Your detector will alert you to potential hazardous CO concentrations in your motorhome when maintained properly. To maintain your FireAngel detector in proper working order and to ensure that the sensors will last for the lifetime of the product, it is recommended that you:
 - Test the sounder, batteries and circuitry of your detector once per week by pressing and

- holding the Test/Reset button for 1 second.
- Perform the sensor test annually.
- Keep the detector free of dust by gently vacuuming with a soft brush attachment when required.

To prevent the possibility of contaminating the sensor in your detector and thus affecting its reliability:

- Never use cleaning solutions on your detector. Simply wipe with a damp cloth.
- Do not paint the detector.
- Do not spray aerosols on or near to the detector.
- Do not use any solvent based products near to the detector.



Failure of any test should be reported to the manufacturer's technical support line.

0 800 1412561

Do not attempt to repair your CO detector. Do not remove any screws or open the main casing of your detector. Any attempt to do so may cause malfunction and will invalidate the warranty.

Never ignore any alarm.

What to do in the event of an alarm

- Keep calm and open all the doors and windows to ventilate your motorhome.
- Stop using all fuel burning appliances and ensure where possible they are turned off.
- Evacuate the motorhome leaving doors and windows open.
- Do not re-enter the motorhome until the

SAFETY EQUIPMENT

- alarm has stopped.
- Get medical help for anyone suffering the effects of CO poisoning and advise that CO poisoning is suspected.
- Close the windows and doors and do not use the motorhome again until you have had a full service of all appliances by your supplying retailer. In the case of gas appliances they must be tested by a GAS SAFE registered installer. Please contact your Bailey retailer for more details.
- The electro-chemical sensors used in the carbon-monoxide alarm have a limited lifespan - therefore it is recommended that a CO alarm is replaced every 5 - 7 years after manufacture or in accordance with the unit's instructions. Do to be sure check the manufacturing date on the alarm's label.

Please read and become familiar with the operating instructions for the equipment within your Bailey motorhome.

Connections of services are dealt with under three separate headings: Water, Gas and Electricity.

WATER SYSTEM

The Bailey motorhome is fitted with a fresh water supply system and a waste water system. All water hose used in the system is WRAS (Water Regulation Advisory Scheme) approved non-toxic food quality hose.

Fresh and Waste Water Tanks

In Autograph models both fresh and waste water tanks are positioned under the floor with the fresh water tank in front of the waste near to the rear axle. The drain for the fresh water tank is accessed through a hatch in the floor of the vehicle and then the plug can be pulled from the bottom of the tank draining all of the water. Both tanks have an inspection cap positioned on the top and accessed through an internal hatch in the floor of the vehicle.

To empty the waste water tank there is a tap positioned by the skirt on the offside of the vehicle behind the rear wheels. Move your vehicle to a waste water disposal point, open the tap and allow the water to drain.

On the Advance models there is an onboard water tank, beside the tank you will find the dump valve for when you wish to empty the tank.

On both models the drain from the waste water is on the offside of the vehicle near to the skirt, behind the rear wheel.

In the Autograph models both the fresh and waste water tanks have a capacity of 100 litres. The Advance models have a fresh water tank capacity of 90 litres while the waste is 100litres.

The water level indicator digital display is mounted within the control panel above the exterior door. There is an audible alarm when the fresh water tank is 25% and 75% full meaning that you are alerted before the tank runs out of water and also when it is near to overflowing.

Filling the tank Autograph models

Fill the tank through the exterior filler cap identified with a fresh water label. There is an overflow pipe on top of the fresh water tank. Water flowing from this indicates a full tank as does the full tank icon on the control panel.

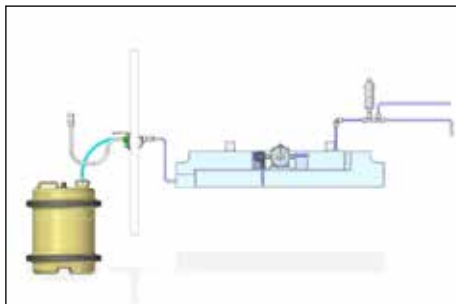

Filling the Tank Advance Models

Fill the tank, by removing the cap, and filling the system through the exterior filler, which is identified with the fresh water label on the exterior wall.

When the system is full, water will overflow from the filler neck.

When a tap is opened, water will flow under pressure, all the air has to be dispelled from the water system to enable the pressure switch to work properly, when the tap is turned off, the pump will switch off when the required pressure has been achieved.

Breathers

Both tanks are fitted with cleaning lids which also act as breathers for the water tanks. This allows for air displacement when filling. When filling the fresh water tank, water may escape through these breathers; this should give no cause for concern.

Baffles

For added stability and driving comfort the water tanks in your vehicle are fitted with baffles. These baffles stop the water from flowing freely from side to side and creating uneven weight distribution.

Frost Protection

Your fresh water tank is clad in a polystyrene insulating jacket that helps to stop the water from freezing in cold temperatures.

It is also fitted with a tank heater which operates when the temperature drops below -2°C. Should you wish to turn the tank heater off you will find the switch in the front of the van behind either the passengers or the driver's seat.

However, if the vehicle is not being used during freezing conditions the water must be drained.

Fresh Water Pump

A Whale Watermaster onboard pump is fitted to your vehicle. It will be located under the hatch in the floor and is accessible through the fresh water tank hatch.

Operating Instructions
WHALE TANKFILL SYSTEM

The onboard tank can be filled using either a Whale submersible pump or a whale Aquasource mains hook-up. The Whale watermaster pump is used to supply a pressurised water system to the taps and shower.

Filling the onboard tank.

The onboard tank is filled in one of two ways, either:

1. Using the Aquasource as supplied with the van.
(When a drinking water tap is available within approximately 7 metres of the vehicle.)
 - Lift the lid of the external Whale Watermaster socket.
 - Insert the Whale Aquasource plug firmly into the socket, and close the lid down [approximately 90°] until it locates and locks the Whale Aquasource plug into place.
 - Connect the other end of the Whale Aquasource to the water tap, and turn it on, making sure there are no kinks in the pipe run.
 - Turn off the tap when water flows from the overflow underneath, indicating that the onboard tank is full.

To remove the Whale Aquasource

- Disconnect the Whale Aquasource from the tap.

- Lift the lid of the Whale Watermaster socket, to the vertical position.
- Depress the two white location buttons on the Whale Watermaster plug, and remove from the socket.
- Close the lid of the Whale Watermaster socket, until it is located into position.
- Stow away the Whale Aquasource in a clean chemical-free area.

2. Using the Whale Submersible Pump

When a drinking water tap is not at hand.

- Fill a suitable water container, and place below the Whale Watermaster socket.
- Place the Whale Submersible pump into the water container; the pump should reach the bottom of the container.
- Lift the lid of the external Whale Watermaster socket.
- Insert the Whale Submersible pump plug firmly into the socket, and close the lid down [approximately 90°] until it locates and locks the Whale Submersible pump plug into place.
- The pump will then start automatically to fill the onboard tank.
- When the tank is full, the pump will turn off.



Please note that when the water container is empty the pump will continue to run and will eventually burn out.

To remove the Whale Submersible pump.

- Lift the lid of the Whale Watermaster socket, to the vertical position.
- Remove the Whale Submersible pump plug from the Whale Watermaster socket.

- Close the lid of the Whale Watermaster socket, until it is located into position.



Stow away the Whale Submersible pump in a clean chemical-free area, shaking any loose water from the unit first.

It should be noted that as the container volume is likely to be less than that of the onboard tank, it is advisable to remain in attendance when filling the tank, as the life of the pump will be drastically reduced if allowed to run dry. To fill an onboard tank to the brim you normally have to repeat this procedure several times: To continue the filling of the onboard tank should the water container volume be less than that of the onboard tank. Repeat the operations described immediately above. Use the Whale Submersible pump, removing the pump from the Watermaster socket each time.

Using the Whale Watermaster Pressure Pump

The water system can be primed as follows, after the onboard water tank has been filled.

- Switch on the ancillary power supply to the pump at the main panel.
- Open one hot tap, e.g. kitchen sink.
- Water will flow from the open tap after filling the water heater. This could take a few minutes if the water heater was empty.
- When the water is flowing smoothly, close the hot tap and open the cold tap to expel any air left in the plumbing system. Close this tap when the water runs smoothly.
- The system is now ready for use.
- Repeat with all taps to expel any air in the

system.

- Remove the shower head and repeat the above actions to dispel any air from that as well.

Hints

- Should the motorhome be left unattended, or the water supply has been allowed to empty, switch off the power supply to the pump at the main panel to avoid the pump running continuously.
- Should the flow rate from the taps be reduced at any time, check the grit filter at the side of the pump, and clean as necessary.

Cleaning the Grit Filter

Switch off the power supply to the pump, and drain the water system.

- In areas of limited access to the grit filter it will need to be removed. (should you be unsure of how to complete this for your particular vehicle please contact your Bailey retailer or Whale support. Following the arrows marked OPEN on the filter cover, unscrew the filter cover.
- Remove and clean the filter.
- Replace the filter.
- With the O-ring in its groove, replace the filter cover, following the direction of the CLOSE arrows on the Filter Cover, until fully seated.
- Under no circumstances should the Whale Universal pump be run without a filter on the suction side.

Routine Maintenance

- Ensure the water fill hose O-ring and socket are kept free from dirt.

- Drain system thoroughly during the winter months.
- Service the inlet annually.
- Inspect and clean the grit filter annually. If there is any damage or wear and tear evident it should be replaced
- The system is pressure controlled to protect your motorhome from sustaining damage to its water system.
- Plumbing connections should be checked at the beginning and end of each season for frost damage or loose connections.
- When you are using the Aquasource system it is important that you do not sleep or leave the vehicle unattended without turning the water source off at the supply point.

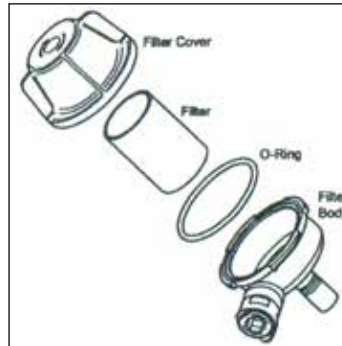

Draining and winterising the water system

Motorhomes are often used all year round, but when they are not in use, even for short periods, this procedure should be followed. One night in freezing temperatures is all that is required for expensive, permanent damage to water system components.

- Open all taps, shower controls and shower rose on/off controls, lift the ceramic ball mixer tap levers in the central position to allow both the hot and cold water to drain.
- Open the valves and run the pump to drain the system.
- Remove the shower head.
- To remove the shower head, unscrew by hand then shake out and store in a dry place.
- Open the drain valve next to the water pump.



It is essential that the lever of the ceramic ball is fully raised and in a central position. Failure to do this will not allow both the hot and the cold water system to fully drain and will therefore result in frost damage.



Frost damage cannot be claimed for under warranty.

Shower tray

Although your shower tray is fitted with two drainage points and every effort has been made to ensure that the shower tray can drain completely, some residual water may remain which will require "mopping up".

Waste water

It is important that your waste water (often referred to as grey water) from the motorhome's sinks and shower tray is disposed of in a suitable way.

Upon arrival at a site advice should be sought from the site manager as to whether there is a dedicated motorhome service area which includes a waste (grey) water drain.



Adjusting your Pressure Switch

Your pressure switch is factory set and should not normally require adjustment. However, adjustment may be required if the power supply voltage has varied from the previous setting, either due to battery drainage or higher voltage being supplied when the battery charger is operating. In the event that your pump doesn't switch off when you close the taps, or it pulses on and off rapidly when the taps are fully open, follow these guidelines to re-adjust the pressure switch setting.



In-Line Pressure Switch

Internally located within the water system pipework

Pressure Switch Setting

Ensure the system, including the heater is full of water and all taps are closed. Refer to your user manual.

Tighten the adjusting screw clockwise until the pump comes on. (For integral socket based pressure switches, first loosen the pressure switch locknut in an anti-clockwise direction.)

Open any tap until you have a smooth flow of water, then close the tap. You should hear the pump running and the pump running light if fitted will be on.

Return to the pressure switch and turn the pressure switch adjustment screw slowly anti-clockwise until the pump has stopped. Turn the screw a further half turn (180 degrees) anti-clockwise.

Check for correct operation by opening and closing all taps individually. The pump should turn on when the cold tap is opened and switch off immediately when the cold tap is closed. NB. There will normally be some pulsations at low flows.

The hot side may take about 10 seconds to react (both on and off) due to cushioning effect in the water heater.

For integral socket based pressure switches, carefully tighten carefully tighten the locknut until it is tight keeping the adjustment screw in position.

THREE GOLDEN RULES:

1. NEVER allow the pump to run dry
2. NEVER allow the pump to run continuously for more than 15 minutes
3. The pump assembly MUST be unplugged BEFORE putting the pump back into the refilled water container.

If setting of the pressure switch is still not correct you may experience:

Pump running continuously, even with tap closed. If undiscovered, could result in pump failure and flat battery. Most likely causes are that present voltage is significantly lower when last adjusted, or water container is empty.

CURE: Re-adjust switch or refill container

Pump does not run at all. If not due to blown fuse or faulty connections, then most likely cause is excessive continuous running (see above)

CURE: Replace pump and re-adjust switch

Pump runs intermittently ON, OFF, ON, OFF etc. Seen as pulsing flow from tap, or as inability to set constant water temperature, water goes hot, cold, hot, cold instead of constant warm. Most likely cause is that present voltage is significantly higher than when last adjusted.

CURE: Re-adjust pressure switch, if problem persists add a Whale Surge Damper (WS7205).

Pump runs very noisily but does not pump water. Likely to occur after water container has been refilled. Pump is air-locked and is fighting to get air out and water in.

CURE: Unplug from the socket, allowing pump to flood, and reconnect by plugging in again. The correct sequence when refilling the container is to unplug, put pump into container, then reconnect.

Pump continues to run for up to 30 seconds after tap is turned off. This is not a problem. This is a characteristic of pressure switch systems caused by the dampening effect of the hot water heater or surge damper on the cold side.

If after following these procedures the system continues to pulse when all taps are closed there may be a leak in the system.

Please contact Whale Support for further guidance.

Whale's policy is one of continuous improvement and we reserve the right to change specifications without prior notice. Whale® is a registered trademark of Munster Service Engineering Ltd (also trading as Whale). ©2012 Copyright of Munster Service Engineering (also trading as Whale) all rights reserved. Please note, these tips are included as a guide only. For servicing and product advice for your specific vehicle please contact Whale Support.



Whale Support

tel: +44 (0)28 9127 0631
fax: +44 (0)28 9146 6421
info@whalepumps.com
whalepumps.com

Whale Heater Support
0845 217 2933

Call us directly for product and installation advice



Our broad range of products include innovative water and heating system products for the recreational vehicle market.

Market Leaders in innovative water and heating system technology



Innovation
Award winning, pioneering designs



Service
First class support and advice



Quality
Every product, fully tested, every time



Water pumps Taps and Showers



Water Heating



Plumbing



Space Heating

 **Whale**[®]
2 Enterprise Road, Bangor, Co. Down,
BT19 7TA, Northern Ireland.

Tel: +44 (0)28 91270531
info@whalepumps.com
www.whalepumps.com



 Proud to manufacture in the UK

GAS SYSTEM

General information

Gas cylinders: Bottled liquefied petroleum gas (LPG) is the most convenient "portable" source of fuel for your vehicle.

Cylinders are available in the following sizes:
 Calor Gas = 3.9kg, 4.5kg, 6kg and 7kg.
 BP Gaslight = 5kg and 10kg.



The gas system meets BS EN 1949:2011 and should only be modified by a competent person.

Never use portable cooking or heating appliances, other than electric heaters that are not direct radiant type, as they are a fire and asphyxiation hazard.

Types of gas

Butane

Butane is supplied in the UK in green or blue bottles.

Continental bottles usually have a male left hand thread similar to but not identical with UK Butane.

Butane is suitable for use at temperatures down to 2°C but will not work below that temperature.

Propane

Propane is supplied in red, or partly red bottles that have a female left hand threaded connector.

Scandinavian countries use the same connector.

Germany and Austria supply propane with a male connection.

Propane will work at temperatures as low as

-40°C and is therefore suitable for all year touring.

All gas appliances in your motorhome can have their gas supply individually isolated by turning off the relevant tap. The tap is located either on the centrally positioned gas manifold or directly beside the appliance.

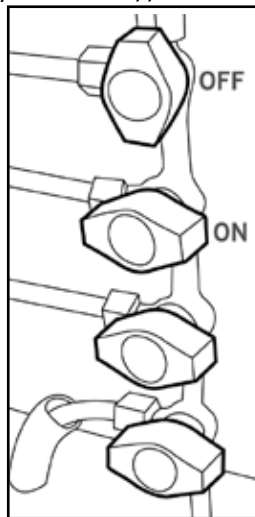

Regularly check flexible gas hoses, joints and connections for tightness.

Finally make sure that each gas appliance is working efficiently to the recommendations of the appliance manufacturers.

The Autograph range is installed with en route heating allowing you to travel safely while still using your heating system and

without switching off the gas cylinders. When travelling, ensure that your cooking appliances are switched off before you move your vehicle.

In all Advance models the gas bottle must be turned off before you move the vehicle.

Regularly check the flexible gas hose, joints and connections for tightness. Finally make sure that each gas appliance is working efficiently to the recommendations of the appliance manufacturer.

Only use gas cylinders that are mounted in their dedicated storage locker and secured using the straps provided. Never extend the hose; it must not exceed 450mm.

If you decide to use gas cylinders of another size it is very important that you ensure the cylinders are adequately supported and they do not block the ventilation in the openings in the gas locker compartment. Ensure that these gas cylinders do not cause damage to the fixtures and fittings located in the gas cylinder compartment.

Regulator

The regulator is a governing device which adapts the bottle pressure to one that suits the equipment in the caravan.

Your motorhome is fitted with a regulator as standard equipment. This is located in the motorhome gas box mounted on the bulkhead of the motorhome between the gas bottles. The gas regulator has a working pressure of 30mbar and is suitable for both propane and

CONNECTION OF SERVICES - The Gas System

butane liquefied petroleum gas. There are dedicated hoses available for different types of gas/bottle. They are also available for camping gas and other mainland Europe LPG suppliers. Please contact your retailer who will have a stock of these hoses.

The gas pressure regulation system provides an even output pressure of 30mbar.

The regulator is a governing device that adapts the pressure from the gas cylinder to one that suits the equipment within the motorhome.



Do not use a regulator with a different operating pressure.

The Autograph Range

Your Bailey Autograph motorhome is fitted with a wall mounted Truma MonoControl CS safety gas pressure regulator plumbed inside the gas cylinder compartment.

A high pressure gas hose with integrated hose rupture protection (HRP) is essential for connecting the gas cylinder to the gas pressure regulation system. The integrated crash sensor complies with the Heating Equipment Directive 2001-56-EC with the supplements 2004-78-EC and 2006/119/EC. The crash sensor enables you to use a liquid gas heater while driving while providing suitable precautions against an uncontrolled release due to an accidental disconnection. The gas system is certified for use throughout Europe while the vehicle is being driven. It is important that all gas appliances are turned off when at a fuel station.

In the event of an accident with deceleration

of 3.5g with a tolerance of 0.5g acting directly upon the triggering element, the integrated crash sensor interrupts the flow of gas.

Gas Hoses

A high pressure hose with hose rupture protection (HRP) is essential for connecting the gas cylinder to the gas pressure regulation system. Truma provides the necessary high pressure hoses with the most commonly used connection variants for European gas cylinders.



The pressure regulating devices and hoses must be replaced with new ones no more than 5 years after their date of manufacture (every eight years if used commercially). This is the responsibility of the operator.

All gas cylinders have unique connections. It is important to check that you have the correct hose and/or adaptor to suit your gas cylinder. Push-on hoses are no longer permitted under the latest regulations.

Gas cylinders that are not connected to the gas installation must be closed off at all times and provided with protective caps.

It is important that only upright gas cylinders are used when operating the MonoControl CS gas pressure regulation system. Gas cylinders from which gas is extracted in the liquid phase must not be used, since they would result in damage to the gas system.

Precautions

Make sure that cooking appliances are switched off before you move the motorhome. All gas appliances in your motorhome can have their gas supply individually isolated by turning off the relevant tap. The tap is located either on the centrally positioned gas manifold or directly beside the appliance.



Some industrial LPG appliances operate at high pressure and require a "high pressure" regulator. This often has an adjusting handle on it. Never use such a regulator on a motorhome.

- Always ensure that the gas system is inspected/maintained at least every 12 months.
- In the event of a fire ensure all occupants evacuate the motorhome via the nearest escape route.
- If you suspect a gas leak then immediately turn off the supply of gas at the yellow isolation tap located below the regulator in the gas box. Then turn off the gas valve on the gas cylinders. When this has been completed the system must be inspected by a competent person.
- Never use gas cylinders located outside the motorhome gas box. Do not use any gas extension hoses.
- Never replace your regulator with one that does not conform to EN12864 Annex D as this does not comply with EN1949.

Operating Instructions

Start Up

- Open cylinder valve (no 1).

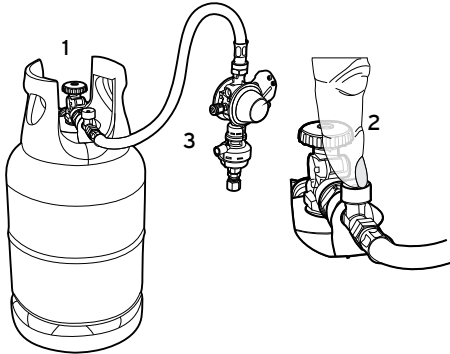

- Firmly press the hose rupture protection (green button no. 2) on the high pressure hose.
- If necessary (e.g. after a new installation or after inadvertently striking the gas cylinder against the gas pressure regulation system), hold the reset button (no. 3) in for at least 5 seconds before slowly releasing the green button (crash sensor triggering element reset) on the MonoControl CS.

 Some cylinder valves differ including products fitted with push-on connectors or something similar.

Changing the LPG Cylinder

Please use the included spanner to attach and remove the high pressure hose from the cylinder. It will help to generate the necessary tightening torque and will prevent damage to the screw fixings by over-tightening.



Residual gas: do not smoke, avoid open flames.

- Close the empty gas cylinder's valve.
- Remove the high pressure hose from the gas cylinder.
- Attach the high pressure hose to the full gas cylinder.
- Open the full cylinder's valve.
- Press the hose rupture protection.

At any time after making changes, check the hose connection to the cylinder valve for leaks using a leak detector spray or a soapy solution.

Hose Change

Residual gas: do not smoke, avoid open flames.

- Close gas cylinder valve.
- Remove the high pressure hose from the gas cylinder and from the regulator inlet.



When performing a hose change please ensure that the O-ring provided with the hose is correctly installed and not damaged.

- Screw country-specific high pressure hose to MonoControl CS inlet and to the cylinder.
- Open gas cylinder.
- Press the hose rupture protection and, if

necessary, the reset button.

- Check hose connection to cylinder valve and at MonoControl CS inlet for leaks after every modification.



We recommend that the gasket (part number 50020-76300) is replaced with every hose change. This will be provided by your supplying dealer upon replacement of the hose.

Gas Leaks

If a smell of gas becomes apparent, the supply should be turned off at the cylinder immediately. Extinguish naked lights including cigarettes and pipes. Do not operate electrical switches. Open all doors and windows to disperse any gas escape. Butane/propane gas is heavier than air; any escaping gas will therefore collect at a low level. The strong unpleasant smell of gas will enable the general area of the leak to be detected. Check that the gas is not escaping from an unlit appliance. Never check for leaks with a naked flame; leak investigation should be carried out using a leak detector spray or soapy solution.

Do not operate any electrical apparatus whatsoever, especially light switches. If the leak is not obvious, the motorhome should be evacuated and a competent service engineer consulted. Avoid naked lights when connecting or changing a cylinder. Ensure the gas valve is turned off. Regularly inspect the flexible gas hoses for deterioration and renew as necessary with approved type (all hoses should be replaced every five years).

Keep gas cylinders outside (and protected against frost). If they must be kept inside make

CONNECTION OF SERVICES - The Gas System

sure they are well away from heat and near to a drop out vent.



Additional independent gas appliances should not be used inside the motorhome.

Ventilation

Carbon monoxide is odourless, colourless and tasteless and will rapidly cause unconsciousness and death with little or no warning prior to collapse.

Under no circumstances should the motorhome's ventilation be blocked or obstructed in any way.

High level ventilation is via the rooflights. The low level ventilation is via the vents in the floor at the front of the motorhome living area directly behind the front bulkhead. With multi berth layouts the rear sleeping compartments have their own low level ventilation. Please consult your motorhome retailer for its location.

The mesh screens and the open end of the gas hose should be kept free of obstructions by dust, leaves, etc. Inspect regularly and use a brush and soapy water as necessary. It may be necessary to remove the weather shield located on the underside of the floor of the motorhome to gain access for cleaning.



Safety ventilation shall in no circumstances be obstructed, even partially.

General Safety Notes

In the event of leaks in the gas systems or if there is a smell of gas:

Extinguish all naked flames.

- Do not smoke.
- Switch off appliance and gas cylinder.
- Open the windows.
- Do not operate any electrical switches.
- Have the entire system checked by an expert.

Repair jobs are only to be carried out by an expert.

The following would invalidate the guarantee:

- Any alteration to the appliance (including cowl)
- The use of non-Alde spare parts/accessories
- Non observance of the operating instructions.

The operating pressure for the gas supply is 30mbar (or 28mbar butane/ 37mbar propane) and must correspond to the operating pressure of the appliance (see name plate).

Do not operate the water heater when refuelling the vehicle and when in the fuel station.

During initial operation of a brand new appliance (or after it has not been used for some time), a certain amount of fumes and a slight smell may be noticed for a short time. Remedial action here is to immediately run the heater at maximum output and to ensure adequate room ventilation.

If the burner makes an unusual noise or if the flame lifts off, it is likely that the regulator is faulty and it is essential to have it checked.

ELECTRIC SYSTEM
THE ELECTRICAL SYSTEM - 230 VOLT

As in the home, care must be exercised when handling mains electricity. Your attention is drawn to the following notice as laid down by the Institute of Electrical Engineers. Instructions for electricity supply - low voltage (230V)

On arrival at motorhome site.

Before connecting the motorhome installation to the mains supply:

- Check that the mains supply is suitable for your installation and appliances, i.e. whether it is AC or DC and whether it is at the correct voltage, frequency and polarity.
- Check that your installations will be properly earthed. Never accept a supply from a socket outlet or plug having only two pins, or from a lighting outlet.
- Check that any residual current device (RCD: earth leakage circuit breaker) in the mains supply to the motorhome has been tested within the last month. After connection to site supply, test again.
- Make sure that the switch at the site supply point is off.
- Make sure that the motorhome RCD unit is switched off.
- Remove any cover from the electricity inlet provided on the motorhome, and insert the connector of the supply flexible cable.
- Remove any cover from the socket outlet provided at the site and connect the plug at the other end of the supply flexible cable to this. Switch on the main switch at the site supply point. (If there is no switch the power will already be live.)

- Leave spare cable in loose coils on the floor and not on a drum.
- Switch on the motorhome RCD unit.
- It is at this point it is good to check the trip switch. Reposition it to see if this activates the flow.
- In case of doubt, consult the site owner or their agent.

On leaving motorhome site

- Switch off the site supply.
- Switch off the motorhome RCD unit.
- Then disconnect the pitch lead.
- Switch off and disconnect portable appliances.
- Stow cable in a tidy state.
- In case of difficulty consult an approved electrical installation contractor (who may be the local electricity board). It is dangerous to attempt modifications and additions yourself.
- Lamp-holder plugs (bayonet-cap adapters) should not in any circumstances be used.
- Replace the cover of the socket outlet at the site supply point. It is dangerous to leave the supply socket or supply flexible cable live.
- Every 12 months, the motorhome electrical installation should be inspected and tested and a report on its condition obtained as prescribed in the Regulations for Electrical Installations, published by the Institute of Electrical Engineers.

Generators

- Switch off all appliances, the miniature circuit breakers and the residual current device.

- Start the generator and allow to run for a few minutes to stabilise.
- Connect the motorhome to the generator using an approved hook-up cable.
- Switch on 16 amp miniature circuit breaker.
- Switch on the residual current device.
- Switch on the fridge (230V phase) or plug in a 230V light to one of the 13amp sockets. This is to provide a load on the generator and help remove any "spikes" in the supply which can damage the charger unit.
- Switch on the 5amp miniature circuit breaker and any other appliances you require.

It is always advisable to have at least one other mains appliance switched on with the charger unit to minimise the chance of damage to it.

Do not connect the 12V output of the generator to the battery terminals. The AC ripple must not exceed 10%.

Overseas connections

Connection to a mains voltage supply overseas requires particular attention. Care must be taken when connecting supplies abroad since the supplies can have reverse polarity. The significance of reverse polarity is that when equipment is switched off it may not be electrically isolated.

The only certain way of making equipment safe is to unplug it.

Motorhome Service Systems

A means of checking the polarity of the mains

CONNECTION OF SERVICES - The Electric System

supply when overseas is useful.

There are available several proprietary makes of equipment for the purpose (e.g. Martindale tester unit).

Check all motorhome equipment is set up to accept the site supply before actually switching on.

Mains unit

The mains unit replaces the conventional fuse box. Similar, but larger units are often fitted in modern houses. The unit gives overload and earth leakage protection for the 230V electrical supply in your motorhome.

For normal operation all switches on the unit need to be in the ON position. The switches on the left of the unit are known as MCB's (miniature circuit breakers).

In the event of a fault the MCB "trips", i.e. automatically moves to the OFF position.

After elimination of the fault the MCB. can be reset by switching to the ON position (against the spring pressure in an upwards direction).

If an earth fault develops or a person were to touch a live piece of equipment, the leakage of current to earth should immediately operate the RCD (residual current device) and "trip" the main switch, to its OFF position.

This switch is only resettable after elimination of the fault.

To reset, operate the switch as for MCBs.

Every time you connect to a site supply the RCD should be checked by operating the test button marked "T". The unit should immediately switch to the OFF position. If the unit does not switch off, do NOT use the mains supply system and a qualified electrician should be called.

If the unit does switch off, the test is complete and the switch can be reset restoring the supply back to normal.

Having too many appliances switched on at the same time will trip the MCB. This is a safety measure.

It is essential that connections are made exactly as shown. If terminal markings are not in accordance with the diagram they must be ignored. If in doubt consult a qualified electrician.

It is possible that all of the 230V mains electrical equipment may not be able to be operated simultaneously.

Many motorhome park mains hook-up points provide a maximum output of 16 amps and on some continental sites the available output may be as low as 5 amps. If your loading exceeds the site supply it may trip the park's circuit breaker. Please check the available mains output in amps with your site operator.



No appliance shall be used outside when being connected to the internal socket.

THE ELECTRICAL SYSTEM - 12 VOLT

Your motorhome is fitted with a dual stage power supply/charger supplying 14.2V to your leisure battery and between 13.6/13.8V to the habitation unit. This converts the 230V AC supply to 12V DC. This enables the 12V equipment in the motorhome to function and charges the motorhome leisure battery. A fully charged leisure battery should read 12.7V on the voltmeter mounted in the control panel. During charging the control panel will temporarily read between 14.2/13.8V.

The charger is capable of charging leisure batteries and will not overcharge. The 12V system is designed to operate with a leisure battery in circuit and should not be turned on without one connected. The 12V supply to the Motorhome services can be isolated via the 12V on/off switch on the control panel.

The 12V electrical systems fuses are located either in a bed box or under the fixed bed. It has 14 fuses, each having identification to their particular use. If a fuse is to be replaced it must be with one of the same rating as the one that is removed.

For more information on the power supply please refer to the specification page in your service manual.

Auxiliary battery storage/mains inlet

The battery is located under the floor in the motorhome in a sealed compartment. The Autograph compartment will accommodate two batteries up to 110 amperes/hours capacity. The Advance compartment accommodates one battery of up to 110 amperes/hours capacity. The battery must be placed in the tray provided in the battery storage compartment, and this

must be used at all times.

A battery of not less than 60 amperes/hours capacity is recommended. Crocodile clips should never be used to connect the battery, and terminals should be shrouded.

The 230V mains inlet is located on the side of the motorhome.



Always switch off all appliances and lamps before disconnecting the auxiliary battery.

- The battery should be secured to prevent movement when in transit.
- Metal objects should not be stored in the battery box.
- DIY modifications/additions to the wiring systems are not recommended. Consult your dealer who will be pleased to carry out such work.
- Switch off all appliances before disconnecting battery.
- Negative connections should always be disconnected first and reconnected last.
- Car type battery chargers are not suitable for charging a leisure battery and may damage it.
- When not using motorhome models always ensure that the fridge control knob is turned to the "off" position. Failure to do this will result in a flat battery due to 12V power drain from the fridge circuit relays.

Banner Leisure Battery

Bailey has chosen to fit a Banner Energy Bull 100ah semi - traction leisure battery to the APPROACH AUTOGRAPH models and a Banner Energy Bull 80ah to the APPROACH ADVANCE models. The part Numbers are 95751 for the 100ah & 95601 for the 80ah. These batteries are designed to cope with today's increased energy demands and both are thick plate glass matt, separated out and out leisure battery. By choosing Banner we are assured of a first-class product fit for purpose, supplied by a leading European battery manufacturer with an excellent After market pedigree and certified manufacturing and distribution processes. Banner possesses the latest ISO9001, ISO/TS 1649 and ISO 14001 quality certification.



- Wear goggles when working with the battery.
- Keep out of reach of children.
- Keep away from naked flames.
- Dispose of old batteries at an authorised collection point. For a replacement unit please contact:
 - Bailey-Parts.co.uk
 - The battery must always be kept upright without any danger of tipping. However, your Banner battery has 4 chamber leak protection so should not leak during normal handling.
 - Prior to removal of the battery switch off all electrical systems.
 - When removing the battery always remove the negative terminal first.
 - Always ensure that the battery's tray is clean.
 - Never use a frozen battery or a

CONNECTION OF SERVICES - The Electric System

battery in a temperature above 45° or warm to the touch.

- Stop using the battery if it becomes hot or acid escapes.

Your Banner battery is 100% maintenance-free, which means under normal circumstances no maintenance is necessary.

However, if there is a problem with the charging system you will be able to check the acid levels through the case; if they have dropped below the height of the plates, you can add distilled water.

Never overcharge your battery; a maximum voltage of 14.7V boost & 13.8V float should be used.



The deeper the discharge the more wear is placed on the battery, so less cycling means longer life.

Taking out of operation

- Store in a cool dry place. Never store a flat or discharged battery. Always charge before storage and monitor voltage.
- Check the battery voltage every 4 months and recharge with a suitable battery charger if it has fallen below 12.5V.
- If the battery is left in the vehicle during storage, disconnect the negative terminal.
- For long periods of storage or non-use connect the battery to a suitable long term connection charger with a float mode such as an Optimat 5 or 6.

Banner

ENERGY BULL POWERS



Bailey have partnered with Banner Batteries
From 2013 all vehicles are supplied with an
O.E. quality premium TRUE LEISURE BATTERY.

- True capacity ratings - 95751 100ah @ 20hr & 110ah @ 100hr (Autograph models)
- True capacity ratings - 95601 80ah @ 20hr & 90ah @ 100hr (Advance models)
- True semi traction technology
- True spill proof
- True backfire protection
- True cyclic ability
- True original equipment supplier
- True quality
- True warranty replacement service



TEL : 01179 538140 or e-mail: parts@baileyofbristol.co.uk



THE AUTOGRAPH CONTROL PANEL

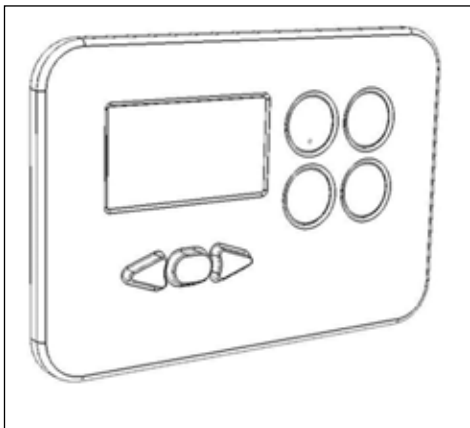

Overview

The control panel provides the user with a central point to check:

- Leisure battery voltage
- Vehicle battery voltage
- Level in fresh water tank
- Level in waste water tank
- Current in amps being drawn from the leisure battery
- Inside (internal) temperature
- Outside (external) temperature
- Time

The control panel also provides the user with the ability to:

- Switch off all non-essential electrical appliances/accessories
- Switch off all the lights
- Switch off the pumps
- Switch the awning light

- Charge the vehicle battery when 230V mains is connected
- Force internal pump to run (for purging pipes)

The control panel has optional audio and visual warnings for:

- Low battery (leisure)
- Low battery (vehicle)
- Low level (fresh water tank)
- High level (waste water tank)
- High power drain (leisure battery)
- 230V mains supply lost
- Circular function buttons

Master Switch

 When pressed will switch power to all non-essential accessories.

The alarm, radio and fridge still receive power when the master switch is off.

Lights Switch

 When pressed will switch power to all the interior lights.

If the master switch is off, this button will not function.

Pump Switch

Also see "Icons" section below for relevant warning icon.

 When pressed will enable/disable the water pumps. Holding this button will force the internal pump to run.

If the master switch is off, this button will not function.



FITTED EQUIPMENT - The Control Panel

Awning Switch

 When pressed will switch power to the awning light.

If the master switch is off, this button will not function.

Navigation buttons   

Use  and  buttons to navigate.







Press  to enter function or change settings (if further settings are available).

Screens

Time

The time screen is displayed by default. The control panel will return to the time screen when left idle.

Setting the time:

1. On the time screen, hold  for 3 seconds until the hours begin to flash.
2. Keep pressing  or  to change hours.
3. Press  to set hours; minutes will now flash.
4. Keep pressing  or  to change minutes.
5. Press  to finish.

Water Level

Also see "User Settings" (on the next page) -> "Water Low" for associated alarm.

Also see "Icons" section for associated icon.

 The level in the fresh water tank is displayed as a % on this screen.

FITTED EQUIPMENT - The Control Panel



Waste Level

Also see "User Settings" -> "Waste High" for associated alarm.

Also see "Icons" section for associated icon.

 The level in the waste water tank is displayed as a % on this screen.



Fill Internal Tank?

 With the external pump connected to the inlet and to an external water source, press  to fill the internal tank.

Note: When the internal tank is full the pump will stop automatically.



External Temperature

 The outside temperature, as detected by a sensor underneath the van, is displayed on this screen.

You can change between degrees Celsius and degrees Fahrenheit by pressing  and selecting  for °C or  for °F.

Internal Temperature

 The inside temperature, as detected by a sensor inside the control panel, is displayed on this screen.

You can change between degrees Celsius and degrees Fahrenheit by pressing  and selecting  for °C or  for °F.

Select Battery

Also see "Icons" section for associated icon.

 With 230V mains disconnected, the user can choose to draw power from the leisure battery OR the vehicle

battery.

Press  to swap between batteries.

If the "Auto-Battery" feature is enabled (see "User Settings" section) the system will automatically switch to "Vehicle Battery" if the "Leisure Battery Voltage" is low (less than 11V).



Note: When 230V mains is connected "Leisure Battery" is automatically selected and cannot be changed.

Leisure Battery Amps

Also see "User Settings" -> "Amps High" for associated alarm.

Also see "Icons" section for associated icon

 The current being drawn from your leisure battery, in amps, is displayed on this screen. A higher current will drain your battery faster.

To display current draw as a % of maximum recommended current press  then .

Note: (OA = 0%) (12A = 100%)* /

You can return to displaying in Amps by pressing  then .



Leisure Battery Voltage and Vehicle Battery Voltage

Also see "User Settings" -> "Low Volts V" for associated alarm.



Also see "User Settings" -> "Low Volts L" for associated alarm.

Also see "Icons" section for associated icons.

 With 230V mains disconnected, this screen shows the voltage of the currently selected battery (set on "Select Battery" screen).

An estimate of your batteries' remaining charge can be seen by pressing  then .

Note: (12V = 0%) (12.7V = 100%).



You can return to displaying in volts by pressing  then .

*Note: To increase accuracy of the voltage reading, switch the "Master Switch" off.







Note: The "Leisure Battery Voltage" actually displays the voltage of the charger while 230V mains is connected.

*Note: "Vehicle Battery Voltage" cannot be displayed while 230V mains is connected.

User Settings

 Press  to access the "User Settings" screen. See below for a description of each option.

Navigation

- You can scroll through the settings with the  and  buttons.
- To edit a setting, highlight it by pressing .
- When it is highlighted press  or  to change value.
- Press  to accept new value.

- To exit, scroll to "Exit to main menu" and press .

Contrast (of LCD screen)

Press then to decrease, to increase. Press to finish.

Beep (Disables sounder)

Press then or to set "on" or "off". Press to finish.

Water Low (Warning tone and pop up with water tank low level)

Press then or to set "on" or "off". Press to finish.

- When level is low the alarm sounds and a pop up appears. Press to cancel. Only rearms when level is increased by at least 25%.

Waste High (Warning tone and pop up with waste tank high level)

Press then or to set "on" or "off". Press to finish.

- When level is high the alarm sounds and a pop up appears. Press to cancel.
- Only rearms when level is reduced below 50%.

230V Lost (Warning tone and pop up when 230V mains is lost)

Press then or to set "on" or "off". Press to finish.

- When mains voltage is lost, alarm sounds and a pop up appears. Press to cancel.

Only rearms after 230V mains has been restored.

Amps High (Warning tone and pop up when current draw is high)

Press then or to set "on" or "off". Press to finish.

- When current drawn from leisure battery is high (12A), alarm sounds and a pop up appears.
- Press to cancel.
- Only rearms when current is reduced below 5A.

Low Volts V (Warning tone and pop up when vehicle battery is low)

Press then or to set "on" or "off". Press to finish.

- When voltage in vehicle battery is low (less than 11V), alarm sounds and a pop up appears.
- Press to cancel.
- Only rearms when vehicle voltage is greater than 13V.

Low Volts L (Warning tone and pop up when leisure battery is low)

Press then or to set "on" or "off". Press to finish.

- When voltage in Leisure battery is low (less than 11V), alarm sounds and a pop up appears.

FITTED EQUIPMENT - The Control Panel

- Press to cancel.
- Only rearms if leisure voltage is greater than 13V.

Charge VBatt (Displays option to charge vehicle battery when 230V mains is connected)

Press then or to set "on" or "off". Press to finish.

Standby (Set how long the backlight stays on after the last button is pressed)

Press then to decrease, to increase. Press to finish.

Auto Battery (When the leisure battery is low, automatically swap over to the vehicle battery)

Press then or to set "on" or "off". Press to finish.

FITTED EQUIPMENT - The Control Panel

Icons

There are a number of icons that can appear at the top of the time screen.

See below for a description of each icon.

Icon	Description
	Internal Pump is running
	Leisure battery is below 12.2V
	Over 12A of current is being drawn from the leisure battery
	The fresh water tank level is below 10%
	The waste water tank is over 75% full
	The living space is being powered by the vehicle's battery rather than the leisure battery
	The 230V mains is connected

Warranty

If you believe there is a problem with your control panel please contact your dealer who will be able to help.

THE ADVANCE CONTROL PANEL



User Manual

Overview

The control panel provides the user with a central point to check:

- Leisure battery voltage.
- Vehicle battery voltage.
- Level in fresh water tank.
- Level in waste water tank.
- Current in amps being drawn from the leisure battery.
- Inside (internal) temperature.
- Outside (external) temperature.
- Clock

The control panel also provides the user with the ability to:

- Switch off all non-essential electrical appliances/accessories.
- Switch off all the lights.
- Switch off the pumps.
- Switch the awning light.
- Charge the vehicle battery when 230V mains is connected.
- Force internal pump to run (For purging

pipes).

- Control Whale Space Heater.
- Control Whale Water Heater.

The control panel has optional audio and visual warnings for:

- Low battery (leisure).
- Low battery (vehicle).
- Low level (fresh water tank).
- High level (waste water tank).
- High power drain (leisure battery).
- 230V mains supply lost.
- Function buttons.

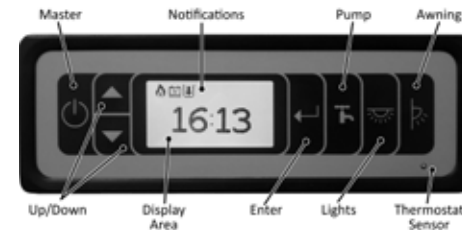

Master Switch

When pressed will switch power to all non-essential accessories.

Holding down the master switch will cause the control panel to shut down completely. The time will be lost and have to be reset when restarted. The control panel can also be shut down from user settings.

Note: The alarm, radio and fridge still receive power when the master switch is off.

Lights Switch

When pressed will switch power to all the

interior lights.

Note: If the master switch is off, this button will not function.

Pump Switch

When pressed will enable/disable the water pumps. Holding this button will force the internal pump to run.

Note: If the master switch is off, this button will not function.



Note: See "Notifications and Warnings" section for pump running notification.

Awning Switch

When pressed will switch power to the awning light.

Note: If the master switch is off, this button will not function.

Navigation Buttons

Use  and  buttons to navigate up and down through menus.



Press  to enter function or change settings (if further settings are available).





Menus

Home





The home screen is displayed by default. The control panel will return to the home screen when left idle. The home screen displays the time as well as any relevant notifications or warnings that are present.







Setting the time:

1. On the home screen, hold  for 3 seconds until the hours begin to flash.
2. Keep pressing  or  to change hours.



3. Press  to set hours, minutes will now flash.
4. Keep pressing  or  to change minutes.
5. Press  to finish.



Whale Space Heater





This control panel has been designed to integrate Whale appliances into a single control panel. To turn the heater off/on press . The screen will display either the word off or the thermostat setting. To change the heating mode press and hold  and the mode icon will begin to flash. Press  or  to change the mode between the following options:

Icon	Mode	Description
	2000W	Heat boost electric setting
	1000W	Intermediate heat electric setting
	500W	Quiet/ night time electric setting
	Off	Heater off position
	Fan Only	Air circulation setting, no heat output
 or 	Gas	Gas only setting

FITTED EQUIPMENT - The Control Panel





 Or 	Heat Boost Setting	Uses gas and electric simultaneously for higher heat outputs.
---	--------------------	---





On all gas settings a filled flame  represents that the gas is currently burning. An empty flame  shows that gas is selected but not burning. A flame icon  on the homepage will also indicate that a gas appliance is currently in use.

Once the intended mode is selected press  to set the mode and move on to thermostat temperature selection. Select the desired room temperature with the  and  buttons and press  to save.

Note: Please consult the Whale user manual for more detailed information on each mode.

Whale Water Heater

To turn the heater off/on press . The screen will display either the word off or the thermostat setting. To change the heating mode press and hold  and the mode icon will begin to flash. Press  or  to change the mode between the following options:

This control panel has been designed to integrate Whale appliances into a single control panel. To turn the boiler off/on press . The screen will display either the word off when the boiler is off. To change boiler mode press and hold  and the mode icon will begin to flash. Press  or  to change the mode between the following options:

Icon	Mode	Description
	Electric high only	To operate the heater on electric high setting only
	Electric low only	To operate the heater on electric low setting only
	Heater off	To turn the heater off completely
	Gas function	To operate the heater on gas only
	Gas and electric low	To operate on gas and electric low
	Gas and electric high	To operate on gas and electric high

Press to set the heater mode. On all gas settings a filled flame represents that the gas is currently burning. An empty flame shows that gas is selected but not burning. A flame icon on the homepage will also indicate that a gas appliance is currently in use.

Note: Please consult the Whale user manual for more detailed information on each mode.

Water Level

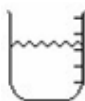

The level in the fresh water tank is displayed as a % on this screen.
Note: See "Notifications and Warnings" section for water low

warning and "User Settings" section for water low alarm enable.

Waste Level



The level in the waste water tank is displayed as a % on this screen.

Note: See "Notifications and Warnings" section for waste high warning and "User Settings" section for waste high alarm enable.

Fill Internal Tank?



With the external pump connected to the inlet and to an external water source, press to fill the internal tank.

Note: When the internal tank is full the pump will stop automatically.

External Temperature



The outside temperature, as detected by a sensor underneath the van, is displayed on this screen.

You can change between degrees Celsius and degrees Fahrenheit by pressing and selecting for °C or for °F.

Internal Temperature



The inside temperature, is detected by a sensor inside the control panel, is displayed on this screen.

You can change between °C and degrees °F by pressing

and selecting for °C or for °F.

Select Battery



With 230V mains disconnected, the user can choose to draw power from the leisure battery OR the vehicle battery.

Press to swap between batteries.

If the "Auto-Battery" feature is enabled (see "User Settings" section) the system will automatically switch to "Vehicle Battery" if the "Leisure Battery Voltage" is low (less than 11V).

When 230V mains is connected "Leisure Battery" is automatically selected and cannot be changed.

Note: See "Notifications and Warnings" section for vehicle battery notification.

Leisure Battery Amps



The current being drawn from your leisure battery, in Amps, is displayed on this screen. A higher current will drain your battery faster.

To display current draw as a percentage press then . 12A reads 100%. You can return to displaying in Amps by pressing then .

Note: See "Notifications and Warnings" section for High current warning and "User Settings" section for amps high alarm enable.

Leisure & Vehicle Battery Voltage



This screen shows the voltage of the currently selected battery as set on the "Select Battery" screen. If a 230V mains supply is connected then the charging voltage of the Leisure battery will be displayed.

An estimate of your batteries' remaining charge can be seen by pressing then . 12V or less reads 0%, and 12.7V or more reads 100%. You can return to displaying the voltage by pressing then .

To increase accuracy of the battery voltage reading, switch the "Master Switch" off.

Note: See "Notifications and Warnings" section for low voltage warnings and the "User Settings" section the Low Volts alarm enable.

User Settings



Press to access the "User Settings" screen.

See below for a description of each option.

Navigation

1. You can scroll through the settings with the and buttons.
2. To edit a setting, highlight it then press to change.
3. If there are several options you may need to use the and buttons to change value.
4. Press to accept new value.
5. To exit, scroll to "Exit to main menu" and press .

Settings

Contrast

Adjusts the contrast of the LCD display if you are finding it difficult to read.

Sound

Enables or disables the sound when a button is pressed

Chg V Batt

When enabled the vehicle battery will be charged while 230V mains is connected. The leisure battery will also be charged at the same time.

Standby

Sets how long the control panel waits for a button press before going into standby.

Water Low

Enables or disables the warning alarm when the water tank is low.

Press to acknowledge an alarm that has triggered.

The warning will only re-arm when the water level increases by 25%.

Waste High

Enables or disables the warning alarm when the waste tank is high.

Press to acknowledge an alarm that has triggered.

The warning will only re-arm when the waste level is reduced to 50%.

230V Lost

Enables or disables the warning alarm when

FITTED EQUIPMENT - The Control Panel

the 230V mains connection is lost.

Press to acknowledge an alarm that has triggered.

The warning will only re-arm when the 230V connection is restored.

Amps High

Enables or disables the warning alarm when the current drawn from the leisure battery exceeds 12A.

Press to acknowledge an alarm that has triggered.

The warning will only re-arm when the current is reduced below 5A.

Veh Batt Low

Enables or disables the warning alarm when the vehicle battery voltage is less than 11V.

Press to acknowledge an alarm that has triggered.

The warning will only re-arm when the vehicle battery is charged over 13V.

Leis Batt Low

Enables or disables the warning alarm when the leisure battery voltage is less than 11V.

Press to acknowledge an alarm that has triggered.

The warning will only re-arm when the leisure battery is charged over 13V.

Auto Battery

When enabled the power source will switch to vehicle battery automatically if the leisure battery is low. When a charging voltage is detected, the power source will switch back to leisure battery.

FITTED EQUIPMENT - The Control Panel

Shut down now

Pressing enter here will shut the control panel down into its low power mode. The master switch will be turned off and the clock will lose its time. Pressing any button will turn the panel back on.

Firmware

Displays the current firmware version installed on the control panel.









Exit to Main Menu

Saves any changes to the settings and navigates back to the main menu.

Notifications and Warnings

There are a number of icons that can appear at the top of the home screen.

See below for a description of each icon.

Icon	Description
	Internal pump is running
	The leisure battery voltage is below 12.2V
	Over 12A of current is being drawn from the Leisure battery
	The water tank level is below 10%
	The waste tank is over 75% full
	The living space is being powered by your vehicles' battery rather than the leisure battery.
	The 230V mains is connected
	A connected gas appliance is using the gas supply.

When a new warning is triggered it may be accompanied by a pop up alarm screen if the appropriate user setting is enabled. When this happens the control panel will flash and beep until the warning is acknowledged by pressing .

Warranty

If you believe there is a problem with your control panel please contact your retailer who will be able to help.

ALDE HEATING SYSTEM

The Alde System is fitted in all Autograph models.



Always replace the heat transfer fluid (HTF) in accordance with the antifreeze product's lifespan. If in any doubt, replace the HTF after 2 years.

The corrosion inhibitors found in ethylene glycol antifreeze may not be cross-compatible. When topping up or replacing the HTF, ensure the new antifreeze is compatible with the current antifreeze product. Read the product label or contact the product manufacturer for details.

Operating Instructions: 3020 Compact High Efficiency Boiler

Alde can accept no liability whatsoever for damage or injury resulting from failure to observe these instructions.

Specified Use

These instructions are approved for the Alde 3020 Compact HE boiler fitted in caravans, motorhomes or buildings in accordance with CE 0402 no. SC0653-13, and have the E5 mark for installation in vehicles in accordance with ECE R122, no. 00 001 and R10, no. 04 166, for use in central heating and hot water systems. The boiler is not intended for use by persons (including children) with reduced physical, sensory or mental capabilities, or lack of experience and/or knowledge, unless they have been given instruction or are supervised. The term "specified use" also covers

observance of the operating and installation instructions.

The Alde 3020 Compact HE boiler must be installed or repaired by a competent person in accordance with current local regulations.

In the unlikely event that your boiler develops a fault, switch off the boiler and contact Alde, or your dealer or installer.

Operating and installation instructions for the Alde control panel are supplied separately.

The owner is always responsible for maintenance and arranging inspection.

Boiler Design

The boiler's internal heat exchanger consists of three concentric cylinders: the combustion chamber, the central heating cylinder and the hot water cylinder.

The combustion chamber is made from aluminium, and is divided into two halves by a baffle plate, with the burner head located in the top half, and the flue gases venting through the bottom half.

The combustion assembly is fixed to the end of the internal heat exchanger. It consists of the burner, combustion fan, gas valve, air intake and exhaust ducts, and gas line.

Two electric heating elements are sealed inside the central heating cylinder, one for 1kW, one for 2kW.

Description of Functions
Gas Heating

When gas heating is set to "On" the combustion fan starts to revolve. Once the correct speed is achieved (in rpm), a signal is sent to the PCB (Printed Circuit Board) for the burner to be lit. The gas valve opens, passing gas, and the

ignition module on the PCB generates sparks at the electrode on the burner head.

When the burner ignites, a flame supervision device (FSD) signals the ignition module to cease sparking. The burner fires until the boiler or room thermostat reach the set-point. Should the burner flame out unexpectedly, the FSD detects this and attempts to reignite (for about 10 seconds), before shutting down and raising a fault code.



Listen carefully to the ignition sequence of the boiler. You should hear the whirl of the combustion fan, the clunk of the gas valve and the tick-tick of the ignition module.

Electric Heating

When electric heating is set to 1, 2 or 3kW, relays on the PCB trip, feeding the 230 v supply to the electric heating elements. These are controlled by the same programme as the gas heating.

Domestic Hot Water

The combi-type boiler automatically produces hot water. Heat is emitted from the central heating cylinder into the hot water cylinder. If the hot water cylinder is empty, the air is heated but no damage can result.



In a good summer, for example, lower the desired temperature on the control panel to around 10°C. The central heating will not circulate (unless the temperature drops to 10°C), but you will still have hot water

FITTED EQUIPMENT- The Alde Heating System



The boiler must not be switched on if there is no heat transfer fluid (HTF) in the system.

- Always drain down the freshwater system if there is risk of frost; in winter, for example. You may continue to use the boiler with no freshwater in the system, as required; no damage can result.
- Always replace the HTF in accordance with the antifreeze product's lifespan. . If in any doubt, replace the HTF after 2 years.
- Only sterilise the freshwater system with a product suitable for stainless steel.
- Do not place stowage in the boiler compartment.
- Do not position awnings, tents or other enclosures around the flue terminal.
- Do not obstruct the flue. Be careful not to flood the flue when washing the vehicle.
- The gas heating must not be used when refuelling the vehicle at the service station or related facility.

Being a combi-type boiler, the Alde 3020 Compact HE has an integrated, stainless steel hot water cylinder that holds approximately 8.4 litres of freshwater.

The boiler can produce around 12 litres of 40°C warm water per 30 mins (at a cold water temperature of 10°C). If only the electric heating is used, this capacity is slightly reduced.

The hot water should not be used for drinking

or cooking.

Always flush out the hot water cylinder before use, especially when it has stood empty for some time.



Any steriliser products should be suitable for use with stainless steel.

Avoid steriliser products containing sodium hyperchlorite, for example, as these will cause severe corrosion damage to the hot water cylinder, which is not covered under warranty. Read the product label or contact the product manufacturer for details.



Alde recommends the Truma AquaStar steriliser products.

When the hot water cylinder is in continuous use, it should be drained and refilled once a month. This recreates the air cushion in the hot water cylinder that absorbs pressure surges.



If continuously using the hot water cylinder in a hard water area, fit an inline scale inhibitor to minimise the effects of limescale.

Target hot water temperature is greater than 50°C in normal operation, to prevent the growth of Legionella. Over 50°C, the hot water will be heated to the maximum achievable temperature at the time. This allows the hot water to achieve disinfection temperatures, and increases warm water performance.

If scalding hot water temperatures are a

concern - such as with the young, elderly or infirm - thermostatic mixing valves (TMVs) can be fitted, and may be required by local regulations.



Alde recommends fitting the 3102-002 high temperature TMV.



Always drain down and completely empty the hot water cylinder when there is risk of frost, unless the vehicle is explicitly stated to be self-winterising by the vehicle manufacturer.

Failure to drain the hot water cylinder when there is a risk of frost may result in frost damage, which is not covered under warranty.

Draining Freshwater

1. Switch off the water pump.
2. Open all water taps, showers, etc.
3. Open the safety/drain valve by lifting the yellow tab (Fig.1 [M]): see page 62, or by turning the blue knob (Fig 1.[K]) 90°.
4. The system will drain directly below the vehicle through the clear plastic hose on the safety/drain valve. Check that all water has emptied out (7-10 litres). Leave the valve in

the open position until the next time the hot water cylinder is used.

NB: Check that the red breather valve (Fig.1 [N]) is allowing air to enter the hot water cylinder, when it is being drained, and that the clear plastic hose is not obstructed.

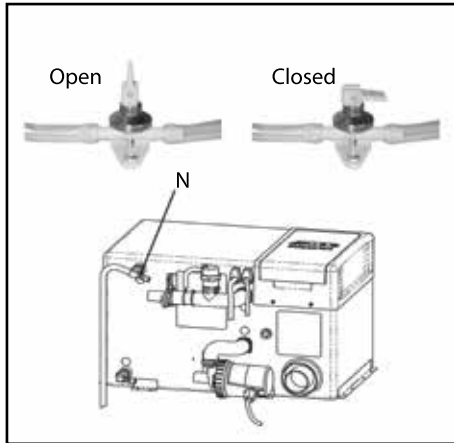

Fig.1

Heat Transfer Fluid

The central heating system is filled with heat transfer fluid (HTF), a solution of 50% ethylene glycol antifreeze and 50% water.



The boiler must not be switched on if there is no HTF in the system.

The antifreeze manufacturer will have a maximum water hardness recommendation. Read the product label or contact the product manufacturer for details.

Alde recommends antifreeze meeting VAG G12++ or G13 specification, and deionised water (0 ppm).

50:50 ethylene glycol antifreeze and water will protect against frost down to -35 to 37°C. A refractometer and/or hydrometer can be used to measure the strength of the antifreeze solution.

Corrosion protection will vary depending on the lifespan of the antifreeze. Read the product label or contact the product manufacturer for details.



Always replace the HTF in accordance with the antifreeze product's lifespan. If in any doubt, replace the HTF after 2 years.

The corrosion inhibitors found in ethylene glycol antifreeze may not be cross-compatible. When topping up or replacing the HTF, ensure the new antifreeze is compatible with the current antifreeze product. Read the product label or contact the product manufacturer for details.



As a rough guideline, blue and red antifreeze products are not compatible with each other, but VAG G12++ and G13 spec antifreeze (purple/magenta) is compatible with both.

Failure to fill with suitable HTF may result in severe damage to your Alde system, which is not covered under warranty.

Filling

The central heating system is filled with HTF through the expansion tank, either by hand, or

using the Alde service pump. Any containers used for handling or storing the HTF should be checked first, and must be visibly clean to avoid introducing contaminants or foreign objects into the system.

Alde recommends using the Alde 1900-811 or 839 twin-motor service pump to fill the system.

To fill the system by hand, unscrew the expansion tank cap (Fig.2 [R]), and lift the circulation pump (Fig.2 [S]) out of the tank (if applicable). Carefully pour the HTF into the tank, and repeat until the fluid level is about 1 cm above the MIN mark when cold.

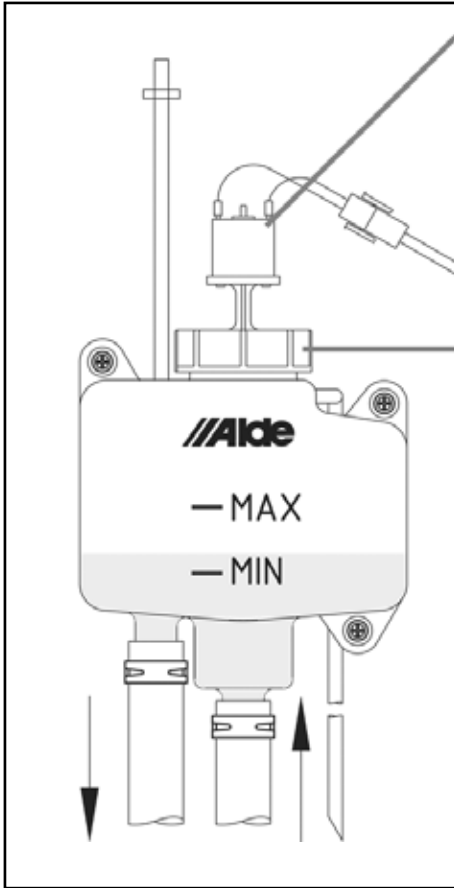

Fig. 2

Central Heating

The boiler is set to an upper limit temperature of 85°C, i.e., the temperature of the heat transfer fluid (HTF) as it circulates around the pipes, radiators, convectors, etc.

To ensure the best performance from hydronic heating, air must be able to circulate freely around the back of the furniture (Fig.3). Air vents, cut into the top and bottom of the furniture, must be unobstructed by carpets, cushions, or stowage, etc.

The full length of a convector should be ventilated for best performance.

i Use gas and electric heating simultaneously for the best performance. The boiler will only use as much energy as is needed, and is 93% efficient on a SEDBUK (seasonal efficiency of domestic boilers in the UK) based test.

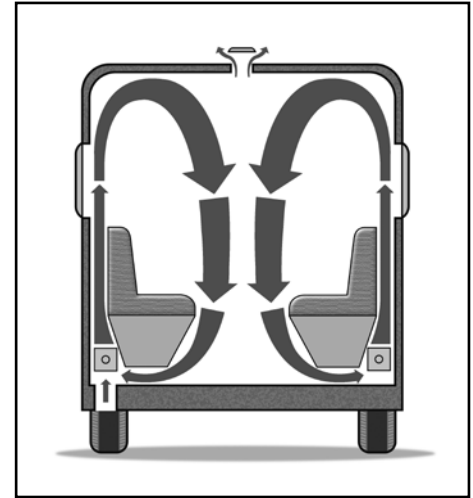

Fig 3

Circulation Pump

A pump is used to circulate the HTF around the central heating system. There are three models of Alde circulation pump.

- 12v expansion tank circulation pump. This light duty pump is ideally suited for holiday-makers, or as an off-grid option for the 230v inline circulation pump.
- 12v inline circulation pump. This heavy duty, variable speed pump is designed for all year round motorcamping.
- 230v inline circulation pump. This heavy duty pump is powered directly by mains electric, suitable for non-touring vehicles.

Bleeding Air

The HTF will contain some air. This is unavoidable. Air bubbles can also be introduced when the system is filled.

In a newly filled central heating system, you will need to bleed air from the bleed points to ensure best performance. There is an automatic air bleed valve on the boiler. There is also an air vent on the expansion tank.

The installer should fit bleed points elsewhere in the system, especially where the pipes step up and down, and on radiators and towel rails. Air will accumulate at these high points and become trapped.



Contact the dealer or installer for details on where the bleed points are in your system, and how to access them.

To bleed the system, set the desired temperature to 30°C and select gas heating on the control panel.

Set the 12v inline circulation pump on the side of the boiler to speed 5 (Fig.1 [D]): see page 62, by turning the blue speed dial clockwise, on the face of the pump motor. NB: Speed is not adjustable if using the 12v circulation pump fitted in the expansion tank.

After 10 mins, set the pump back to its normal running speed (2 for a caravan, 3 for a motorhome).

Now power off the Aide 3020 Compact HE boiler completely, making sure that the circulation pump is not active.

Follow the flow pipe from the boiler, and bleed the system at each bleed point.

If Aide bleed points have been fitted, these are

metal bleed screws mounted on black EPDM rubber connectors (Fig. 4). Have a cloth in hand. To open, turn the screw anti-clockwise between thumb and forefinger. Air will hiss out. When fluid trickles out, close the bleed screw and mop up fluid with the cloth.



Fig. 4

Move on to the next bleed point and repeat, until all bleed points have been attended to.

Air Lock

If enough trapped air accumulates at one point, an air lock can result and prevent the circulation of hydronic heating.

A ramp or steep slope can be used to raise one

end of the vehicle, causing the trapped air to shift around the system. Repeat the full bleed procedure.

To clear a stubborn air lock in under 15 minutes, an Aide-certified service agent can use the Aide 1900-811 or 839 twin-motor service pump.

230v Electric

The Aide 3020 Compact HE boiler has two 230v electric heating elements, outputting 1050W and 2100W, or 3150W combined, and drawing 5A, 9A, and 14A respectively (rounded).

230v breakers, fuses, fused spurs and isolator switches should be rated for 16A.

Before using electric heating, check the current limit on the electric supply you are hooking up to.

- 6A limit, only use 1kW electric heating.
- 10A limit, use 1-2kW electric heating.
- 16A limit, use 1-3kW electric heating.

NB: If the electric supply has unstable voltage, the amperage will also fluctuate.



Aide recommends fitting the 3010-246 load monitor, allowing you to set a limit on the current drawn by the vehicle and the electric heating to automatically accommodate it.

LPG

LPG (liquefied petroleum gas) has two main variants, propane and butane gas. The gas heating in your Aide 3020 Compact boiler can use propane or butane gas as fuel. Many LPG fuels contain a mixture of propane, butane and other additives.

BS 5482 Part 1 states, "For butane cylinders, satisfactory service might not be obtained at temperatures of less than 10°C; the most

FITTED EQUIPMENT- The Alde Heating System

suitable temperature range is from 13°C to 30°C. For temperatures less than 13°C, the use of propane should be considered."

For this reason, Alde recommends using propane gas for all year round gas heating.

LPG cylinders contain both gas and liquid forms. When the cylinder is filled, high pressure transforms the gas into liquid. The liquid reverts to gas when the valve on the cylinder is opened.

LPG is a flammable gas. It can be a fire and explosion hazard if stored or used incorrectly. Store cylinders vertically and securely, to prevent them from toppling.

Do not mount your LPG cylinder horizontally or use liquid phase gas cylinders. Liquid-gas explosion may result. Read the product label or contact product manufacturer for details.

LPG is heavier than air. Should a gas leak occur, floor vents in a caravan or motorhome should allow the gas to escape from the vehicle. For this reason, always ensure floor vents are unobstructed.



The boiler compartment contains the gas connection, floor vents and the flue hoses. Do not place stowage in the boiler compartment.

In the event of a gas leak, or if you smell gas:

- Extinguish all naked flames.
- Open all doors and windows.
- Close all gas valves, including the valve on the cylinder.
- Do not smoke.
- Do not operate any electrical appliances or switches.
- Arrange for immediate inspection of the gas system by a competent person in

accordance with current local regulations.

LPG from the cylinder is reduced in pressure by a regulator, and is supplied to the boiler at low pressure (30mbar). Never use an unregulated high pressure supply.

Where oil and dirt in the gas supply are a concern, gas filters should be fitted to prevent blockage of the boiler gas valve.

NB: Gas heating must not be used while driving your vehicle unless a safety shut-off device is fitted to the gas system. Current local regulations must be adhered to.

Flue

The burning of LPG produces CO₂ (carbon dioxide), a non-toxic, asphyxiant gas.

Exhaust flue gas can cause possible burns and poisoning. Avoid inhaling exhaust flue gas.



Do not position awnings, tents or other enclosures around the flue terminal.

Air supply is essential for clean combustion. The air intake is located in the flue terminal. For best performance, the flue terminal should be well vented. If leaving the gas heating unused for a period, ensure the flue terminal is covered to prevent pest animals nesting in the flue.



Do not obstruct the flue. Be careful not to flood the flue when washing the vehicle.



The gas heating must not be used when refuelling the vehicle at the service station or related facility.

Maintenance

There is no manufacturer's service requirement for the Alde 3020 Compact HE boiler itself. Current **local regulations must be adhered to**. The installation of the boiler should be inspected annually for gas safety.

LPG hoses should be regularly checked for signs of damage and should be replaced, at maximum, after 3 years of use.

Bleed air from the system when newly filled, when the vehicle has been standing unused for a period, and before departing on holiday.

The fluid level in the expansion tank should be about 1cm above the MIN mark when cool. The heat transfer fluid (HTF) should be topped up if below this level, to prevent a break in circulation. Only top up with compatible HTF. NB: Never leave the system empty of HTF.

Always replace the HTF in accordance with the antifreeze product's lifespan. If in any doubt, replace the HTF after 2 years.

Failure to maintain the condition of HTF may result in frost and/or corrosion damage, and is not covered under warranty.

When the hot water cylinder is in continuous use, it should be drained and refilled once a month. This recreates the air cushion in the hot water cylinder that absorbs pressure surges.

Winter

When camping in the winter, always ensure the flue terminal remains unobstructed by snow and ice. Extensions for roof flue terminals, and condensate spouts for side flue terminals are available from Alde.

Check the strength of the HTF (heat transfer fluid) with a hydrometer and/or refractometer. It should measure 50% ethylene glycol antifreeze, or -35 to 37°C.

The central heating can still be used with no freshwater in the system. The air in the hot water cylinder is heated but no damage can result.



Always drain down and completely empty the hot water cylinder when there is risk of frost, unless the vehicle is explicitly stated to be self-winterising by the vehicle manufacturer.

If camping in temperatures below -10°C, consider carrying spare parts in the event of an emergency. Alde recommends a 12v circulation pump for the expansion tank (with cabling), a PCB, and 4-5 litres of ready to use antifreeze. These spare parts should be kept well insulated and in the warmest part of the vehicle; for example, in the wardrobe, near to the expansion tank pipes.

If storing the vehicle for winter, ensure the flue terminal is covered to prevent pest animals nesting in the flue.

If using the light duty 12v circulation pump in the expansion tank, do not leave the central heating on over winter, even with a low desired temperature set.



Air the vehicle over winter without wearing out the light duty pump. Use the programmable Alde control panel to automatically heat the vehicle for 24 hours, once a week.

Troubleshooting

The Alde control panel will display any error messages. See the operating and installation instructions supplied separately.

The system is completely dead, the control panel is blank

- Check the 20mm T3.15 amp glass fuse in the boiler. This is located under the lid of the black plastic service hatch, in a green plastic fuse holder.
- Check the 12v supply to the boiler, it should be above 12v.
- Check the 12v cable is plugged into the boiler. Check the cable is plugged into the Alde control panel.

The boiler will not ignite on gas

- Check the gas cylinder is full. Try a different gas cylinder, ensuring it is propane gas.
- The system may not need to use gas heating, if also using electric heating.
- The fluids in the boiler may already be at operating temperature.

The boiler will not heat on 230v electric

- Check that any 230v isolator switches are on (they will often have an LED indicator).
- Check the 230v supply to the vehicle.
- The fluids in the boiler may already be at operating temperature.

No hot water

- Check that “hot water ignore” is not activated on the Alde control panel.
- Check that constant pumping is not activated on the Alde control panel.
- Check for other conflicting settings on the

FITTED EQUIPMENT- The Alde Heating System

Alde control panel.

- Check the freshwater supply and water pump.

No central heating

- Bleed the system of air.
- Check the fluid level in the expansion tank.
- Check that the circulation pump is responding.
- Check that "hot water boost" is not activated on the Alde control panel.
- Use gas and electric heating.
- Check that vents in the furniture are not obstructed.
- Check the condition of the heat transfer fluid.
- Most vehicles will reach a comfortable temperature within an hour, in non-extreme conditions.

If problems persist, please contact Alde, or your dealer or installer.

Warranty

Alde undertakes to rectify any manufacturing defect or early component failure through normal use that occurs within 12 months of the installation date.

If your Alde boiler develops a fault, your first action should be to contact your dealer or installer, as they will be familiar with your installation and vehicle, and how to make a claim under warranty.

Alde International (UK) Ltd
Huxley Close
Park Farm South
Wellingborough
Northamptonshire
NN8 6AB

Tel. +44 (0) 1933 677765

www.alde.co.uk

Quick Start Guide : 3020 113 Colour Touch

This quick start guide allows end users to confidently use the core features of their Alde control panel. See the operating and installation instructions for the Alde control panel for more details.



Please read the operating instructions for the Alde 3020 Compact HE boiler before using the system.

Starting the System





- Both the control panel and boiler are off.
- To start the system, press the Power button on the control panel. The Splash Screen is displayed and green LED is lit. The boiler will now start with the previously saved settings (factory settings by default). The system will now be drawing variable 0.2-1A of current from the 12v supply.

Standby Screen

The Standby Screen is displayed after the Splash Screen. This screen contains useful information about the status of your heating system.

NB: If Standby Screen is set to "Dark" in Backlight settings, the Standby Screen will not be displayed; the screen will be dark unless touched.

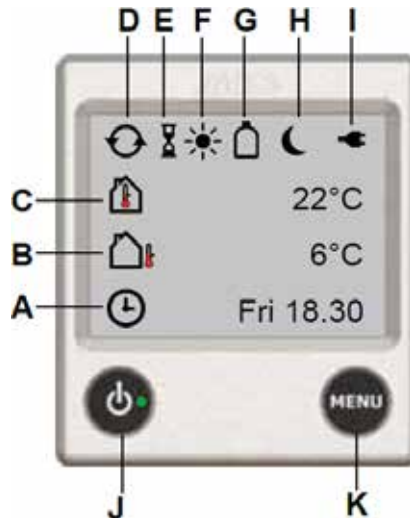

- A. Clock is enabled. Day of the week and time shown.
- B. Outdoor temperature. [Optional outdoor temperature sensor required.]
- C. Room temperature. Measured at the control panel. [Optional discrete room temperature sensors available.]
- D. Central heating circulation pump is active.
- E. Delayed Start/Cycle is enabled.
- F. Day Mode active.
- G. Gas Cylinder Status. Full/empty and active EisEx shown. [Additional accessories required.]
- H. Night Mode active.
- I. 230 V supply. If not displayed, the boiler is not receiving 230 V supply.
- J. Power button. Press to switch system on and off. Lit green LED indicates system is on.
- K. MENU button.

- K. MENU button.
- L. Press to access Main Menu from Standby Screen or Settings Menu.

Main Menu

Press MENU button to access the Main Menu from the Standby Screen or Settings Menu. The screen will revert to the Standby Screen after 30 secs if untouched.



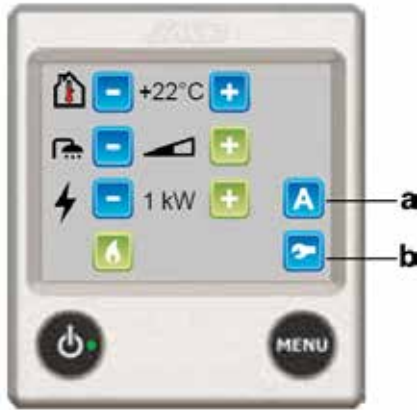

1. Standby Screen. Press MENU button.

2. Main Menu.

a. What's Activated Menu. [Not displayed if no activated functions are detected.]

b. Settings Menu.

Desired Room Temperature

The desired room temperature can be set from 5°C to 30°C, in 0.5 increments.



The World Health Organisation recommends a room temperature of 18-24°C for healthy living.

NB: If Day or Night Mode are active, the temperature cannot be adjusted, and the Plus and Minus buttons will be greyed out.

- The current desired room temperature is displayed.
- Adjust by pressing Plus or Minus button.

Domestic Hot Water

The Alde boiler stores 8.4 Litres of hot water as standard. If the hot water cylinder is empty, the air is heated but no damage can result.



In a good summer, for example, lower the desired temperature on the control panel to around 10°C. The central heating will not circulate (unless the temperature drops to 10°C), but you can still control hot water.

NB: If Day or Night Mode Sans Hot Water are active, the hot water cannot be adjusted, and the Plus and Minus buttons will be greyed out.

- Hot Water Ignore. Volume bar empty. No attempt is made to heat hot water specifically. This saves energy when the freshwater is drained down.
- Hot Water Normal. Volume bar half-full. Hot water is heated to greater than 50°C. NB: If circulation pump is set to Continuous, this option will not be available.
- Hot Water Boost. Volume bar full. Central heating circulation is disabled for 30 mins. Hot water is heated to greater than 65°C. After 30 mins the system reverts to Hot Water Normal.
- Adjust by pressing Plus or Minus button.

Electric Heating

Check that 230v supply is displayed on the Standby Screen. The Alde boiler is programmed

to use power economically and there are times when it may use no power at all, even if set to 3kW.

- Select Off, 1, 2 or 3kW electric heating. More power equals better performance, but may be restricted by the current (amps) limit on the electric hook-up.

- Adjust by pressing Plus or Minus button.

Max current draw from 230v supply is 4.5A on 1kW, 9A on 2kW, 14A on 3kW. If the electric supply has unstable voltage, the amperage will also fluctuate.

Gas Heating

The Alde boiler is programmed to use power economically. The gas burner has two stages, shifting dynamically between low or full flame. There are times when it may use no power at all, even if gas heating is selected.

- Press the Flame button to select gas heating. Green is on, blue is off.

Use both gas and electric heating for best performance.

Shutting Down the System

To save energy, the control panel only updates the boiler after the last adjustment is made. Wait 10 secs before shutting down the system to ensure the boiler is updated.

- Press the Power button again. The screen goes dark, the green LED is unlit. The system is off.

Setup

Most UK installations do not need setting up in the Settings Menu, and use default factory settings.

Restore Default Factory Settings

Before using the system for the first time, restore default factory settings. Your control panel may have been tested by the dealer or installer, and some settings may have been changed.

1. Press Tool button to access the Settings Menu (bottom right in Main Menu).
2. Press down arrow, until Reset button is displayed.
3. Press the Reset button to proceed.

Setup Expansion Tank Pump

To use the 12v circulation pump in the expansion tank, you must set it up. This is not a default factory setting.

NB: Under factory settings, the system will use the 12v inline circulation pump by default.

1. Press Tool button to access the Settings Menu (bottom right in Main Menu).
2. Press down arrow, until Circulation Pump button is displayed.
3. Press Circulation Pump button, select Expansion Tank Pump to proceed.

Set up Antimicrobial Function

To actively kill Legionella, set up the Antimicrobial function. At 2:00 every night, the hot water will be heated to over 65°C for 30 mins. This further reduces the risk of Legionella.

1. Press Tool button to access the Settings Menu (bottom right in Main Menu).
2. Press down arrow, until Antimicrobial button is displayed.
3. Press Antimicrobial button to proceed.

Setup Standby Screen for Bedtime

The backlight on the Standby Screen can be disturbing if the control panel is visible from your bed. It can be inverted for white text on black background.

1. Press Tool button to access the Settings Menu (bottom right in Main Menu).
2. Press down arrow, until Backlight button is displayed.
3. Press Backlight button, select Inverted to proceed.

Maintenance

The Alde control panel requires no maintenance, other than cleaning of the screen as needed. Use a microfibre cloth to clean the touchscreen.

NB: Consider removing the Alde control panel over winter, if the vehicle is to be kept in storage and is susceptible to damp.

Troubleshooting

Any error messages will be displayed on the Standby Screen. Error messages can be cleared by switching off 12v supply to the boiler for 10 secs.

The system is completely dead, the control panel is blank

- Check the 20mm T3.15Amp glass fuse in the boiler. This is located under the lid of the black plastic service hatch, in a green plastic fuse holder.
- Check the 12v supply to the boiler, it should be above 12v.
- Check the 12v cable is plugged into the boiler. Check the cable is plugged into the Alde control panel.

“Panel failure 1” & and “Panel failure 2”

- Moisture is trapped in the control panel.
- Remove the Alde control panel from the vehicle and air in a warm, dry place overnight.

“Gas failure”

- Out of gas or gas is not igniting.
- Check the gas cylinder is full. Try a different gas cylinder, ensuring it is propane gas.

FITTED EQUIPMENT- The Alde Heating System

“Overheat red fail” or “Overheat blue fail”

- Bleed the system of air.
- Check the fluid level in the expansion tank. It should be 1cm above min mark when cool.
- Check the circulation pump is responding.
- Wait 15 mins for the fluid to cool down.

“Overheat PCB”

- Failsafe in boiler has triggered.
- Check the fluid level in the expansion tank. It should be 1 cm above the Min mark when cool.
- Check the boiler compartment is ventilated, and that the vents are unobstructed. Do not place stowage in the boiler compartment.

“Fan failure”

- Combustion fan speed too low. Bearing may be stiff after a period of disuse.
- Automatically clears after 5 mins. Please try again.

“Connection failure”

- Loose connection between Alde control panel and boiler.
- Unplug cable at the control panel and boiler, then carefully plug back in.
- Check there is slack on the cable at the control panel, but not excessive weight from free-hanging/unmanaged cable.

“Window open”

- Optional window sensor has triggered, gas heating is suspended. Automatically clears and gas heating resumes when window is closed.

“Connection fail ext”

- Break in communications between Alde control panel and daisy-chained third party control panel.
- Check the cable between the Alde control panel and third party control panel.

“Low battery”

- 12v supply to boiler has dropped below 10.5v, possibly causing system brownout.
- Automatically clears when 12v supply reaches 11v.

“No match Heater/Panel”

- Control panel is incompatible with boiler PCB.
- Check control panel part number. Control panel 3020-013 is for 3020 A-series boiler, 3020-113 is for 3020 HE-series boiler.

If problems persist, please contact Alde, or your dealer or installer.

For frequently asked questions, or download all instruction manuals, please visit Alde’s web site at:

www.alde.co.uk

CAPRICE COOKER



Never use the cooker as a space heater.



Before using the appliance please ensure that you are aware of the following:

- Appliance and accessible parts become hot during use.
- Avoid touching heating elements.
- Children less than 8 years of age shall be kept away unless continuously supervised.
- This appliance can be used by children aged from 8 years and above, persons with reduced physical, sensory or mental capabilities and/or lack of experience and knowledge only if they have been given supervision or instruction concerning use of the appliance in a safe way and understand the hazards involved.
- Children shall not play with the appliance.
- Cleaning and user maintenance shall not be made by children without supervision.
- Unattended cooking on a hob with fat or oil can be dangerous and may result in fire.
- Never extinguish a fire with water; switch off the appliance and cover flame with lid or fire blanket.
- Danger of fire: Do not store items on the cooking surface.
- Do not use harsh abrasive cleaners or sharp metal scrapers to clean the oven door glass since they can scratch the surface, which may result in shattering of the glass.
- Never use a steam cleaner to clean the appliance.

Operation

The burners on this appliance have fixed aeration and no adjustment is required. The burners should flame as follows:

Propane - the flames should burn quietly with a blue/green colour with no sign of yellow tips.
Butane - normally on initial lighting, a small amount of yellow tipping will occur. This then increases slightly as the burner heats up.



Using the Hotplate Gas Burners

Ensure that the glass lid is open before turning on the burners.

Glass lids may shatter when heated. Turn off all burners before shutting the lid.

The glass lid has a tendency to snap shut towards the lowered position. Make sure all fingers are removed from the appliance when closing the lid.

Remove all spillages from the glass lid before opening.

Children should be supervised to ensure that they do not play with the appliance.

1. Ensure gas cylinder/supply is connected and turned on. In the event of a gas smell turn off at gas cylinder/mains and contact supplier.
2. Flame supervision: each burner is controlled individually and is monitored by a thermocouple probe. In the event of the burner flames being accidentally extinguished, turn off the burner control and do not attempt to re-ignite the burner for at least one minute.
3. To light: push in the control knob and turn to full rate - large flame (⚠). Light the hob by depressing the ignition button, which

FITTED EQUIPMENT - The Caprice Cooker

is located on the fascia. It is necessary to hold the knob depressed after the burner has ignited for approximately 10 - 15 seconds, to allow the thermocouple probe to reach temperature, before releasing the knob. Should the flame go out when the knob is released, the procedure should be repeated holding the knob depressed for slightly longer.

4. If the burner has not lit within 15 seconds the control knob should be released and the burner left for at least 1 minute before a further attempt to ignite the burner.
5. For simmering, turn the knob further anti-clockwise to the low rate position.
6. To turn off: turn the control knob until the line on the control knob is aligned with the dot on the control panel. Always make sure the control knob is in the off position when you have finished using the hotplate burners.
 - Each burner will support pans from Ø10 to Ø22cm; care should be taken not to overload the appliance as performance may be reduced.
 - The following pan sizes are the maximum we recommend:
 - Electric hotplate: - Ø180mm (dual fuel only)
 - Auxiliary burner: - Ø200mm
 - Semi-rapid burner: 2 x Ø200mm or 1 x Ø220mm with 1 x Ø180mm
 - When using small pans the flames should not spread beyond the base of the pan as this will reduce the efficiency of the burner.
 - Avoid old or misshapen pans as these may cause instability.

FITTED EQUIPMENT - The Caprice Cooker

- The lid must be opened fully prior to using the hotplate burners.

Using the Electric Hotplate (Dual Fuel Models)

Ensure power is switched on. The hotplate control is numbered from 1 to 6. To turn it on, rotate the knob either clockwise or anti-clockwise to the required position. Position 1 is the coolest setting. To turn off, rotate the knob until the line or pointer on the knob lines up with the zero on the control panel.

The hotplate is a sealed construction and transfers heat through conduction. For maximum efficiency a correctly sized pan with a flat heavy gauge base should be used. Pan size should be the same or slightly larger (up to 1" / 2.5cm oversize).

Before using your hotplate for the first time, we recommend that you prime and season it.

To prime the hotplate

Switch on the hotplate for a short period, without a pan, to harden and burn off the coating. Use a medium to high setting for 3-5 minutes. A non-toxic smoke may occur during this process. Allow it to cool, then season.

To season the hotplate

First heat the hotplate for 30 seconds on a medium setting, and then switch off. Pour a minimal amount of unsalted vegetable oil onto a clean dry cloth or paper towel, and apply a thin coat of oil to the hotplate surface. Wipe off any excess oil, then heat the hotplate on a medium setting for 1 minute. Occasional seasoning will help to maintain the hotplate's appearance.

Using the Grill

- Ensure gas cylinder/supply is connected and turned on. In the event of a gas smell turn off at gas cylinder/mains and contact supplier.
- To light: Open door, push in the control knob and turn to full rate-large flame. Hold a lighted match or taper to the burner and push the control knob in and hold. The burner should ignite and the control knob should be held in for 10 -15 seconds before release. If the burner goes out, repeat procedure holding control knob for slightly longer.
- For models fitted with spark ignition the procedure is similar except that the burner can be ignited by depressing the ignition button, which is located on the fascia. Ignition must be carried out with the door open, and if the burner has not lit within 15 seconds the control knob should be released and the grill left for at least 1 minute before a further attempt to ignite the burner.
- Note: the grill must only be used with the door open.
- On first use of the grill, it should be heated for about 20 minutes to eliminate any residual factory lubricants that might impart unpleasant smells to the food being cooked. A non-toxic smoke may occur when using for the first time so open any windows and turn on mechanical ventilators to help remove the smoke.
- Although the grill does heat up quickly, a few minutes preheat is recommended.
- Flame Failure Device (FFD): the grill burner is fitted with a flame sensing

probe, which will automatically cut off the gas supply in the event of the flame going out. In the event of the burner flames being accidentally extinguished, turn off the burner control and do not attempt to re-ignite the burner for at least 1 minute. It is normal for the flames on this burner to develop yellow tips as it heats up.

- A reversible grill pan trivet enables the correct grilling height to be achieved. Fast Toasting: position trivet high
Grilling sausages: position trivet high
Grilling steak/bacon: position trivet high
Grilling chops etc: position trivet low
Slow grilling: remove the trivet
- To turn off: turn the control knob until the line on the control knob is aligned with the dot on the control panel. Always make sure the control knob is in the off position when you have finished grilling.



The grill area can get hot when the oven is in use, even if the grill is switched off. Care should be taken when removing pans from the grill, e.g. by use of oven gloves, and by making use of the removable grill pan handle.

The grill pan supplied is multi-functional, for use in grill or oven.

The handle design allows removal or insertion while the pan is in use.



Always remove the handle when the pan is in use.

The grill MUST only be used with the door open.

Using the Oven

1. Ensure gas cylinder/supply is connected and turned on. In the event of a gas smell turn off at gas cylinder/mains and contact supplier.
2. To light: open door, push in the control knob and turn to full rate (240°C). Hold a lighted match or taper to the burner and push the control knob in and hold. The burner should ignite and the control knob should be held in for 10 - 15 seconds before release. If the burner goes out, repeat procedure holding control knob for slightly longer.
3. For models fitted with spark ignition the procedure is similar except that the burner can be ignited by depressing the ignition button, which is located on the fascia. Ignition must be carried out with the door open, and if the burner has not lit within 15 seconds the control knob should be released and the oven left for at least 1 minute before a further attempt to ignite the burner.
4. Place the oven shelf in the required position and close the door.
5. Set the control knob to required temperature. Although the oven heats up quickly, it is recommended that a 10 minute preheat be allowed. The oven should be up to full temperature in about 15 - 20mins.
6. To turn off: turn the control knob until the line on the control knob is aligned with the dot on the control panel.
7. Shelf: the shelf has been designed to allow good circulation at the rear of the oven and is also fitted with a raised bar

to prevent trays or dishes making contact with the back of the oven. To remove a shelf, pull forward until it stops, raise at front and remove. Installation of a shelf is a reverse of this procedure.



Before first use, heat the oven for about 30 minutes at 200°C, to eliminate any residual factory lubricants that might impart unpleasant smells to the meals being cooked. A non-toxic smoke may occur when using for the first time so open any windows and turn on mechanical ventilators to help remove the smoke. Always ensure food is properly cooked prior to serving.

Oven Temperature Control

The temperature in the oven is controlled by a thermostatic gas tap and is variable over the range 130°C to 240°C. The temperatures indicated refer to the centre of the oven and at any particular setting the oven will be hotter at the top and cooler towards the base.

The variation between top and centre, and centre to bottom is approximately equivalent to one gas mark. Good use can be made of the temperature variation in that several dishes requiring different temperatures may be cooked at the same time. In this way maximum benefit can be obtained from the gas used to heat the oven. Care should be taken not to overload the oven, adequate spacing being needed to allow free circulation for heat.

FITTED EQUIPMENT - The Caprice Cooker

Cooking Guidelines

Although the oven heats up quickly, it is recommended a 10 minute preheat be allowed. The oven should reach full temperature in 15 - 20 minutes.

Most cookery books give details of the shelf positions and gas mark settings for each recipe. When roasting with aluminium foil care must be taken that the foil does not impair circulation or block the oven flue outlet.

Do's and Don'ts

DO Read the user instructions carefully before using the appliance for the first time.

DO Allow the oven to heat before using for the first time, in order to expel any smells before the introduction of food.

DO Clean the appliance regularly.

DO Remove spills as soon as they occur.

DO Always use oven gloves when removing food shelves and trays from the oven.

DO Check that controls are in the off position when finished.

DO NOT Allow children near the cooker when in use. Turn pan handles away from the front so that they cannot be caught accidentally.

DO NOT Allow fats or oils to build up in the oven trays or base.

DO NOT Use abrasive cleaners or powders that will scratch the surface of the appliance.

DO NOT Under any circumstances use the oven as a space heater.

DO NOT Put heavy objects onto open grill and oven doors.

Gas Mark	Temperature (Centre of the Oven)			Dish
	265-275°F	130-135°C	Very Cool	
1/4-1/2	265-275°F	130-135°C	Very Cool	Meringues
1	285	140	Cool	Stewed Fruit
2	300	150	Cool	Rich fruit cake, rice pudding
3	330	165	Warm	Baked custard, shortbread fingers
4	355	180	Moderate	Victoria sandwich
5	385	195	Fairly Hot	Whisked sponges, ginger nuts
6	410	210	Hot	Short crust pastry
7	430	220	Hot	Bread, Scones, Flaky pastry
8	445	230	Very Hot	Puff Pastry
9	465	240	Very Hot	Quick Browning

Leaks

If a smell of gas becomes apparent, the supply should be turned off at the cylinder IMMEDIATELY.

- Extinguish naked lights including cigarettes and pipes.
- Do not operate electrical switches.
- Open all doors and windows to disperse any gas escape.
- Never check for leaks with a naked flame; leak investigation should be carried out using a leak detector spray.
- Check the gas is not escaping from an unlighted appliance.

Maintenance

This appliance needs little maintenance other than cleaning. After the unit has cooled all parts should be cleaned using warm soapy water. Do not use abrasive cleaners, steel

wool or cleansing powders. When cleaning the burner ring it is essential to ensure that the holes do not become blocked. The control knobs are a push fit and can be removed for cleaning. They are interchangeable without affecting the sense of operation.

Service

The Caprice cooker must be serviced at least once every 12 months. All servicing must be carried out by an approved competent person. Before any service work is started, the appliance should have been left to cool and be disconnected at the mains socket. After each service the appliance must be checked for gas soundness.

For service, please contact your authorised local Service Agent giving details of the model and serial number on the data badge plus date of purchase.

Operating Instructions

- Ensure that the gas cylinder is turned on.
- In the event of a gas smell turn off at the cylinder and contact your Thetford agent.
- The use of a gas cooking appliance results in the production of heat and moisture in the room in which it is installed. Ensure that the kitchen is well ventilated, keep natural ventilation holes open or install a mechanical ventilation device (mechanical extractor hood).
- Prolonged intensive use of the appliance may call for additional ventilation, for example opening a window, or more effective ventilation, for example increasing the level of mechanical ventilation where present.

The Linear Hob
 Hotplate burners.

- Glass lids may shatter when heated. Turn off all burners before shutting the lid.
- The glass lid has a tendency to snap shut towards the lowered position. Make sure that all fingers are removed from the appliance when closing the lid.



Each burner is controlled individually and is monitored by a flame supervision device. In the event of the burner flames being accidentally extinguished, turn off the burner control and do not attempt to re-ignite the burner for at least 1 minute. The respective knob positions are shown.

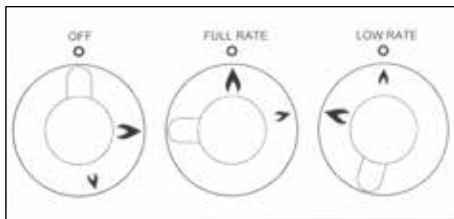

To light the burner, press in and turn the knob anti-clockwise to the full rate position and press the ignition button located on the front of the oven control fascia. It is necessary to hold the knob depressed during ignition and for approximately 15 seconds after the burner has lit to allow the probe to reach temperature. Should the flame go out when the knob is released, the procedure should be repeated holding the knob depressed for slightly longer.

For simmering, turn the knob further anti-clockwise to the low rate position. To turn the

burner off, rotate knob fully clockwise until the line on the knob lines up with the dot on the control panel. The burners on this appliance have fixed aeration and no adjustment is required. Depending on the gas being used, the burners should flame as follows:

Propane: the flames should burn quietly with a blue/green colour with no signs of yellow tips.

Butane: normally on initial lighting, a small amount of yellow tipping will occur and this slightly increases as the burner heats up.

Care should be taken not to overload the appliance as reduced performance may result.

When using small pans, the flames should not spread beyond the base of the pan as this will reduce the efficiency of the burner.

The Midi Oven and Grill

- Accessible parts may be hot when the grill is used! Young children should be kept away.
 - The heat deflector below the fascia is positioned in the out position to avoid heat deflection to the knobs during grilling.
 - While the grill is operating never adjust the deflector without using hand protection.
 - Only use the grill with the door open and always remove the handle from the pan when in use.
- Ensure gas cylinder/supply is connected and turned on. In the event of a gas smell turn off at the gas cylinder/mains and contact your Retailer.
 - Remove all accessories and packing that may be in the grill including any plastic coating that may be protecting the grill cavity surfaces. Clean the interior before using it for the first time; use soap and water and rinse carefully.
 - To light: open the door, push in the control knob and turn to full rate. Press down the ignition button located on the oven fascia. It is necessary to hold the knob for approximately 15 seconds before release. If the burner goes out, repeat the procedure holding the control knob for slightly longer.



Ignition must be carried out with the door open.

- On first use of the grill, it should be heated for about 20 minutes to eliminate any

residual factory lubricants that might impart unpleasant smells to the food being cooked. A non-toxic smoke may occur when using for the first time so open any windows and rooflights to remove the smoke.

- Although the grill heats up quickly, it is recommended that a few minutes preheat be allowed.
- Flame Failure Device (FFD): the grill burner is fitted with a flame sensing probe which will automatically cut off the gas supply in the event of the flame going out. In the event of the burner flames being accidentally extinguished, turn off the burner control and do not attempt to re-ignite the burner for at least 1 minute.
- It is normal for the flames on this burner to develop yellow tips as it heats up, particularly on butane.
- Variation in cooking can be achieved by using the control knob to regulate the heat setting. In addition, the grill pan trivet can be reversed or removed to give a greater choice of grilling height. Always use the highest trivet position for fast toasting.
- To turn off: turn the knob until the line on the control knob is aligned with the dot on the grill fascia. Always make sure that the control knob is in the off position when you have finished grilling.

Oven

- Ensure the gas cylinder is connected and turned on. In the event of a gas smell turn off the gas at the cylinder and contact Thetford.
- Remove all accessories and packing that may be in the oven and clean the interior before using it for the first time.
- To light: open door, push in the control knob and turn to gas mark 9. Depress the ignition button located on the fascia. Ignition must be carried out with the door open, and if the burner has not lit within 15 seconds the control knob should be released and the oven left open for at least 1 minute before further attempt to ignite the burner.
- Place the oven shelf in the required position and close the door. Set the control knob to approximately gas mark 5 and heat the oven for about 30 minutes to eliminate any residual factory lubricants that might impart unpleasant smells to the meals being cooked.
- Although the oven does heat up quickly, it is recommended a 10 minute preheat be allowed. The oven should reach full temperature in about 15 - 20 minutes.
- To turn off: turn the control knob until the dot on the control knob is aligned with the dot on the fascia.
- Flame Failure Device: the oven burner is fitted with a flame sensing probe which will automatically cut off the gas supply in the event of the flame going out.
- Oven shelf: the oven shelf is designed to allow good circulation at the rear of the oven and is fitted with a raised bar to prevent trays or dishes making contact with

the back of the oven. Additional shelves are available through your retailer.

Temperature Control

The temperature in the oven is controlled by a thermostatic gas tap and is variable over the range 130°C to 240°C. The temperatures

indicated in the table below refer to the centre of the oven and at any particular setting the oven will be hotter at the top and cooler towards the base. The variation between top and bottom is approximately equivalent to one gas mark. Good use can be made of the temperature variation in that several dishes

requiring different temperatures may be cooked at the same time. In this way maximum benefit can be obtained from the gas used to heat the oven. Care should be taken not to overload the oven, adequate spacing being used to allow free circulation of heat.

Gas Mark	Temperature (Centre of Oven)			Dish
	°F	°C	Setting	
1/4 - 1/2	265 - 275	130-135	Very Cool	Meringues
1	285	140	Cool	Stewed Fruit
2	300	150	Cool	Rich fruit cake, rice pudding
3	330	165	Warm	Baked custard, shortbread fingers
4	355	180	Moderate	Victoria sandwich
5	385	195	Fairly Hot	Whisked sponges, ginger nuts
6	410	210	Hot	Short crust pastry
7	430	220	Hot	Bread, scones, flaky pastry
8	445	230	Very Hot	Puff pastry
9	465	240	Very Hot	Quick browning

Cooking Guidelines

The pan supplied with the appliance is multi-functional, for use with the grill and the oven. Always remove the handle when in use.

Best results will be obtained by using the shelf recommendations from the recipe. It is not necessary to preheat the oven but advisable for a range of dishes. The oven is capable of full temperature in 15 - 20 minutes.

Most cookery books give details of the shelf positions and gas mark settings for each recipe. If in doubt about a recipe you intend to use, study the recipe carefully and then find a similar dish in the guide and use the recommended gas mark. When roasting with aluminium tin foil care must be taken that the foil does not impair circulation or block the oven flue outlet.

Do's and Don'ts

DO read the user instructions carefully before using the appliance for the first time.

DO allow the oven to heat before using for the first time, in order to expel any smells before the introduction of food.

DO clean the appliance regularly.

DO remove spills as soon as they occur.

DO always use oven gloves when removing food shelves and trays from the oven.

DO check that controls are in the off position when finished.

DO NOT allow children near the cooker when in use. Turn pan handles away from the front so that they cannot be caught accidentally.

DO NOT allow fats or oils to build up in the oven trays or base.

DO NOT use abrasive cleaners or powders that will scratch the surfaces of the hotplate and oven.

DO NOT allow the door to fall down: lower it by hand.

DO NOT under any circumstances use the oven as a space heater.



Ensure that the ceramic ball mixer tap arm is clear from the oven lid before raising it. Failure to do so could accidentally switch on the tap when lifting the glass lid.

Maintenance and Servicing

This appliance needs little maintenance other than cleaning. All parts should be cleaned using warm soapy water. Do not use abrasive cleaners, steel wool or cleansing powders. When cleaning the burner ring it is essential to ensure that the holes do not become blocked. The control knobs are a push fit and can be removed for cleaning. They are interchangeable without affecting the sense of operation.



All cooking equipment must be serviced at least once every 12 months. All servicing must be carried out by an approved competent person. Before any service work is started, the appliance should have been left to cool. After each service the appliance must be checked for gas soundness.

For service, please contact your authorised local Service Agent giving details of the model and serial number on the data badge plus date of purchase.



Precautions to avoid possible exposure to excessive microwave energy

- Do not attempt to operate this oven with the door open since open-door operation can result in harmful exposure to microwave energy. It is important not to remove or tamper with the safety interlocks.
- Do not place any object between the oven front face and the door or allow soil or cleaner residue to accumulate on sealing surfaces.
- If the door or door seals are damaged, the oven must not be operated until it has been repaired by a competent person: (1) door (bent), (2) hinges and latches (broken or loosened), (3) door seals and sealing surfaces.
- It is hazardous for anyone other than a competent person to carry out any service or repair operation that involves the removal of a cover which gives protection against exposure to microwave energy.
- Liquids or other foods must not be heated in sealed containers since they are liable to explode.
- The appliance is not intended for use by

young children or infirm persons without supervision. Young children should be supervised to ensure that they do not play with the appliance.

- Only allow children to use the oven without supervision when adequate instructions have been given so that the child is able to use the oven in a safe way and understands the hazards of improper use.

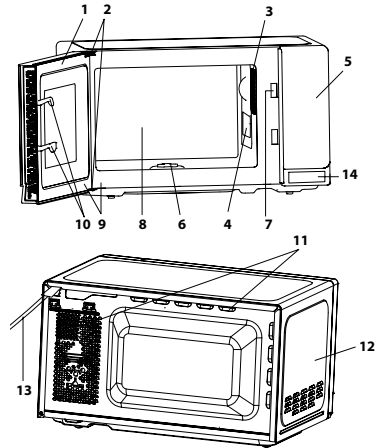
Oven

1. Door
2. Door hinges
3. Oven lamp
4. Waveguide cover (DO NOT REMOVE)
5. Control panel
6. Coupling
7. Door latches
8. Oven cavity
9. Door seals and sealing surfaces
10. Door safety latches
11. Ventilation openings
12. Outer cabinet
13. Power supply Cord
14. Door opening button

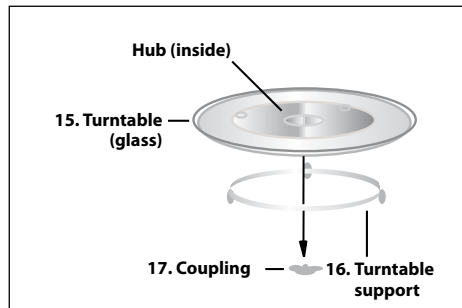

Accessories:

Check to make sure the following accessories are provided:

(15) Turntable (16) Turntable support (17) Coupling

Place the turntable support in the centre of the oven floor so that it can freely rotate around the coupling. Then place the turntable support so that it locates firmly into the coupling.

To avoid turntable damage, ensure dishes and containers are lifted clear of the turntable rim when removing them from the oven.

 The waveguide cover is fragile and as such care should be taken when cleaning inside the oven to ensure that it is not damaged.

Always operate the oven with the turntable and turntable support fitted correctly. This promotes thorough, even cooking. A badly fitted turntable may rattle, may not rotate correctly and could cause damage to the oven. All food and containers of food are always placed on the turntable for cooking.

The turntable normally rotates clockwise.

However the rotary direction may change each time you restart the oven. This does not affect cooking performance.

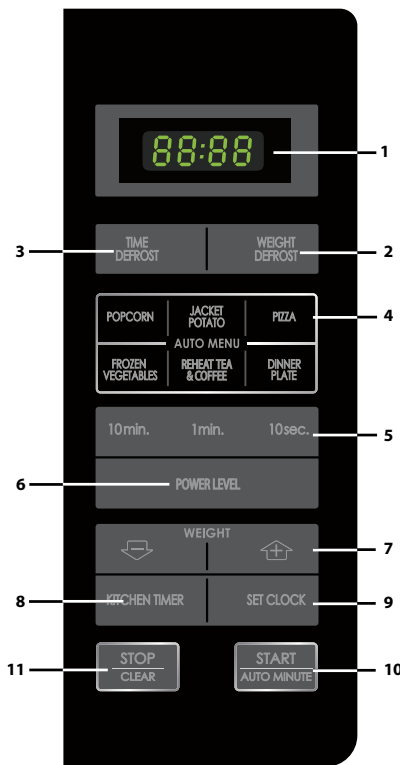

1. Digital Display
2. WEIGHT DEFROST key
3. TIME DEFROST key

4. AUTO MENU keys

POPCORN	Popcorn
JACKET POTATO	Jacket Potato
PIZZA	Pizza
FROZEN VEGETABLES	Frozen Vegetables
REHEAT TEA & COFFEE	Beverage
DINNER PLATE	Dinner Plate

5. TIME keys

6. **POWER LEVEL** Key: Press to select microwave power level.

7. **WEIGHT** keys (up and down)

8. **KITCHEN TIMER** key. Press to use a minute timer, or to programme standing time.

9. **SET CLOCK** key.

10. **START/AUTO MINUTE** Key

11. **STOP/CLEAR** key.

Setting the Clock

Your oven has a 24 hour clock: this will lose time each time the motorhome is disconnected from 230V power.

1. Press the **SET CLOCK** key once and "0:00" will flash.
2. Press the time keys and enter the current time. Enter the hours by pressing the **10min.** key and enter the minutes by pressing **1 min.** and **10 sec.** keys.
3. Press the **SET CLOCK** key to finish clock setting.

MANUAL OPERATION

To open the oven door, push the door opening button.

Starting the oven

Prepare and place the food in a suitable container onto the turntable or place directly onto the turntable. Close the door and press the **START/AUTO MINUTE** key after selecting the desired cooking mode.

If the cooking programme has been set and the **START/AUTO MINUTE** key is not pressed in 1 minute, the setting will be cancelled.

The **START/AUTO MINUTE** key must be pressed to continue cooking if the door is opened during cooking. The audible signal will sound once when pressed, insufficient pressure will not provide a response. Use the **STOP/CLEAR** key to:

- Erase a mistake during programming
- Stop the oven temporarily during cooking.
- Cancel a programme during cooking, press the **STOP/CLEAR** key twice.

Programs

MANUAL COOKING/ MANUAL DEFROSTING

- Enter the cooking time and use microwave power levels 100p to 10p to cook or defrost.
- Stir or turn the food, where possible 2 - 3 times during cooking.
- After cooking, cover the food and leave to stand, where recommended.
- After defrosting, cover the food in foil and leave to stand until thoroughly defrosted.

EXAMPLE

To cook 2 minutes and 30 seconds on 70% microwave power.

- Input the power level by pressing the

POWER LEVEL key 4 times for 70p.

- Enter the cooking time by pressing the 1min key twice and then the **10 sec** key 3 times.
- Press the **START/AUTO MINUTE** key to start the timer. (The display will count down through the set cooking/ defrosting time.)



When the oven starts, the oven lamp will light and the turntable will rotate clockwise or anticlockwise.

- If the door is opened during cooking/ defrosting to stir or to turn over food, the cooking time on the display stops automatically. The cooking/defrosting time starts to count down again when the door is closed and the **START/AUTO MINUTE** key is pressed.
- When cooking/defrosting is complete, open the door or press **STOP/CLEAR** key and the time of day will reappear on the display, if the clock has been set.
- If you wish to know the power level during cooking, press the **POWER LEVEL** key. As long as your finger is touching the **POWER LEVEL** key, the power level will be displayed.

IMPORTANT

- Close the door after cooking/defrosting. Please note that the light will remain on when the door is open; this is for safety reasons to remind you to close the door.
- If you cooked the food over the standard time with only 100p, the power of the oven will lower automatically to avoid overheating. (The microwave power level

will be reduced.)

Cooking Mode	Standard Time
Microwave 100p	30 minutes

Other Convenient Functions

SEQUENCE COOKING

This function allows you to cook using up to 2 different stages which can include manual cooking time and mode and/or time defrost as well as weight defrost function. Once programmed there is no need to interfere with the cooking operation as the oven will automatically move onto the next stage. If one stage is defrosting, it should be the first stage.

Note: Auto Menu cannot be set as one of the multiple sequences.

EXAMPLE

If you would like to defrost the food for 5 minutes, then cook with 80p microwave power for 7 minutes, the steps are as follows:

1. Press the **TIME DEFROST** key once, the LED display will show dEF2.
2. Enter the cooking time by pressing the **1min.** key 5 times.
3. Input the power level (80p) by pressing the **POWER LEVEL** key 3 times.
4. Enter the cooking time by pressing the **1min.** key 7 times.
5. Press the **START/AUTO MINUTE** key once to start cooking.

AUTO MINUTE FUNCTION

The **START/AUTO MINUTE** key allows you to operate the two following functions:

1. Direct Start

You can automatically start cooking on 100P microwave power level for 1 minute by pressing the **AUTO MINUTE** key.

2. Extend the cooking time

You can extend the cooking time during manual cooking, time defrost and Auto Menu operation in multiples of 1 minute if the **START/AUTO MINUTE** key is pressed while the oven is in operation. During the weight defrost, the cooking time cannot be increased by pressing the key.

To cook/defrost food in a microwave oven, the microwave energy must be able to pass through the container to penetrate the food. Therefore it is important to choose suitable cookware.

Round/oval dishes are preferable to square/oblong ones, as the food in the corners tends to overcook. A variety of cookware can be used as listed on page 74.

CLEANING TIP: For easier cleaning of your oven.

Place half a lemon in a bowl, add 300ml (1/2 pint) water and heat on 100% for 10 - 12 minutes. Wipe the oven clean using a soft, dry cloth.

TROUBLESHOOTING

Keep the power supply cord away from heated surfaces. If you think that the oven is not working properly there are some simple checks you can carry out yourself before calling an engineer. This will help prevent unnecessary service calls if the fault is something simple.

Follow this simple check. Place half a cup of water on the turntable and close the door. Programme the oven to cook for 1 minute using 100% microwave power.

1. Does the lamp come on when cooking?
2. Does the turntable rotate?
3. Does the cooling fan work? (Check by placing hand above the air vent openings.)
4. After 1 minute does the audible signal sound?
5. Is the water in the cup hot?
6. After 3 minutes, does the heating element become red?

If you answered NO to any question first check that the oven is plugged in properly and the fuse has not blown. If there is no fault with either, check against the troubleshooting chart on page 75.

Notes:

- The door seal stops microwave leakage during oven operation, but does not form an airtight seal. It is normal to see light or drops of water or feel warm air around the oven door. Food with a high moisture content will release steam and cause condensation inside the door which may drip from the oven.

- **Repairs and modifications:** Do not attempt repairs and modifications yourself: these must be carried out by a qualified engineer.
- **Outer cabinet and lamp access:** Never remove the outer cabinet. This is very dangerous due to high voltage parts inside which must never be touched. Your oven is not fitted with a lamp access cover. If your lamp fails, do not attempt to replace the lamp yourself; call a SHARP approved service facility.

Cookware	Microwave Safe	Comments
Aluminium foil foil containers	✓/x	Small pieces of aluminium foil can be used to shield food from overheating. Keep foil at least 2cm from the oven walls, as arcing may occur. Foil containers are not recommended unless specified by the manufacturer, e.g. Microfoil; follow instructions carefully.
Browning dishes	✓	Always follow the manufacturer's instructions. Do not exceed heating times given. Be very careful as these dishes become very hot.
China and ceramics	✓/x	Porcelain, pottery, glazed earthenware and bone china are usually suitable, except for those with metallic decoration.
Glassware e.g. pyrex	✓	Care should be taken if using fine glassware as it can break or crack if heated suddenly.
Metal	x	It is not recommended to use metal cookware as it will arc, which can lead to fire.
Plastic/ polystyrene e.g fast food containers	✓	Care must be taken as some containers warp, melt or discolour at high temperatures.
Cling film	✓	It should not touch the food and must be pierced to let steam escape.
Freezer/roasting bags	✓	Must be pierced to let steam escape. Ensure bags are suitable for microwave use.
Paper plates cups and kitchen paper	✓	Do not use plastic or metal ties, as they may melt or catch fire due to the metal arcing.
Straw and wooden containers	✓	Only use for warming or to absorb moisture. Care must be taken as overheating can cause fire.
Recycled paper and newspaper	x	Always attend the oven when using these materials as overheating may cause fire. May contain extracts of metal which will cause arcing and may lead to fire.



When heating food in plastic or paper containers, monitor the oven due to the possibility of ignition.

TROUBLESHOOTING CHART

Query	Answer
Draught circulates around the door	When the oven is working, air circulates within the cavity. The door does not form an airtight seal so air may escape from the door.
Condensation forms in the oven, and may drip from the door	The oven cavity will normally be colder than the food being cooked, and so steam produced when cooking will condense on the colder surface. The amount of steam produced depends on the water content of the food being cooked. Some foods, such as potatoes, have a high moisture content. Condensation trapped in the door glass should clear after a few hours.
Flashing or arcing from within the cavity when cooking	Arcing will occur when a metallic object comes into close proximity to the oven cavity during cooking. This may possibly roughen the surface of the cavity, but would not otherwise damage the oven.
Arcing potatoes	Ensure all "eyes" are removed from the potatoes and that they have been pierced, place directly onto the turntable or in a heat resistant flan dish or similar.
The display is lit but the control panel will not work when pressed	Check that the door is closed properly.
Oven cooks too slowly	Ensure correct power level has been selected.
Oven makes a noise	The microwave energy pulses ON and OFF during cooking/defrosting.
Outer cabinet is hot	The cabinet may become warm to the touch - keep children away.

Dometic Refrigerator Model RMS8550/ RMSL8500



Winter Operation: Please check that the ventilation grilles or the flue outlets are not blocked by snow, leaves etc.

Cleaning

Before starting up the refrigerator, it is recommended to clean inside and repeat this at regular intervals. Use a soft cloth and lukewarm water with a mild detergent. Then wipe out the appliance with clean water and dry thoroughly.



To avoid deterioration of materials: Do not use soap or hard, abrasive or soda-based cleaning agents. Do not allow the door seal to come into contact with oil or grease.

Operating modes and use of the refrigerator:



This refrigerator is equipped to operate on three power modes: AC mains power (230V). 12V DC or gas (propane/butane liquid gas).

Select the desired power mode by the energy selector switch.

The cooling unit is silent in operation.

The refrigerator works reliably on slopes of up to 6° (5° with models starting from 140 litres capacity).

When the appliance is started for the first time, there may be a mild odour which will disappear after a few hours. Air the living space thoroughly.

The refrigerator will take several hours

to reach its operating temperature in the cooling compartment.

Control Elements Of Energy Selections (BATTERY IGNITER)



A= Power On switch/ Energy selector switch

B= Temperature selection

C= Manual igniter (battery igniter)

D= Gas operation indicator

Explanation

The refrigerator is equipped to operate on mains power, 12v DC or liquefied gas. Select the desired power supply by turning the energy selector switch A. The energy selector switch A has four settings: OFF, AC mains voltage, DC (battery) and gas.

FITTED EQUIPMENT - Refrigerators

Electrical operation

Appliances with battery igniter

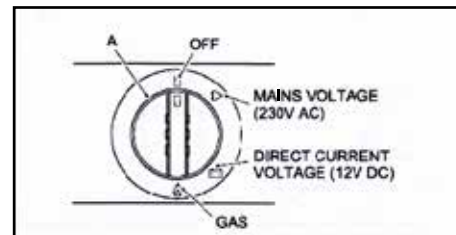

Switch on the appliance by turning the energy selection switch A clockwise to position:



230v Operation



12v Operation



In order to prevent discharge of the on-board battery, 12v operation should only be used while the car is running.

Gas Operation (Liquid Gas)



The refrigerator must be operated using liquefied gas (propane or butane NOT natural gas or town gas). When using LPG please consider that the burner needs cleaning at shorter intervals due to the gas combustion method (annually).

For physical reasons, ignition faults could occur starting from an altitude above sea level of approx. 1,000m/3,280 ft. (This is not a malfunction!)

FITTED EQUIPMENT - Refrigerators

On the initial refrigerator start-up or after a cylinder change, air may be trapped in the gas line. To purge the air from the line, switch on the refrigerator and any other gas appliances (e.g. stove) for a short time. The gas ignites without delay.

As a basic rule, gas operation is prohibited in petrol stations.

Prior to starting the refrigerator in gas mode:

- Open the gas cylinder valve.
- Open the shut-off valve for gas supply to the refrigerator.

Appliances with Battery Igniter

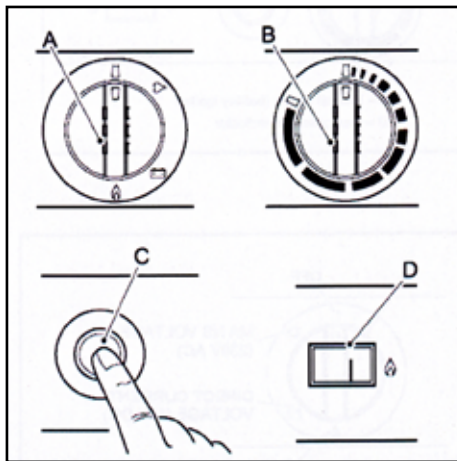

i Each refrigerator with manual ignition is equipped with an automatic flame

safety valve which interrupts the gas supply after approx. 30 seconds when the flame has extinguished.

Door Locking

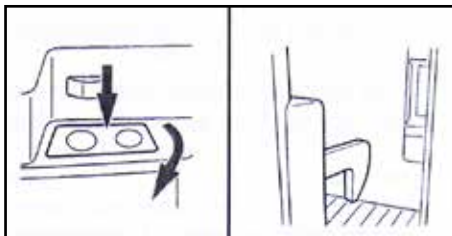

- Open the door by pressing the locking button and pull again.
- Shut the door again by pushing it to close. The snapping into the lock can be heard.

Fixing and releasing the door lock hook when parking the vehicle

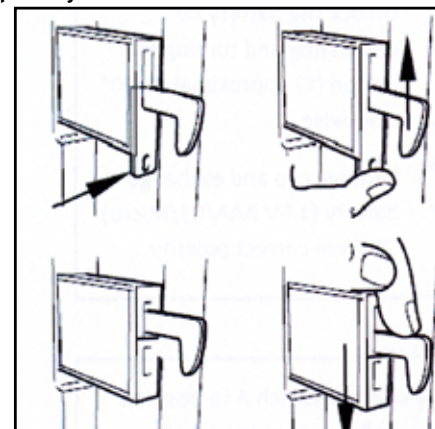

- If the vehicle is parked for a longer period of time, the locking hook may be clamped by means of a lock-bar. The door may now be opened by just pulling it without the need of

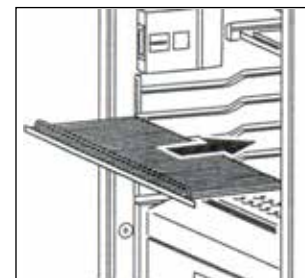

- pressing the locking button.
- Restore the original position by pushing the

hook down.



As a basic rule, shut and lock the refrigerator door before commencing your journey.

Removable freezer compartment

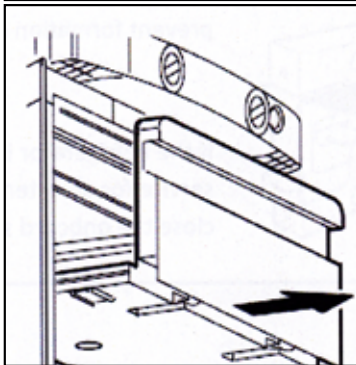
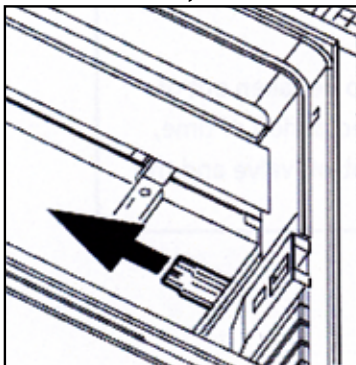

- To enlarge the cooling space just remove the freezer compartment.

- Unlock the freezer compartment on both sides and pull it out.
- Store the freezer compartment safely in order to prevent damage.

Positioning the storage racks

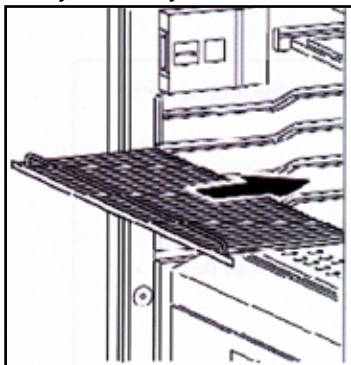

- The storage racks may be pulled out by smoothly lifting them and may be positioned as desired.



Once the freezer compartment is removed, an additional storage rack may be installed. The storage rack is a piece of extra equipment and may be obtained from Dometic.

FITTED EQUIPMENT - Refrigerators

Exchange of the igniter's battery

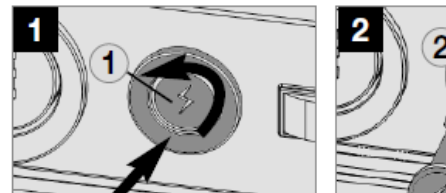

- Unlock the battery by depressing and turning the button (C) approximately 90° Anti-Clockwise.
- Remove cap and exchange battery (1.5V AAA/R3/Micro). Observe correct polarity.

Shutting off the refrigerator

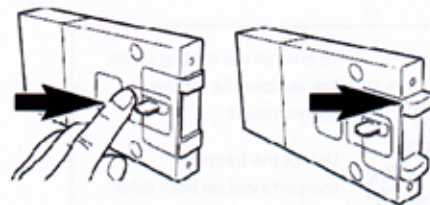
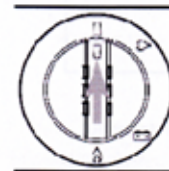

- Set energy selector switch A to position OFF. The appliance is switched off.
- Release the locking mechanism of the door lock by pushing it and shift it to the front.

FITTEDEQUIPMENT - Refrigerators

If the door is shut in this position, a small gap is nevertheless kept open to prevent formation of mildew.

- If the refrigerator is to be taken out of service for an extended period of time, close the on-board shut-off valve and the door.

Lighting

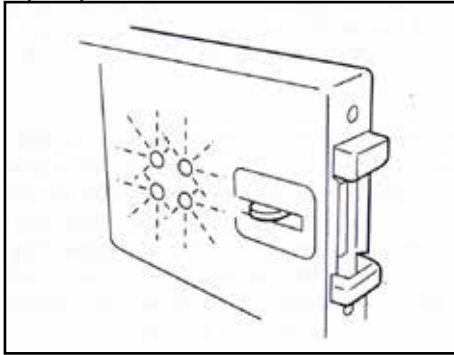

- If the door is open for more than two minutes, the sensor-controlled interior lighting is automatically cut off (except for models with battery igniter).

Maintenance

Please visit:

www.dometicapproved.co.uk

or telephone:

+44 (0) 844 6260130

to locate your local service centre. Installation may only be carried out by authorised personnel. We recommend contacting your Dometic Service Centre.

EN 1949 stipulates that the appliance's gas equipment and its associated fume system must be inspected after installation and a certificate issued.

When using the fridge for extended periods on gas operation Dometic recommend a seasonal service is carried out by authorised personnel.

It is the user's responsibility to arrange for inspections after purchase.

It is recommended that the gas burner be inspected and cleaned as necessary at least once a year.

We also recommend maintenance following an extended shutdown of the vehicle.

THE THETFORD C262 TOILET

Introduction

The Thetford Cassette Toilet is a high quality product. The toilet forms an integral part of your motorhome bathroom, thanks to its functional design which combines modern styling and ease of use.

The C-262 Cassette Toilet is manufactured from high quality synthetic materials which makes it a durable, user and maintenance friendly toilet.

The toilet is made up of two parts: a permanently fixed part and a waste holding tank that is accessible from the outside. The removable waste holding tank is located under the toilet bowl and can be removed via a door on the outside of the motorhome.

The operating instructions cover Thetford Cassette Toilet C262 CWE.



Parts

1. Cover
2. Seat
3. Swivelling toilet bowl
4. Blade handle to open and close blade
5. Control panel
- 5b. Waste holding tank level indicator
6. Pull handle
7. Pour out spout
8. Cap with measuring cup
9. Automatic pressure release vent
10. Vent button
11. Sliding cover
12. Blade opener
13. Waste holding tank mechanism
14. Wheel
15. Service door
16. Water fill door

17. Console with flush water tank
18. Filter for electric ventilator
19. Location waste pump-out system

Preparing for use (standard)

- Open the access door on the outside of your motorhome.
- Remove the waste holding tank by pulling the safety catch (which holds the tank in place) upwards.
- Pull the waste holding tank outward to the stop. Tip it slightly and take the tank fully out.
- Place the tank upright and turn the rotating emptying spout upwards. The emptying spout ensures that the tank can be easily and hygienically emptied.
- Remove the cap, with the measuring cup inside, from the emptying spout and pour the correct dosage of Thetford toilet fluid (see product label) into the holding tank. This avoids unpleasant smells and keeps the inside of the tank clean. Next add approximately 2 litres of water - enough to ensure that the bottom of the waste holding tank is covered. Screw the cap back onto the emptying spout and turn back to its original position. The emptying spout measuring cup is supplied inside the toilet. Never add toilet fluid directly via the blade or the toilet bowl as this could damage the lip seal of the waste holding tank. Always pour the fluids via the emptying spout. The lip seal is the water tight seal around the top of the tank.
- Slide the waste holding tank back into its original position via the access door. Make sure that it is secured with the safety catch.

FITTED EQUIPMENT - THETFORD C262 TOILET

Close the access door and lock it. Your Thetford toilet is now ready to use.

- Never use force if you cannot get the tank back into place easily. This may cause serious damage. If blockage occurs, always check that the blade handle is in the correct position.
- For toilets with own flush-water tank: open the water filling door and fill the flush-water tank with the correct dosage of Aqua Rinse. This Thetford toilet fluid keeps the flush water fresh and improves the flushing. Next, fill up the flush-water tank with clean water (approximately 8 litres) using a watering can or hose. Your toilet is now ready to use.

Using the toilet (standard)

- Turn the bowl to the desired position with the lid closed and using both hands.
- To activate the control panel, press the flush-button once. The control panel display will stay activated for approximately 5 minutes. Run some water into the bowl by pressing the flush button again briefly.
- The toilet may be used with the blade open or closed. To open the blade, slide the blade handle under the toilet bowl sideways. After use, open the blade (if still closed) and flush the toilet by pressing the flush button for several seconds (if necessary re-activate the control panel). Close the blade after use. If your toilet has its own flush-water tank, please make sure that you do not travel with a flush-water tank that is too full. Do not travel with water in the toilet bowl. Failure to adhere to this notice may result in water damage to your motorhome.

Emptying

- The waste holding tank has a capacity of 18 litres and requires emptying when the red light (LED) on the toilet control display lights up. At that point the waste holding tank only has capacity for two more litres which is no more than two to three further uses.
- Place the waste holding tank in an upright position (pull-out handle at the top, wheels at the bottom). slide the handle sideways – to the front of the tank – until it snaps out of its locked position. Pull the handle up and wheel the waste holding tank to an authorised waste disposal point. Push the handle back into its locked position. Turn the emptying spout upwards and remove the cap from the spout. Hold the waste holding tank in such a way that during emptying you can operate the vent plunger with your thumb. To empty the tank without splashing, depress the vent plunger while emptying the tank. After emptying, rinse the tank and blade thoroughly with water.
- Do not vigorously shake the tank or use high pressure water cleaners. This may cause damage to the tank's interior.
- The vent plunger should only be depressed once the emptying spout is pointing downwards. Prepare the toilet for re-use if required. Slide the waste holding tank into the toilet and close the access door.

Emptying with Optional Features

- Waste holding tank multi-level indicator: The lower lamp indicates that the waste holding tank is almost empty; the middle lamp indicates that it is more than half full;

when the upper lamp lights up, the tank needs emptying as it can only take two to three further uses.

- The waste holding tank level Indicator will flash when the holding tank is not present. In this case the toilet will not flush.

Cleaning and Maintenance

- The toilet should be cleaned and maintained regularly, depending on the amount of use. To clean Thetford toilets, we advise using water and Thetford Bathroom Cleaner. Never use bleach, vinegar or other powerful household cleaners that contain these substances. These may cause permanent damage to the seals and other toilet components.

Motorhome Equipment

Toilet Bowl

- Squirt Thetford Bathroom Cleaner into the toilet bowl.
- Flush the toilet bowl with water and wipe down the rest of the toilet with a damp cloth.
- Clean seat and lid. The seat and lid can easily be removed: lift the seat and lid assembly and pull the round pins (inside the assembly) outwards from the pin holes. After cleaning, replace the seat and lid by positioning the round pins in front of the pin holes and push the lid and seat downwards.
- To keep your flush water fresh and to prevent deposits forming in your toilet bowl, add a correct dosage of Aqua Rinse in your flush-water tank.
- Tip! For a really shining toilet, dry with a soft dry cloth after cleaning.

Waste Holding Tank

To keep your waste holding tank fresh and clean, Thetford has developed a number of different toilet fluids. Thetford toilet fluids suppress smells, reduce formation of gas, promote breakdown of toilet waste and increase the life span of a mobile toilet. We advise a thorough cleaning of the waste holding tank once each season.

Next to using Thetford's Cassette Tank Cleaner, which is the powerful cleaning agent for the periodical cleaning of the waste holding tank of your toilet we suggest the following.

- Remove the removable mechanism from the waste holding tank by turning it anti-clockwise and rinse it under a tap.
- Remove the cover plate from the automatic pressure release vent by prising it up using a small screwdriver. Use one hand to push the automatic pressure release vent open while holding the float of the automatic pressure release vent on the inside of the tank with the other hand. Push the float upwards, turn it 180° and remove it from below. Remove the rubber seal underneath the float. Rinse the float and rubber seal under a tap. Replace the rubber seal and float for the automatic pressure release vent using the same method in reverse.
- The rubber seals in the toilet (the lip seal, the mechanism seal, the automatic pressure release vent seal and the cap seal) should be regularly cleaned with water and treated with Thetford High Grade Seal Lubricant. This will ensure that the seals remain flexible and in good condition. If the toilet is not to be used for any length of

time, it is important to treat the seals with Thetford High Grade Seal Lubricant after cleaning.

- Never use Vaseline or any vegetable oil except olive oil. These may cause leakage or malfunction. The lip seal is a part of the toilet that is subject to wear. Depending upon the extent and manner of use, the seals will become less effective and will need replacing periodically.

Winter operation

You can use your Thetford Cassette Toilet as normal in cold weather as long as the toilet is situated in a heated location. If there is a risk of freezing we advise that the toilet is drained. For environmental reasons the use of antifreeze, such as that used in car radiators, is not recommended.

FITTED EQUIPMENT - THE DROP DOWN BED

Some models in the range are fitted with electronic drop down beds.



These beds are designed and tested to support up to and not exceeding 200kg.

Due to the mechanism it is important that the following are adhered to:

Do not remain on the bed while the lifting mechanism is in use.

Do not allow others or children to remain on the bed while the lifting mechanism is in use.

Do not allow children to play with the lifting mechanism.

Ensure that the running track of the lifting mechanism is kept clear.

When lifting or lowering the bed remove all bedding, except for the fitted sheet.

Before lifting the bed raise the mattress and store the fall out nets in the gap by the Froli springs.

The bed is operated from a small aluminium panel with security key and two buttons, one to move the plane of the bed upwards, the other downwards.

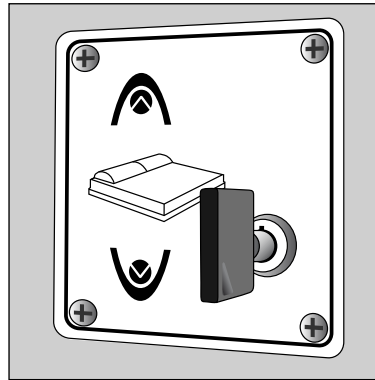

OPERATION

Insert the key into the lock and turn clockwise by 90°.

Press the top button to bring up the bed. The bed moves as long as the button is pressed to lift.

Press the bottom button to lower the bed. The bed moves downward as long as the user holds down the button.

The lifting-bed system is equipped with two limit switches for protection. If for example the user depresses and holds the down button for a longer time than that required for the bed to travel its full drop, a protection device takes over and disables the movement so as not to exit the bed from the guides and also to protect the motor.

This protection is replicated for the upward movement.

Once the bed reaches the desired position, turn the key to the OFF position, turning it to the left by 90°.

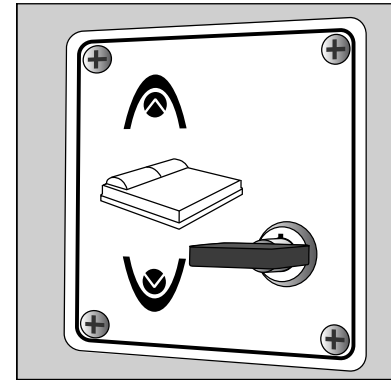

PROTECTION

There are various types of protection.

- * The key for isolation of operation.
- * 2 limit switches, one high and the other low
- * Mechanical movement.

The bed-lifting mechanism should only be operated by adults.

EMERGENCIES

Unlocking procedure in case of insufficient power.

The electric motor is fitted on the end with a hexagonal nut, which allows manual movement of the plane of the bed in case of insufficient voltage of the vehicle leisure battery. The bed mechanism can be operated manually, if power is disabled, simply by turning the hexagonal nut clockwise or counter-clockwise, depending on the desired direction of movement.

Ecocamel Shower Head

Your motorhome is fitted with an Ecocamel shower head.

- It saves water, energy and money.
- It has a wipe clean head to prevent the build-up of lime scale.
- Uses a maximum of 8 litres a minute .

After showering, when the shower is turned off, your Ecocamel shower head simply drains off any excess water through the air intake.

Clean your Ecocamel shower head with a damp cloth. Do not use any abrasive or chemical cleaners. Should any scale build up on your shower head's spray plate you can de-scale it by rubbing the nozzles with your thumb.

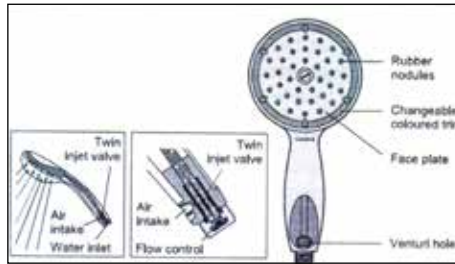

Bathroom Shower Tap

Your shower tap has a high quality finish and should be treated with care to preserve the visible surfaces.

All surface finishes will wear if not cleaned correctly; the only safe way to clean your mixer is to wipe with a soft damp cloth.

Stains can be removed using washing up liquid.

All bathing powders and liquids will damage the surface of your fitting, even the non-scratch cleaners.

Mirrors

Cleaning

- It is best to clean mirrors with a cleaner that does not contain ammonia. If you are not sure of the ingredients, spray a clean lint free cloth with the cleaner so as not to get the liquid near to the edge of the mirror which is where ammonia would cause the most harm.
- Use a soft, dust free cloth.
- Warm water- try bottled water if your tap is mineral rich.
- For stubborn dirt use an oil free steel wool pad - carefully and precisely.
- Spray cleaners on your cloth, not directly onto the mirror.
- Keep the mirror frame dry.
- Never use a razor blade on a mirror, even if the mirror has paint specks on it. Always use hot water first.
- If you find black spots on your mirror you may have damaged the silvering behind the mirror's glass. If this is the case you may be able to cover the spots from the front.
- Moisture along a mirror's edge can seep in and harm the reflective backing.
- Keep in mind that long-term exposure to sunlight may damage some mirrors.

FITTED EQUIPMENT - WINDOW BLINDS

Remis Remibase Plus Window Blinds

Please note the blinds should not be in the closed position when the vehicle is travelling or when in storage for extended periods.

The sun screen is housed at the bottom and the fly screen at the top of the blind. To open either hold the cross bar and pull up or down. Both blinds can be fully extended to totally cover the window or can meet at any position to give sun shading/privacy and protection from insects entering the vehicle.

The blinds are pre-set to the correct tension. If re-tensioning is required please follow these steps:

The blind needs to be taken down from the wall by unscrewing the 4 corner screws.

Lay the blind face down on a table with the cross bars of both blinds meeting in the middle. The black cords re-tension the fly screen and the white cords re-tension the sun screen.

The cords are fixed at either side with a screw. Loosen this screw and gently pull the cord 5mm tighter and repeat on the other side ensuring the cross bar is level.

Test the tension. This process can be repeated if necessary.

The blinds over the kitchen sink and in the bathroom are of a different construction and can be re-tensioned while fixed to the wall. On the side of the cassettes are two plastic screw

heads. Using a screwdriver turn these gently clockwise until the correct tension is reached. Test the tension after each turn.

Cleaning

The actual plastic profiles can be cleaned with a non-abrasive cleaner and damp soft cloth. The blinds should only be dusted lightly with a soft cloth.

The blinds over the kitchen sink and in the bathroom have a special sun screen that can be cleaned with a non-abrasive cleaner and damp cloth. The fly screens should only be dusted with a soft cloth.

Remis Concertina Cab Blinds

Remis concertina blinds are fitted to the front windscreen and side windows in the cab of your motorhome. Bailey has chosen to fit these blinds to ensure that when you are sleeping in your vehicle you are not disturbed by the outside light.

Due to the nature and angles that these blinds inhabit it is important that they are opened and closed in the correct manner.

Usage of the front system

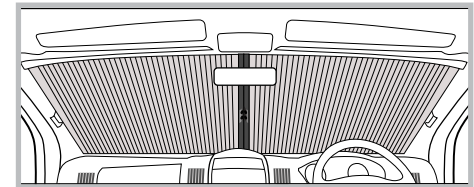
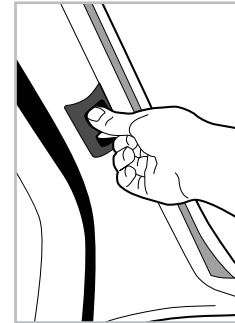

To release the front blinds, push both buttons in the directions of the arrow. Pull handle from the left and right towards the middle of the windscreen. The handles will lock automatically due to the magnetic catch. To open, pull the handles apart in the direction of the arrows and pull them back to their resting position. Lock the handle in place by pushing it into the frame.

 Always ensure that both sides are locked in place prior to commencing travel.

 Do not swing your forward visors to the driver or passenger door as this will damage the blinds.

Usage of the side system

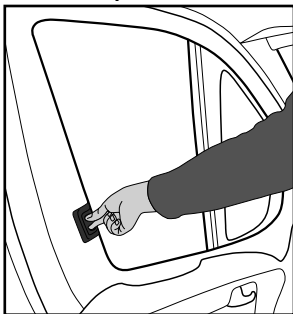

Closing

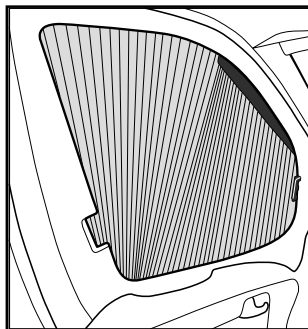
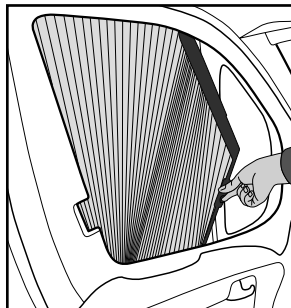

Release the handle by pushing and pulling slightly from its resting position. Pull the handle to the catch, the magnetic catch will lock automatically.

Opening

Pull handle to catch. Lock handle in place by pushing on the frame

FITTED EQUIPMENT - WINDOW BLINDS



Always ensure that both sides are locked in place prior to commencing travel.



Do not swing your forward visors to the driver or passenger door as this will damage the blinds.

Cleaning of Remis Cab Blinds

- Avoid using aggressive cleaning agents (solvents/abrasives).
- Clean the frame elements of the front and side systems with a damp cloth and mild soap solution.
- Clean the folding material carefully with a soft brush or damp cloth.

The Approach Advance Range is not fitted with side mounted blinds as an alternative these have thermoliner

LAMILUX COMPOSITES

Fibre-reinforced composites - the high-tech material for roofs, walls and floors

Long lasting, very light and strong, especially resistant to damage from hail and minor impacts, whilst also being resistant against corrosion. Fibre reinforced composites are the ideal facing sheets for the sandwich panel

elements used in the construction of all areas of caravans and RVs, whether the external or internal walls, floor or roof - fibre reinforced composites from Lamilux are technical and visual highlights.



LAMILUX GRAPH
for the inner wall

LAMILUX HG 4000
for the outside wall



LAMILUX SUPER PLUS MATT
for the inner wall



All tests certified in compliance
with TÜV Süd quality

TUV SÜD certified quality



www.lamilux.com

GRP PANELS

GRP components need to be washed, waxed and cared for like a car. Chemicals and dirt can collect during storage, and the outer surface called a gel coat can be stained or marked when chemicals combine with rain or dew. Most stains or marks can be removed with mild dish-washing detergent, but more stubborn marks may require a rubbing compound. To help keep your GRP components looking almost like new, it is wise to wash the parts monthly (or more frequently) using mild dish-washing detergent, but avoid using strong alkaline (e.g. tri-sodium phosphate) or acidic cleaners or abrasives. Waxing the components once or twice a year with a good grade paste wax will help to maintain the colour and finish.

Insulation

Your Bailey motorhome is insulated with polystyrene which is a material with high insulation qualities. This is used in the construction of the floor, sides, rear panel and ceiling and contributes greatly to the insulation properties that allow the vehicle to achieve grade 3.

RUNNING LIGHTS

- It is important that all the road lights on your Bailey motorhome are checked before you set out on a journey.
- All lights must be working in the correct manner for the vehicle to be road legal.
- Clean the outside of the lights with a non-abrasive or non-aggressive cleaning solution.
- Always replace a lamp which is showing any sign of damage.

FITTED EQUIPMENT - GENERAL

POLYPLASTIC WINDOWS

To open the windows turn the knobs anti-clockwise and open the catches. Swivel the window pane open to the desired position and close knobs clockwise to lock into the open position.

To close, reverse this operation.

All opening windows have two catch positions. The first position is for ventilation while the second seals the window from wind and rain.

ROOFLIGHTS
MPK ROOFLIGHT

The MPK rooflight is situated in the bathroom of your motorhome over the shower compartment.

It is fitted with a fly screen for your comfort. The fly screen is hinged allowing you access to the handles that enable you to raise the rooflight's dome for ventilation.

To raise the dome pinch the black parts of the handle against the other half on both sides and push upwards. Both sides can be raised or just one depending on your preference.

Mini and Midi HEKI Rooflights

Opening and closing the dome

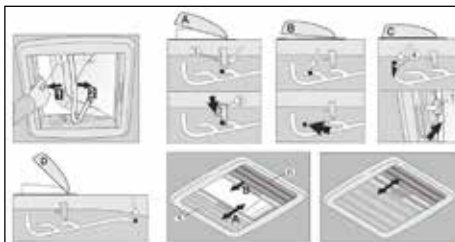

- Press the push button (1) and simultaneously open the dome with the bar (2).
- POSITION "A"
- Push the bar (2) to the marked rest position (•).
- Fix the bar in this position by pushing the left and right sliding catches (3) downwards.
- POSITION "B"
- Push the bar (2) to the marked rest position (•) and lead over the left and right locking mechanisms by applying slight pressure.
- POSITION "C"
- Push the bar (2) to the marked rest position (•).
- Applying slight pressure lead the bar (2) over the left and right catch hooks (4) so that the dome is locked and the bar (2) lies on the push button (1).
- POSITION "D"
- Push the bar (2) to the marked rest position (•).

OPERATING THE BLIND

- Push the blind (5) in the direction of the arrow (A) and the fly screen (6) in the direction of the arrow (B).

Safety instructions

- Do not stand on the acrylic glass.
- Close HEKI completely before moving the vehicle.
- Close HEKI when leaving the vehicle.
- Please consult your dealer when any defects or problems occur.
- Remove snow/ice or other dirt from the roof before opening HEKI.
- Do not open in strong winds or heavy rain.

Care instructions

- Please clean the acrylic panes with the Seitz Acrylic Cleaner.
- Stains and light scratches on the acrylic pane can be removed using the Seitz Acrylic Polish and Seitz special polishing cloth.
- Only use water and mild soap suds to clean the blinds.
- Failure to comply with these instructions makes the guarantee null and void.

STAINLESS STEEL SINK

Stainless steel sinks need little maintenance other than cleaning immediately after use. Most deposits can be removed by washing with soap or mild detergent and hot water, followed by a clean water rinse and drying with a soft cloth to prevent water spotting.

For more tenacious deposits a non-abrasive multi-purpose cream cleaner such as CIF should be used, followed by a clean water rinse and drying.

Tannin stains can be removed by a solution of washing soda and water applied with a soft cloth/sponge followed by a clean water rinse to remove any residues and drying with a soft cloth.

(When cleaning with anything other than water be careful not to get the solution onto your kitchen worktop.)

Scratching will be most noticeable on highly polished components. These marks are usually only superficial and can be removed with a proprietary stainless steel cleaner/polish. A useful alternative is a car paint restorer, such as "T-Cut". If the surface has a directional polished grain always clean along the grain and not across it.

Always avoid bleach and trigger dispense products and never use wire wool or leave wet cloths, pads or containers on the surface as they may form water marks.



To preserve the appearance of your appliance we recommend plastic bowls or mats are not stored in the sink. This is particularly the case when travelling because vehicle movement may cause the plastic bowl to vibrate/rub against the surface and leave marks.

FITTED EQUIPMENT - GENERAL

TECNOFORM DOORS AND WORKTOPS

Wipe the doors with a soft, slightly damp cloth (not wet) and then dry them with a dry cloth. Worktops can be wiped with a wet cloth and are more resistant to water than the locker doors.

Gasoline, benzene, thinners, any abrasive products, chemically treated dust cloths and detergents may damage the doors and should not be used.

FITTED EQUIPMENT - GENERAL

JVC SPEAKERS

The speakers supplied within the habitation compartment of your motorhome are JVC Stereo speakers and should be cleaned with a soft cloth and the outer surface wiped gently. DO NOT APPLY ANY SOLVENT TO THE SPEAKERS.

CARPET

Cleaning and Caring for Carpet Sets

- When cleaning the interior of your motorhome please remove the carpet from the vehicle.
- Vacuum the carpets to take the dirt out of the pile.
- For general cleaning use a dry shampoo, following the product's directions.
- For stains, use a mixture of 1/3 bleach to 2/3 warm water. Immerse a soft cloth in the solution until wet, then wring and squeeze the cloth until damp. Rub the affected area until the stain has gone.
- NEVER USE DRIPPING WATER
- The proportion of water to bleach must be accurate.
- Never put the carpet in a washing machine or a tumble dryer.

TAPS

To clean, wipe with a soft soapy sponge, then rinse and wipe dry. Do not use an abrasive cleaner, scouring pad, powder or wire wool to clean the tap and shower mixer. Do not use any de-scaling agent.



If you live in a hard water area, limescale may build up around the spout of your tap. Clean this off with either lemon juice or vinegar. Do not attempt to remove this with either a knife or any other sharp implement as this will damage the surface.

UPHOLSTERY

General

The Approach models are designed as 2, 4 and 6 berths offering multiple bed layouts and sleeping arrangements. Sometimes the bed make-up utilises the cab seats: other times the beds are made separately.

Cab Seats

The reclining cab seats have full forward and rearward movement by releasing the catch on the front of the seat and sliding it to the required position. Both front cab seats have a swivel mechanism fitted as standard and have dual armrests for your comfort.

Seating Upholstery

The majority of cushions in your motorhome are fully sprung to supply more comfort to both you and your passengers.

The cushions that are not sprung are made from high quality foam providing support and comfort.

Care should be taken of these springs by not loading weight on one area of a cushion for a prolonged period of time when travelling or when the vehicle is in storage. This could lead to the springs failing and the comfort of the cushion being diminished.

The Bailey DE-LUXE mattress features a deep, fully framed sprung unit of domestic quality construction giving "An at home night's sleep while away in your motorhome".

Remove dust on a regular basis with your vacuum's upholstery or drape attachment. Try to avoid brushing fabric covers because that can damage the pile.

- If you spill something on your upholstery, blot up the excess immediately. Avoid detergents which may damage the fabric's protection. Use a sponge or a clean white cloth but do not wash or rub the fabric.
- Try to keep your cushions away from direct sunlight.
- Light affects the colour of fabrics so avoid over-exposure to sunlight.
- Try not to leave newspapers lying on your cushions; ink can stain the covers. It isn't always easy to prevent that from happening; however, proper ventilation can help.
- Try to keep pets off the upholstery and be careful of sharp objects such as belt buckles, toys and watch straps snagging the fabric. If snags do occur, carefully cut off the loose ends with scissors or tuck back in - do not pull them under any circumstances.

Curtains

It is recommended that the curtains in your motorhome are washed on a delicate cycle at 30°C. This will not damage the clip glides. Shrinkage may be caused should you decide to dry clean your curtains.

FITTED EQUIPMENT - GENERAL

Safety

Passengers are reminded that it is a legal requirement to wear the seat belts provided while the vehicle is in motion.

Table

When not required, the table should be securely stored in the table store. When the table is needed, its legs should be folded out and the table placed where required.

The side dinette table and table leg should always be stored while travelling in the dedicated storage.

Ensure the folding legs are locked in place before using the table. The table must be stored when the vehicle is in motion.

NOISE VIBRATION AND HARSHNESS

Noise Vibration and Harshness (NVH)

During the development of the Approach range of motorhomes Bailey determined that a quieter journey adds to your comfort as a traveller. The team developed stringent requirements relating to Noise Vibration and Harshness (noise emissions from your empty vehicle). During the test drives the team identified items that were making noise and where possible designed solutions which are enforced during the build procedure or rectified by the component suppliers.

Bailey has fitted bump stops to all cupboards and drawer fronts. Should you lose a bump stop or require extra these are readily available through the Bailey Parts website. When fitted they will make your journey a more comfortable one.

High density acoustic foam has been used in the construction of the vehicle to eliminate the noise.

You may find that closing rooflight blinds during transit also helps to eliminate noise.

Thetford Linear Hob

The glass lid that covers the hob is fitted with bump stops which prevent the glass from rattling on the trivet. These bump stops may, with time and driving on uneven road surfaces, move from the ideal position. If you find that your hob rattles on the trivet we would first advise you to move the bump stops to the correct position. Failing this we would advise that you position a tea towel under the glass lid while driving.

Please ensure that you remove the tea towel before you commence cooking.

Thetford Grill Pan

The Thetford grill pan is loose in the grill box and therefore during transit can move around and make an irritating noise. To avoid this, Bailey would advise that the grill pan is stored in the pan storage compartment at the bottom of the oven and wrapped in a tea Towel.

Polyplastic Windows

The window stays on your motorhome have a tendency to rattle. Should you encounter this we would suggest that you open each window that is rattling and tighten the stay so that the window stays open, then loosen the stay by 1/2 of a turn. The window stay will still be under tension but you should be able to push it closed easily. Turn the catches to secure the window tight.

This operation must not be undertaken when the vehicle is in motion.

Remis Cab Blinds

If the cab blinds have been knocked out of their fixing points they will rattle. If you experience this during transit please return your vehicle to your retailer and ask them to refit the blinds.

make it
your own...



Alfie (New Forest)



CGI

01234 846 000 

www.cgi-visual.com 

customise@cgi-visual.com 

More comfort on the move



Truma Aventa Comfort Roof Air Conditioning System

With maximum efficiency in heating and cooling operations

Fast and easy installation. Can be retro-fitted in existing standard skylight cut-out.

Truma Aventa Comfort

Specified as standard on
Bailey Unicorn 3 caravans
supplied to Australia.



Truma SolarSets

Maximum Efficiency and Safety

The freedom to generate your own
energy anytime, anywhere.

Specified as standard on all
Bailey Unicorn 3 caravans.

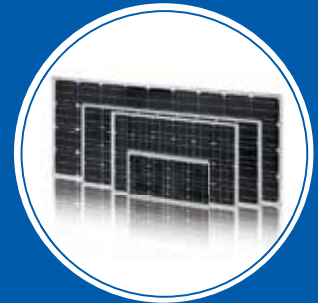

Contact your nearest dealer for more
information on our extensive product range
or call **01283 586050**. www.trumauk.com

 **truma**
More comfort on the move

Care and Maintenance of your Motorhome

Exterior

The exterior of your motorhome is very durable and easy to clean owing to its high gloss properties. To maintain a showroom finish, one needs only to wash the motorhome and the parts monthly (or more frequently) using Care-avan* Motorhome Cleaner, but avoid using strong alkaline (e.g. tri-sodium phosphate) or acidic cleaners or abrasives. Waxing the components once or twice a year with a good grade paste wax will help to maintain the colour and finish.

Cleaning / usage information

- Wash the motorhome by hand, using a sponge with plenty of Care-avan* cleaning solutions to avoid scratching.

* Available through your supplying Bailey retailer or available to order direct via our Parts Direct website

- www.bailey-parts.co.uk

- Always rinse away any cleaner from your motorhome.
- Dry the vehicle with a chamois or a microfibre cloth.
- It is imperative to ensure that the area surrounding the rooflight is completely dried; this will avoid both condensation and damp collecting around the perimeter.
- Where possible position the vehicle nose down for a short period to avoid water pooling and collecting on the roof area.

Do not

- Do not apply a carnauba-based wax to the vehicle.

- Do not use a mechanical brush washing system such as a car wash.
- Never pressure wash your vehicle.
- Do not use solvents.
- Do not use acrylic cleaners.



Under no circumstances use any abrasive agents, methylated spirit, white spirit or other solvents to the exterior of your motorhome.

No touch up painting should be carried out prior to consulting with a Bailey Service Centre for approved methods.



All items stored in the gas bottle storage locker must be secured to prevent impact damage to the inside of the body panel when the vehicle is in motion.

Do not allow any chemicals, toilet or otherwise, to spill or leak into the gas box floor. Before placing items in the cradle ensure that the tray is clean and free from any debris. Cleaning should only be carried out with warm soapy water.

The use of high pressure water jets to clean your motorhome will invalidate your warranty.

GENERAL CARE AND MAINTENANCE

Acrylic Windows

The windows fitted to your motorhome are manufactured from high quality acrylic using the latest plastic processing methods.

For cleaning, use only generous amounts of water to wash away dust and road grit etc. Then use a soft cloth and warm soapy water and gently remove the remaining dirt. Avoid abrasive cleaning materials and detergents. As with all plastic materials, acrylic should not be allowed to come into contact with chemicals such as paint remover, fly spray, acetone, dish washer detergent and car cleaning detergent.



Never polish with a dry cloth. During high sun do not close the window blinds completely and open the windows into the ventilation position. While the vehicle is in motion please ensure that the windows are fully closed (this information is also detailed on stickers on the windows).

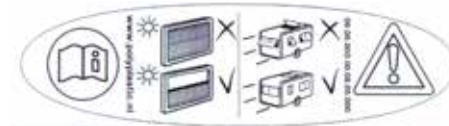

GENERAL CARE AND MAINTENANCE

Winterisation/Storage

The following applies whenever your motorhome is stored, particularly during winter months.

- If you will not be using your vehicle for a while it is probably a good time to arrange for your motorhome to have its annual service at your appointed dealer.
- Do not leave your vehicle near trees or latch-type gates due to possible wind damage.
- Keep any grass around the floor of the motorhome short to maintain airflow and stop any possible damp getting into it.
- It is advised that the motorhome is ventilated regularly throughout the winterisation/storage period, opening windows, doors and rooflights where possible.
- All moving parts should be checked for free operation.
- Clean all cooking appliances and the refrigerator before parking up the vehicle.
- Charge up the on-board battery every 2 months.
- Leave the refrigerator door open. Leave the furniture and locker doors open to allow air to circulate fully.
- Ensure that the entire water system is thoroughly drained.

Winterising

Freezing in winter may cause damage to the Whale tap.

To avoid this damage, ensure that the system is completely drained.

- Drain the fresh water tank using either the pump or a drain valve.
- Turn the pump on and open all taps and the shower mixer (including the drain valve) and allow the pump to purge the water from the system.
- Turn off the power isolator switch for the water pump.
- Remember to leave all outlets open to avoid any damage.
- Lift up the lever of every tap and leave it in its central position.

Modifications: DIY work

Owners need to be aware that carrying out DIY modifications to your caravan or motorhome may, in certain circumstances, invalidate the warranty cover and could also affect the safety and structure of the vehicle.

Condensation

What is Condensation?

Condensation is the change of water from its gaseous form (water droplets) into its liquid form.

Condensation generally occurs in the atmosphere when warm air rises, cools and loses its capacity to hold water vapour. As a result, excess water vapour condenses to form droplets.

Condensation normally occurs in the winter when the motorhome is cold and skylights windows and doors are opened less often; this means that moist air cannot escape.

It is important to try and provide ventilation so that moist air can escape; and to use the heating responsibly.

How you can prevent condensation

Provide ventilation so that warm air can escape

- Good ventilation of kitchens when washing, cooking or drying damp cloths is essential, use the electrical element of the heating system, particularly if the windows show signs of misting up.
- If it is not possible to use the space heater open the skylights or windows slightly but keep the main door closed as much as possible.
- After showering, keep the bathroom door closed and the window or the skylight open long enough for the room to dry.
- Prepare your vehicle for cold conditions.

Your motorhome is fully winterised and has achieved the BS EN 1646-1:2004+A1:2008 standard climatic testing to Grade 3 standard.

- Make sure that all plumbing pipes, drains, and water supply appliances within the motorhome are properly drained.
- Remove the battery from the motorhome to keep it warmer. If the battery cells were to freeze this could cause damage to the cells and decrease the life of the battery.
- Try to cover as much as possible of the underside of the motorhome to prevent snow from collecting and packing up underneath. This will help to prevent damage to the tyres due to weather conditions.
- Apply a lubricant to any of the locks to prevent them from freezing up. This will allow you access to your motorhome if it is needed.

GENERAL CARE AND MAINTENANCE

Spares and After-Sales

There are numerous parts and accessories available for your motorhome either from your Bailey retailer or through the Bailey Parts website. You are more than welcome to contact the parts website for anything you may require. However, if it is a safety or warranty critical item you will need to obtain it from your Bailey retailer who will fit the component for you.

GENERAL CARE AND MAINTENANCE

Caring for the Environment

After many years in service you may decide that your motorhome has become beyond economic repair and should be disposed of. Please ensure that you comply with the end-of-life vehicle legislation and take it to an authorised treatment facility where it will be properly dealt with to minimise any negative environmental impact. The transaction will be logged by the DVLA, identifying that you are no longer the owner of the vehicle.

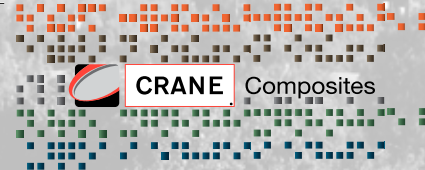

CRANE Composites

**PROUD SUPPLIER OF
WALL & CEILING GRP, GLASS
REINFORCED PLASTIC, PANELS
TO BAILEY OF BRISTOL**



Crane Composites provides Bailey of Bristol with superior wall and ceiling GRP, glass reinforced plastic, panels that enhance your motorhome with the following benefits:

- LIGHTWEIGHT
- COLOR STABILITY
- TOUGH, DURABLE SURFACE
- SMOOTH, MATTE, EASY CLEANABLE SURFACE



CRANE Composites

www.cranecomposites.com

internationalsales@cranecomposites.com

+44 (0) 7973 819372

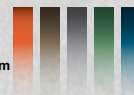

GET A CLEARER VIEW

Did you know that your new Bailey motorhome has pre-installed cabling to fit a WAECO reversing camera?

WAECO Reversing Camera System RVS 550W

- For 12 volt and 24 volt operation
- USB connection for charging MP3 players etc.
- Easylink monitor mount, for easy removal
- LED background illumination
- Colour camera available in white or silver
- 5" colour LCD monitor
- 2 year warranty



For further details please contact your local Bailey dealer

 Dometic

WAECO
by Dometic GROUP

USEFUL CONTACT DETAILS



BAILEY OF BRISTOL	customerservices@baileyofbristol.co.uk	
BAILEY SPARES DEPARTMENT	parts@baileyofbristol.co.uk	
MICHELIN TYRES PLC		+44 (0) 845 366 1535
PEUGEOT ASSISTANCE		+44 (0) 800 294 0294
PEUGEOT ASSISTANCE IN EUROPE		+44 (0) 800 332 2887 7
		+33 825 8789 83
		+33 472 1712 05
AL-KO	mail@al-ko.co.uk	+44 (0) 1926 818 500
FIRE ANGEL TECHNICAL SUPPORT LINE	technicalsupport@fireangel.co.uk	+44 (0) 800 141 2561
TRUMA		+44 (0) 1283 586 020
DOMETIC	technical@dometic.co.uk	+44 (0) 844 626 0130
THE CARAVANS CLUB	www.caravanclub.co.uk	+44 (0) 1342 326 944
THE MOTORCARAVANNERS CLUB	www.motorcaravannersclub.eu	+44 (0) 1684 311 677
THE CAMPING AND CARAVANNING CLUB	www.campingandcaravanningclub.co.uk	+44 (0) 845 1307 631
THE NATIONAL CARAVAN COUNCIL	www.nationalcaravan.co.uk	+44 (0) 1252 318 251
THE BAILEY OWNER'S CLUB	www.baileyownersclub.org	

Roof Air Conditioning from Dometic

The most compact roof air conditioner on the market

Dometic FreshJet 1100, 1700 & 2200

- 3 performance levels for vehicles up to 5m, 6m or 7m in length
- Very low starting currents - FreshJet 2200 with Soft Start
- Air diffuser with four adjustable air flows
- LED lighting, remote control



Vehicle length: 5m, 6m, 7m



FreshJet 2200



For further details please contact your local Bailey dealer
or visit: www.my-caravanning.com

 Dometic





