



GO WITH  
THE NATION'S  
FAVOURITE



## Motorhome Owners Manual

October 2020



*Autograph*



**ALLIANCE**  
*Silver Edition*



**ADAMO**

WELCOME TO  
THE NATION'S  
FAVOURITE





## Welcome to Bailey, The Nation's Favourite

We've been proudly hitting the road for over 70 years. Along the way we've built hundreds of thousands of Bailey caravans and motorhomes, each of them with one thing in mind; creating the perfect holiday.

So, no matter which of our models you have chosen for your home away from home, comfort, convenience and adventure are built into every one.

This manual contains everything you need to know on how to operate your caravan and is also available in a digital format at [baileyofofbristol.co.uk](http://baileyofofbristol.co.uk).

**GO BAILEY!** We can't wait to see you out there.

## Proud Suppliers to Bailey



Belfield Furnishings offers a one-stop shop upholstery and soft furnishings service for the leisure and mobile home sector. You will find our products in touring caravans, motor homes, static caravans and residential lodges. All our upholstery, mattresses and curtains are made to order at our two factories in Derbyshire.

## Contact us to see what we can do for you







The home of Bailey Parts

## The official home of Bailey parts and accessories

Keep your new Bailey motorhome safe, secure and sparkling clean with branded accessories designed for a perfect fit. Look no further than PRIMA Leisure to find everything you need:

- Model-specific products for your new motorhome including the PRIMA air awning range designed for your Bailey.
- Official OEM spare parts and upgrades.
- 20,000+ products available to order online or through your local Bailey retailer.



[www.primaleisure.com](http://www.primaleisure.com)





# *Make a sandcastle*

(or visit a real one)



 Bamburgh Castle near Berwick Seaview Club site  
Northumberland

Join today and save on access to more than 2700 sites across the UK and Europe.

Get away, your way - visit [camc.com/join](https://camc.com/join) or call 01342 488120 to join today.

Join us  
for just  
**£54**  
a year

 **CARAVAN AND  
MOTORHOME CLUB**  
SINCE 1907

# CONTENTS

---

Introduction .....	6
Getting to Know Your Motorhome.....	7
Glossary of Terms.....	10
Safety and Security.....	13
Weight restrictions and loading .....	18
Before Moving Off .....	23
Travelling .....	25
Setting up on arrival .....	31
The Water System.....	35
The Gas System.....	43
The Electrical System .....	50
Solar Dual Battery Charger .....	56
The Heating System.....	62
The Seattle Control Panel.....	87
The Digital Antenna System.....	92
Cooking Equipment .....	96
The Microwave Oven.....	102
The Refrigerator .....	110
Surface Care .....	119
The Thetford C262 Toilet .....	122
Fitted Furniture Configurations.....	127
Roof Lights.....	146
The Window Blinds .....	150
The Thule Awning.....	153
Maintenance.....	156
Warranty .....	163

# INTRODUCTION

Congratulations on the purchase of your Bailey motorhome. We would like to welcome you to the prestigious rank of Bailey owner. We are confident that this vehicle will give you many years of enjoyment.

All Bailey motorhomes have been designed to satisfy the motorhome customer in terms of practicality, comfort, safety and aesthetics.

Depending on the range level, specification and model, this handbook along with its supporting documentation contains all the information you need to give you miles of happy travelling. Inside you will find details on how to operate, maintain and service your Bailey motorhome.

Information leaflets and literature on safe operation of appliances and equipment fitted to your caravan are included in the Bailey information pack. Please read these carefully prior to use.

This manual covers the essential parts of your motorhome, however it is not exhaustive. Detailed information can be obtained from individual manufacturers regarding their products.

Regular maintenance is necessary to ensure trouble-free usage of your motorhome. Your Bailey retailer is equipped to offer service facilities, repair work and any spare parts that you may require.

Always consult your supplying retailer before any additional equipment is fitted. This is to ensure the location of appropriate structural support.

The fitting of electrical equipment or accessories which are not recommended by Peugeot, Ford or Bailey Caravans Ltd (Bailey) may result in the failure of your vehicle's electronic system. It is advisable to contact a Bailey selling retailer who can recommend and fit the correct equipment or accessory for you. For any work to the habitation compartment of your vehicle, a Bailey or AWS approved workshop must be used.

## SAFETY

This handbook contains the information that you will require for your safe enjoyment of your motorhome. All the information contained within is important. However, to draw your attention to specific items we have prefixed them with the following symbols to indicate a warning, caution or note respectively.



**WARNINGS** are instructions that if ignored can cause the user(s) physical harm.



**CAUTIONS** are instructions that if ignored can result in damage to the motorhome.



**NOTES** are reminders that should be heeded.

Bailey offer a variety of leisure vehicles. While each vehicle is designed to feature optimum storage, seating, sleeping and fluid capacities, it is the customer's responsibility to select the correct loads without exceeding the weight capabilities of your vehicle. These weights can be found on the weight plate located on the drivers sun visor and also on the plate found within the gas locker.

It is policy within Bailey to continuously improve their vehicles. While all illustration and descriptive material within this handbook is correct at the time of going to print, the ever-changing market and supply situations may prevent us from maintaining the exact specification details of this handbook. Bailey therefore reserve the right to alter the specification of its products at any time without prior notice.

Please be aware that certain sections are only applicable to certain models.



# GETTING TO KNOW YOUR MOTORHOME

---

Information About Your Motorhome .....	8
Motorhome Model Information .....	9
AL-KO AMC Chassis .....	9
Tow Bar .....	9
Wheels .....	9

# GETTING TO KNOW YOUR MOTORHOME



All Bailey motorhomes have been certified by the National Caravan Council (NCC) for compliance with UK and European standards and Legislation, along with industry codes of Practice relating to health and safety issues. The approval process covers testing and inspection of critical areas of the product including fire safety, weights and dimensions as well as gas, electrics and ventilation.

Every Bailey motorhome carries the NCC Approved Motorhome badge giving you peace of mind that your motorhome is safe and legal.

Your Bailey motorhome is European Whole Vehicle Type Approved. EWVTA ensures the motorhome meets all European regulations and has been constructed in a way that conforms to these rigorous standards for both manufacturing and product safety. This also gives you the ability to register your vehicle in other European countries.

Inside your motorhome document pack, there are the vehicals Certificates of Conformaty: Your retailer should have already registered the vehicle with the DVLA. If further copies of the certificates are needed, please contact your supplying retailer.

## INFORMATION ABOUT YOUR MOTORHOME

To enable your queries to be dealt with more efficiently always quote your Vehicle Identification Number (VIN), a 17-digit number, found in the following locations, as indicated in fig. 3:

- On the windscreen, in the bottom left-hand corner;
- On Peugeot motorhomes the base vehicle data and the AL-KO chassis data can be found under the bonnet on the front of the engine;
- On the statutory plate (fig. 1) gas locker.

You should record both the VIN and production number of your motorhome and store them safely at home.

The motorhome information plate includes the model, size and weight of your motorhome. It is located either inside the top compartment on the dashboard (passenger side) or on the sun visor, above the driver side:

- The EWVTA plate (fig. 1)
- The Bailey weight plate (fig. 2)

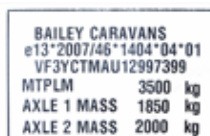

Figure 1



Figure 2

Figure 3



### MOTORHOME MODEL INFORMATION

All Bailey motorhomes are classed as a coach-built motorhome made with insulated laminated panels with a GRP outer skin.

(Type Approval class M1 SA).

### AL-KO AMC CHASSIS

All Bailey Peugeot motorhomes are fitted with an AMC Chassis. Conversion supplied and fitted by AL-KO Kober Limited. As a result the base vehicle has undergone certain changes. The original rear frame has been replaced by a hot-dip galvanised AL-KO lightweight chassis. This chassis is connected to the cab by means of a special bracket assembly. The AL-KO chassis and AL-KO axle with torsion bar suspension is fitted in place of the original manufacturer's chassis and axle.

Repairs to the AL-KO AMC components including the axle assembly must only be carried out by specialist workshops.

### TOW BAR

Vehicles with an AL-KO chassis are approved for use with a trailer. If fitting a tow bar always use one that has been approved by AL-KO and ensure it is fitted correctly.

When ordering a tow bar assembly always indicate the vehicle type and VIN.

You should ensure that the maximum train weight as shown in the registration documents and on the statutory plate is not exceeded.

Suitable rear view mirrors in accordance with road traffic regulations may have to be fitted.

### WHEELS

In the event of a puncture, ensure that the replacement tyre is of the same construction and size as the one that is being removed. The tyre pressures must be suitable.

## GLOSSARY OF TERMS

Word	Meaning
Adamo	Bailey model range
Alliance (SE)	Bailey model range (Silver Edition)
AL-KO AMC chassis	Automotive Chassis Conversion
Alu-Tech	Bailey Brand name for the aluminium framework used in construction of the motorhome
Autograph	Bailey model range
BBQ	Barbecue
BS EN	British Standard European Norm
Butane	A flammable hydrocarbon gas of the alkane series, present in petroleum and natural gas. It is used in bottled form as a fuel.
CO	Carbon Monoxide
DVLA	Driver and Vehicle Licensing Agency
ESD	Electrostatic discharge
GRP	Glass Reinforced Plastic
Heki roof light	Branded roof light
HRP	Hose rupture protection
ISO	International Organisation for Standardisation
LED light	LED lights are the latest technology in energy efficient lighting. LED stands for 'Light Emitting Diode', a semiconductor device that converts electricity into light
LPG	Liquefied petroleum gas
mbar (unit of measurement)	Atmospheric air pressure given in millibar
MPK	Branded roof light
MTPLM	The motorhome's Maximum Technically Permitted Laden Mass (MTPLM) must not be greater than the towing vehicle's Maximum Permissible Towing Mass (MPTW) defined by the vehicle manufacturer.
MIRO	Mass in Running Order (MIRO) is the unladen weight of the standard specification motorhome as it leaves the factory.
NCC	The UK trade body for the tourer, motorhome, caravan holiday home and park home industries
O-ring	A gasket or seal in the form of a ring with a circular cross section, typically made of rubber and used especially in swivelling joints.
ppm (unit of measurement)	Parts per million also can be expressed as milligrams per litre (mg/L). This measurement is the mass of a chemical or contaminant per unit volume of water. Seeing ppm or mg/L on a lab report means the same thing.



Propane	A flammable hydrocarbon gas of the alkane series, present in petroleum and natural gas. It is used in bottled form as a fuel.
Train weight	The gross train weight is the weight of the fully-loaded motorhome plus fully-loaded trailer and must not be exceeded. If your VIN plate doesn't list a train weight, you should not use your vehicle for towing.
UK	United Kingdom
USB	Universal Serial Bus type of connector
V (unit of measurement)	Voltage - the difference in electric potential energy between two points per unit electric charge
VIN	Vehicle Identification Number

**Quality  
online print**

**banners**

**vinyls**

**posters**

**stickers**

**wallpaper**

**correx**

**foamex**



**check us out now to see more**



**display  .com**

# SAFETY AND SECURITY

---

Important Safety Notes.....	14
Security.....	14
Safety Equipment .....	15
Smoke Alarm .....	15
Carbon Monoxide Alarm .....	15

# SAFETY AND SECURITY

## IMPORTANT SAFETY NOTES

To ensure all the occupants of your motorhome enjoy a safe and relaxed environment please observe the following:

- Ensure all the occupants are aware of escape routes in the case of an emergency.
- Always keep escape routes and exit points clear from obstruction and debris.
- Provide one dry powder fire extinguisher of an approved type or complying with ISO 7465 of at least 1kg capacity by the main door, and a fire blanket next to the cooker. Familiarise yourself with your fire extinguisher and the local fire precaution arrangements.
- Your motorhome is a compact living environment, and appliances should be treated in the same way as those in the home to prevent any accidental burning or scalding - keep young children away from hot surfaces.
- Ensure the motorhome is serviced and maintained in accordance with this handbook as well as the base vehicle handbook. The recommendation of manufacturers regarding their appliances must also be followed. Also, ensure that any replacement parts for an appliance conform to the appliance manufacturer's specifications and should be fitted by them or an authorised agent.

Before the vehicle is driven, please ensure that:

- Both the driver and passengers wear seat belts. This is a legal requirement.
- Heavy loads are not stored in top cupboards or in areas from which they may become detached. Please ensure that heavy items are stored low down and take care not to overload individual wheels, the axles or the MTPLM.
- Tables must be secured in their storage positions and/or compartments.
- Cupboards and flaps are in the closed position and secured.
- The refrigerator door is closed and secured.
- Roof ventilators are closed and locked in the down position. This includes the doomed over cab window if fitted.

- The bathroom is not used while the vehicle is in motion.
- Top hinged windows are closed and securely fastened.
- All passengers are secure and wear the appropriate restraint for their height and age.
- Turn off all gas appliances and the gas bottle prior to driving the vehicle.

## SECURITY



The theft of a motorhome can occur in the most unlikely circumstance; from a motorway area, even from an owner's driveway.

Always remember to secure all windows and doors when your motorhome is unoccupied, even if only for a short while.

Do not leave this handbook in the motorhome for extended periods of storage.

Consider fitting any device that may deter or prevent intrusion by thieves. A wheel lock prevents removal of the wheel.

Advice about securing your motorhome, protecting your valuables and property marking, either at home or while on site, can be obtained from your local Crime Prevention Officer through your local Police Station.

Additional security equipment is available from our website: [www.primaleisure.com](http://www.primaleisure.com)



## SAFETY EQUIPMENT

### SMOKE ALARM

The smoke alarm is operational once the battery is connected. When by-products of combustion are sensed, the unit sounds an alarm until the air is cleared.

### BATTERY OPERATION

The operating light (red LED) flashes every 40 seconds confirming that the unit is powered.

- Low Battery Warning: the unit will emit an audible 'chirp' once every 40 seconds for 7 days before the battery needs to be replaced. Failure to replace the battery will result in insufficient power to alert you in a fire.
- Sensitivity test button: tests the circuitry, battery and horn.

### SIMPLE MAINTENANCE

Your alarm requires one 9 volt battery. Under normal use, the battery should last one year.

- Test the smoke alarm after the vehicle has been in storage, before each trip and at least once a week during use.
- Clean your smoke alarm once every three months to help keep the unit working correctly; gently vacuum using the soft brush attachment.

Problems are indicated by two events:

- The alarm does not sound upon pressing the test button.
- The operating light remains steadily on or off (i.e. does not flash every 40 seconds, when the unit is not in alarm).

Try the following:

- Inspect for obvious damage.
- Check that the unit contains recommended battery type.
- Check that the battery cover has been removed.
- Check that the battery is properly connected.
- Gently vacuum as recommended above.
- Replace battery.

If these procedures do not correct the problem, do NOT attempt repairs; replace the smoke alarm.

## CARBON MONOXIDE ALARM

A battery operated alarm is fitted near to the ceiling in your motorhome.

### FEATURES

- An advanced electrochemical sensor designed to accurately measure low levels of carbon monoxide (CO) providing an early warning of toxic CO levels in your motorhome.
- Detects carbon monoxide continuously.
- Resistant to false alarms caused by usual household contaminants.
- Sounds a large 85dB alarm (at 1 metre (3 feet)) to alert you in case of an emergency.
- Simple to mount, portable, ideal for travelling.
- Conforms to the British Standards Institute (BSI) Carbon Monoxide Standard BS EN 50291: 2001.
- 7 Year Warranty.
- Test/Reset button feature.
- Test the sounder, batteries and circuitry.
- Allows you to test the sensor by introducing a source of CO into the detector.
- Silence the loud 85dB sounder during an alarm (only possible when current CO level is less than 50ppm).
- Test the sounder, batteries and circuitry of your detector once per week by pressing and holding the Test/Reset button for 1 second to confirm that the detector is operating properly. The sounder should sound as soon as the button is pressed, and the alarm LED will illuminate red, indicating that the sounder is working and the batteries are providing power to the unit. The test for the sounder, batteries and circuitry should be performed weekly.

### TESTING THE SENSOR

All sensor testing should be carried out by a responsible adult. This test should only be performed once a month. Excessive testing will cause the battery life to be shortened.



CO test kits may be used in order to avoid having to burn cigarettes, incense sticks etc

Please read all steps thoroughly before attempting to test your alarm.

1. If the alarm is wall mounted, unhook the detector from the wall fixing screws.
2. Cover the sounder vents with one hand and hold the Test/Reset button down with your thumb/finger until the power LED illuminates green and the sounder sounds for a second time. (This should happen after 5 seconds). Release the Test/Reset button and the power LED will flash green once every second. This indicates that the sampling rate of the detector has increased and can be tested using a known source of CO.
3. Light an incense stick or a cigarette using a match or a lighter. If using an incense stick, be sure to blow the flame out so that the incense stick is smouldering. Extinguish the lighter, or put out the match and place it into a dish of water.
4. Turn the detector on its side so that the vents on the right hand side of the detector are pointing downwards. Hold the burning incense stick or cigarette around 15 cm (6 inches) below the detector, so that the smoke enters the vents on the side of the detector. An increase in the localised carbon monoxide level within the sensor to more than 50ppm will cause the sounder to sound for one cycle of four loud beeps and the Power LED to illuminate green for a short time. This is the end of the test. The Power LED will no longer flash green every second but will revert to flashing once every minute as the detector will go back to normal operating mode (it may take up to two minutes of exposure to the smoke for the localised level of carbon monoxide within the sensor to reach over 50ppm). Now move the source of CO away from the detector as the test is finished.
5. Put out the incense stick or cigarette by placing it into a dish of water. Ensure all flames have been extinguished.



If the localised CO level within the sensor does not reach 50ppm during the test, the sensor test will stop automatically after 3 minutes.

## UNDERSTANDING YOUR PRODUCT'S INDICATORS

The higher the concentration of carbon monoxide detected by the detector, the quicker it will respond. When sufficient carbon monoxide is detected a loud audible signal (85dB at 1m/3ft) will be emitted and the alarm LED will flash red once every second.

The alarm will sound:

- Between 60 and 90 minutes when exposed to 50ppm of CO
- Between 10 and 40 minutes when exposed to 100ppm of CO
- Within 3 minutes when exposed to 300ppm or more.

## FAULT/LOW BATTERY SIGNAL:

The unit continuously checks the settings of its sensor and circuitry. If any of these settings are found to be incorrect or if the batteries become low then the detector will emit a single audible chirp once per minute for up to 30 days. This does NOT mean that the detector has detected carbon monoxide.

If the device continues to chirp despite having new batteries and the product is still in warranty then contact technical support for advice. If the device is no longer in warranty replace it immediately.

## MAINTAINING/TESTING YOUR DETECTOR

Your detector will alert you to potential hazardous CO concentrations in your motorhome when maintained properly. To maintain your detector in proper working order and to ensure that the sensor will last for the lifetime of the product, it is recommended that you:

- Test the sounder, batteries and circuitry of your detector once per week by pressing and holding the Test/Reset button for 1 second.
- Perform the sensor test monthly.
- Keep the detector free of dust by gently vacuuming with a soft brush attachment when required.

To prevent the possibility of contaminating the sensor in your detector and thus affecting its reliability:

- Never use cleaning solutions on your detector. Simply wipe with a damp cloth.
- Do not paint the detector.
- Do not spray aerosols on or near to the detector.
- Do not use any solvent-based products near to the detector.

Do not attempt to repair your CO detector. Do not remove any screws or open the main casing of your detector. Any attempt to do so may cause malfunction and will invalidate the warranty.



Never ignore any alarm.

#### WHAT TO DO IN THE EVENT OF AN ALARM

- Keep calm and open all the doors and windows to ventilate your motorhome.
- Stop using all fuel burning appliances and ensure where possible they are turned off.
- Evacuate the motorhome leaving doors and windows open.
- Do not re-enter the motorhome until the alarm has stopped.
- Get medical help for anyone suffering the effects of CO poisoning and advise that CO poisoning is suspected.
- Close the windows and doors and do not use the motorhome again until you have had a full service of all appliances by your supplying retailer. In the case of gas appliances they must be tested by a GAS SAFE registered installer. Please contact your Bailey retailer for more details.
- The electro-chemical sensors used in the carbon monoxide alarm have a limited lifespan - therefore it is recommended that a CO alarm is replaced every 5 - 7 years after manufacture or in accordance with the unit's instructions. Be sure check the manufacturing date on the alarms label.

#### FIRE EXTINGUISHERS

It is recommended that a 1kg (2.2lb) minimum capacity dry powder fire extinguisher be located near to the main habitation entrance door.

A pan fire should not have a fire extinguisher aimed at it. A fire blanket should be used. This should be within easy reach of the hob but away from the source of flames.

#### IN CASE OF FIRE

- Get everyone out of the caravan as quickly as possible using whichever exit is quickest, including windows.
- Raise the alarm - call the fire brigade.
- Turn off the gas bottle valve if it is safe to do so.
- The initial use of dry powder extinguishers is recommended only if it is likely that the leakage can be stopped by closing the cylinder valve or that the cylinder can be speedily removed.
- As soon as possible remove cylinders adjacent to the fire to a safe place in order to gain access to the seat of the fire.
- Cool with water all gas cylinders which cannot be removed.



# WEIGHT RESTRICTIONS AND LOADING

---

- Loading And Distribution Of Weight In The Motorhome.....19
- Mass In Running Order (MIRO).....19
- Maximum Technically Permissible Laden Mass (MTPLM):.....19
- User Payload.....19
- Gross Train Mass (GTM) (sometimes referred to as GVW).....20
- Maximum Braked Trailer Mass (MBTM).....20
- Nose Weight.....20
- Advice On Towing.....20
- When loading the trailer.....20
- Axle Loads.....21
- Loading And Distribution Of Weight In The Motorhome.....21
- Roof Loading.....21
- Bike Rack Loading.....21



## WEIGHT RESTRICTIONS AND LOADING

### LOADING AND DISTRIBUTION OF WEIGHT IN THE MOTORHOME

The driver is responsible for arranging items so that they comply with the technical weight limits of the specific motorhome model. For your vehicle dimensions refer to the Weight Data Table in your service manual.

Correct weight distribution is a major factor in making your motorhome a balanced and pleasant vehicle to drive without compromising road-holding. Therefore care should be taken to ensure that heavy items are well spaced and are in as low a position as possible. Larger/heavier items should be stored securely before travelling.

Do not travel with microwaves or televisions in overhead lockers unless the appliance was supplied fitted by the vehicle manufacturer.

### MASS IN RUNNING ORDER (MIRO)

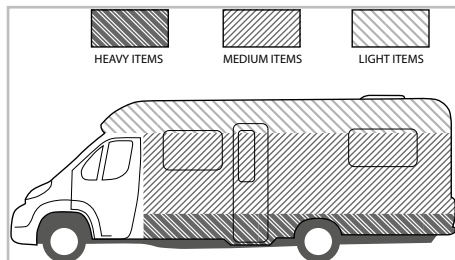

This refers to the weight of your motorhome as it leaves the factory complete with all items supplied as standard. It also includes:

- 90% of fuel capacity
- Driver (75kg)
- One full LPG cylinder
- The heating glycol tank full
- All water tanks empty
- Leisure battery (on Autograph and Alliance SE models)

Any additional passengers/equipment are excluded from the MIRO and need to be taken into account when calculating your available payload.

### MAXIMUM TECHNICALLY PERMISSIBLE LADEN MASS (MTPLM)

This is the maximum allowed weight of the vehicle when it is fully laden for use on the road. Please refer to your Service Handbook for your vehicle MTPLM.



Under no circumstances should the MTPLM of this motorhome be exceeded.

### USER PAYLOAD

Please refer to the Service Handbook for MIRO, Conventional Load and MTPLM values specific to your model.

The load margin (payload) is the difference between the **Mass in Running Order (MIRO)** and the **Maximum Technically Permissible Laden Mass (MTPLM)**. This shows the maximum weight that can be loaded into your motorhome. It covers items such as optional extras, clothing, food, crockery, cutlery, bedding etc.



Please take care to ensure that you have allowed for the masses of all items you intend to carry in your motorhome, e.g. passengers, optional equipment, essential habitation equipment as well as your personal effects.

Your passengers' weight should also be taken into consideration when loading your vehicle. The mass of the conventional load is the mass allowance that your motorhome is designed to accommodate when carrying passengers (excluding the driver). This mass is calculated by multiplying the number of passenger seating positions designated for use when the vehicle is in motion by 75kg. You may wish to allocate the user payload to suit your own use. For example, if it is not being used, the gas cylinders can be left at home to increase the mass available for other items.

## GROSS TRAIN MASS (GTM)

If you are towing a trailer with your Bailey motorhome the gross train mass is the MTPLM of the towing vehicle plus the trailer and the mass of every item carried. The GTM is specified by the base vehicle manufacturer (AL-KO) and is unaffected by the Bailey conversion.

## MAXIMUM BRAKED TRAILER MASS (MBTM)

This is the maximum allowable weight of the trailer together with its load, provided the trailer has a braking system which complies with the local Construction and Use Regulations. The MBTM is given by the base vehicle manufacturer (AL-KO) and is unaffected by the Bailey conversion.

## NOSE WEIGHT

This is the static mass of the trailer towing device on the rear of the towing vehicle.

- When measuring nose weight it is important that the trailer is loaded.
- The trailer is intended to be towed slightly nose heavy. The nose weight can be adjusted by redistribution of the load. The nose weight should be approximately 7% of the actual laden weight (but not greater than the hitch capacity) and at the same time must suit the motorhome requirements.

## ADVICE ON TOWING

The towing specification alters depending on the vehicle's weight.

When towing, the demands on both the driver and the vehicle are increased. Manoeuvrability is reduced together with the ability to climb gradients and accelerate. Braking and vehicle handling are also affected. Towing requires sensible loading of both the motorhome and the towed trailer.

- It is essential that the driver is alert at all times.
- Pull over if you feel tired and get some rest.
- Brake in good time and take special care when driving down steep gradients.
- Use your gears and change down before going down a steep hill so that the engine also acts as a brake.

- Ensure that the tyre pressures are correct on both your motorhome and the towed trailer.
- Regularly check the towed trailer's brakes and lights.

## WHEN LOADING THE TRAILER

Ensure that the loads are properly secured for transit:

- Position loads so that most of the weight is placed close to the floor and, where possible, immediately above or close to the axle(s).
- Where the load can be divided between the towed trailer and the motorhome it is advisable to load more into the motorhome as this will greatly increase the stability of the combination.
- After loading always check the maximum weight does not exceed the manufacturer's recommendations.
- Check the front and rear axle weights of the motorhome are not exceeded due to loading the trailer. The easiest way to do this is to take the vehicle to a weighbridge.
- Do not exceed the motorhome gross vehicle train weight.
- Do not exceed the maximum front and rear axle loads on the motorhome.
- Only tow bars complying with 94/20/EC should be fitted to the motorhome.
- The maximum permitted mass of an unbraked trailer is 750kg.
- The maximum permitted vehicle combination length is 18.75m. However, any combination must ensure compliance with the turning circle requirements of Construction and Use regulations 1986 and 97/27/EC.



Towing regulations vary depending upon the country you are visiting. It is important that you make yourself aware of each country's regulations before you visit.

### AXLE LOADS

Individual axles have upper limits. The sum of the two axle upper limits usually exceeds the overall vehicle MTPLM, but this does not mean you can load each axle to its maximum, because doing so would exceed the overall MTPLM of the whole vehicle.

### LOADING AND DISTRIBUTION OF WEIGHT IN THE MOTORHOME

Tables must be secured in their storage positions and/or compartments. Items fitted other than standard equipment will deplete the payload stated in the Service Handbook.

### ROOF LOADING

Prior to fitting any type of roof mounted item please consult with your Bailey retailer to ensure the roof has the correct structural provisions to accept the item. Do not allow children to climb on the roof of your motorhome.

Roof rack bars and ladders are an aftermarket option and if you are considering them, care should be taken to ensure that all items can be safely secured.

Maximum load within the area encompassed by the roof rack should not exceed 75kg (165lb) with a maximum loading of 24kg per metre<sup>2</sup> (8Kg (17lbs) per square foot).



Take special care when on the roof particularly in wet or frosty weather conditions, as the surface could be slippery. Always wear practical footwear when climbing onto your vehicle.

### BIKE RACK LOADING

Your motorhome is fitted with bike rack rail fixing points. When fitting a bike rack check with the manufacturer that it is a motorhome approved rack and ensure that safety regulations and weight restrictions are adhered to.

Do not place a cover over the bikes as this may restrict vision on models with rear view cameras



PLEASE TAKE CARE TO ENSURE THAT YOU HAVE ALLOWED FOR THE MASSES OF ALL ITEMS YOU INTEND TO CARRY IN THE MOTORHOME. e.g. passengers, optional equipment, essential habitation equipment and personal effects such as clothing, food, pets, bicycles, sailboards, sports equipment etc.



UNDER NO CIRCUMSTANCES SHOULD THE REGISTRATION MASS OF THIS MOTORHOME BE EXCEEDED



THE MASS IN RUNNING ORDER CONTAINS A PROVISION FOR THE MASSES OF LIQUIDS, GAS ETC. (SEE ESSENTIAL HABITATION EQUIPMENT IN USER HANDBOOK). PART OF THIS PROVISION CAN ALSO BE UTILISED AS ADDITIONAL PAYLOAD IF FOR EXAMPLE YOU WISH TO TRAVEL WITH NO GAS CYLINDERS



## **THE AL-KO AMC CHASSIS**

### **ENGINEERED FOR A SAFER AND MORE ENJOYABLE MOTORHOME HOLIDAY**



Drive safe and arrive ready for your holiday with the advanced AL-KO AMC Chassis. Engineered specifically for modern motorhomes, AL-KO AMC provides the ultimate in comfort and superb driving dynamics to ensure your holiday begins the moment you set off.

The leading motorhome brands integrate AL-KO AMC into their latest vehicles to ensure even greater levels of comfort, performance, and safety:

- Improved road holding and ride comfort
- Driving and cornering performance
- Safety and handling on the road

**Discover the wide range of motorhomes that benefit from AL-KO AMC - speak to your dealer or visit our website.**

For further information: [www.alko-tech.com](http://www.alko-tech.com) | 01926 818500 | [marketing.uk@alko-tech.com](mailto:marketing.uk@alko-tech.com)

**AL-KO**  
QUALITY FOR LIFE

## BEFORE MOVING OFF

---

Whenever you plan to use your motorhome it is good practice to run through this simple checklist before you set off:

- Ensure that there is sufficient gas to meet your needs.
- Check that gas cylinders are securely fastened.
- Turn off the gas supply at the bottle.
- Turn OFF all gas manifold taps (located under the sink).
- Ensure that the gas cylinder and locker door are securely fastened.
- Switch off the 230V supply at the site's hook-up supply pillar and disconnect (beware of potential electric shock from a wet cable). Coil up cable and store in a safe place.
- Check both the control panel and the PDU box for operation.
- Check and, if necessary, charge your leisure battery. This can be viewed on your control panel.
- Check that the battery is secure and that the battery box door is securely fastened.
- Ensure that the fridge is set to 12V operation and the door lock is set. (Please note that the electrical relays will allow the fridge to run on the vehicle battery when the engine is running.)
- Ensure that your fresh water and waste water tanks are empty.
- Remove any external fresh water connections, coil and store in a secure place.
- Ensure that the toilet flush tank is empty in order to minimise the risk of leaks or spillage while the vehicle is in motion.
- Move the toilet blade handle to the closed position.
- Close and secure all cupboards and drawers and check for any loose articles.
- Do not store tins, jars, cylinders etc. in overhead lockers.
- Close and secure all windows and roof lights.
- Leave all curtains and blinds open.
- Make sure any heavy articles are stored in accordance with the loading procedure.
- Ensure tables are in their specified storage compartments.
- Lock the habitation door (remember to remove the keys).
- Check your wing mirrors and adjust if necessary.
- Check that the wheel bolts are secure and that the tyre pressures are correct.
- Check underneath the vehicle for any stray items.
- Safely store your levelling blocks away in an appropriate place.



## PROUD GRAPHIC & EMBLEM SUPPLIER TO Bailey of Bristol Caravans & Motorhomes



We are CGI - A global branding solutions innovator providing design, production and installation services to the leisure, aerospace, automotive and retail industries. Our philosophy has always been to manufacture and supply leisure graphics and branding products that enhance our customers' own products and raise brand awareness. Ideal for adding an element of luxury or personalisation, we also provide a wide range of badging technologies.



BRAND ENGINEERS

[www.cgi-visual.com](http://www.cgi-visual.com) | 01234 846 000

# TRAVELLING

---

Driving Licence.....	26
Driving.....	26
Speed Limits UK).....	26
Front Seat Swivel.....	27
Dedicated travelling passenger seating.....	27
Seat Belt Legislation.....	27
Child Seats - Positioning/Fitting.....	29
Using the Seat Belts.....	29
Airbag.....	29
Noise Vibration.....	29
Jacking the motorhome.....	29
Changing front wheels.....	29
Changing rear wheels.....	29
Fix and Go tyre repair.....	30



# TRAVELLING

## DRIVING LICENCE

Before you drive or allow any other person to drive your motorhome you must check driving licence entitlements against the criteria of your particular vehicle. If your licence was issued before 1 January 1997 it may already include some higher categories.



Never permit anyone without a valid driving licence to drive your motorhome.

### CATEGORY B

With this category on your driving licence you can drive vehicles with a MTPLM of up to 3500Kg with eight passenger seats and a trailer less than 750Kg.

It's also possible to tow a braked trailer heavier than 750Kg if the combined MTPLM and trailer are less than 3500Kg. The trailer must also be lighter than the vehicle towing it.

To tow a trailer more than 750Kg than mentioned above you will need category B+E.

### CATEGORY C1

With this category you can drive vehicles weighing between 3500Kg and 7500Kg (with a trailer up to 750Kg). To tow a heavier trailer you'll need category C1+E.

### CATEGORY C

With this category you can drive vehicles over 3500Kg (with a trailer up to 750Kg).

### CATEGORY C+E

You can drive category C vehicles with a trailer over 750Kg.

Vehicle classifications

Motorhomes up to 3500Kg MTPLM are classed as P/LGV (Private Light Goods Vehicles).

Motorhomes with a MTPLM over 3500Kg and up to 7500Kg are classed as P/HGV (Private Heavy Goods Vehicles). These are normally used to define MOT classifications and vehicle excise duty (road tax) classifications.

Refer to DVLA website for latest current licence entitlement and restrictions.

## DRIVING

When using a motorhome on either the public highway or a private road, the Highway Code should be complied with and full consideration given to other road users.

In the event of a motorhome travelling slowly and there being a queue of traffic behind, the driver of the motorhome should, where possible, pull over in order to let the other traffic pass.



When the vehicle is in motion it is compulsory that all passengers are seated and seat restraints worn.

When the vehicle is being driven, refuelled or is on a ferry all gas systems must be turned off at the gas supply cylinder.

### SPEED LIMITS (UK)

If your motorhome is 3.05\* tonnes or under and no speed limit is in place it can be driven up to 70 mph\*\* on motorways and dual carriageways, 60 mph on single carriageways. If your motorhome exceeds 3.05 tonnes\* speed reductions must be observed: 70 mph on motorways, dual carriageways 60 mph, single carriageways 50 mph. Reduce speed in high or cross winds, downhill or when visibility is poor.

- High sided vehicles cause air buffeting so extra care must be taken when passing or being passed. Leave as much space as possible when passing or being passed.
- When passing other vehicles allow more room than the normal clearance you would allow when driving a car.
- Allow longer to get up to speed and overtake.
- Do not swing out suddenly.
- Carry out all manoeuvres as smoothly as possible.
- Use wing mirrors to check that the motorhome has fully cleared a vehicle when overtaking.

(\*Weights are unladen)

(\*\*Autograph 816 is limited to 68 mph / 110 km/h)

### FRONT SEAT SWIVEL

The cab seats swivel for convenience when you are on site. However, when the vehicle is being driven they MUST be locked in their forward position.

### DEDICATED TRAVELLING PASSENGER SEATING

Seat belts are fitted to all travelling seats. Designated travelling seats have been fitted to some layouts to ensure the safety of your passengers. These seats vary according to the layout that you have purchased. Each seatbelt frame is tested to the relevant safety requirements.



**NEVER** travel in or attempt to install a seat belt to a non-designated seat.

Side-facing seats are for habitation use only, not for use when the vehicle is in motion.

### SEAT BELT LEGISLATION

When the vehicle is in motion seat belts must be worn by the driver and all passengers. In addition children aged under 3 years must wear an appropriate child restraint such as a booster seat suitable for their height and weight. Children must normally use a child car seat until they're 12 years old or 135 centimetres tall, whichever comes first. Children over 135 cm (4'5") in height or over 12 years of age must wear a seat belt. It is the legal responsibility of the driver to ensure children aged up to 14 are suitably restrained. For passengers aged 14 and over, it is their responsibility (not the driver's).

Three point seat belts are located in the habitation compartment of your motorhome, fitted for you and your passenger's safety these must be worn unless you have a Certificate of Exemption from Compulsory Seat Belt Wearing. This certificate must be produced if requested by the police.

## Adamo models only 60-4, 75-41, 75-4T and 75-4DL Travel Seat Configuration

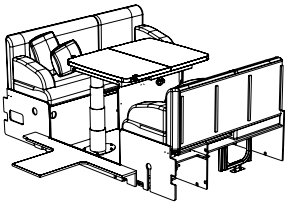

1. The lounge in the travel configuration.

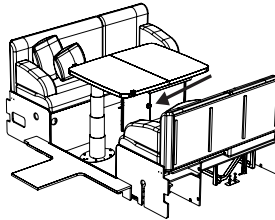

2. Open the front bunk flap on the offside bunk and secure open using the attachment on the bunk face.

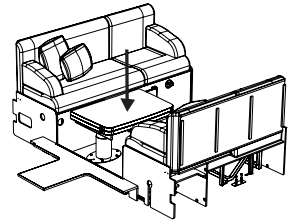

3. Fold, rotate and secure clips before lowering the table.

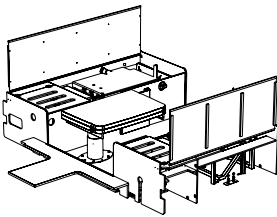

4. Remove all bunk cushions.

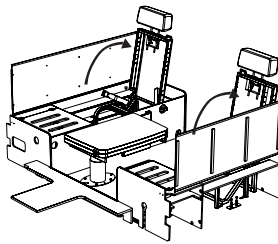

5. Using lever on the face of the bunks, adjust seats to an upright seating position.

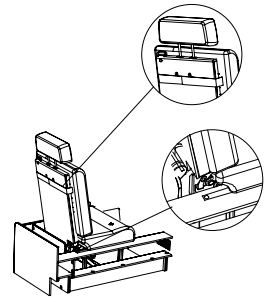

6. Locate the seat cushion with the poppers and secure to bunk. Once secure, locate the back rest with the velcro straps and secure to the travel seat.

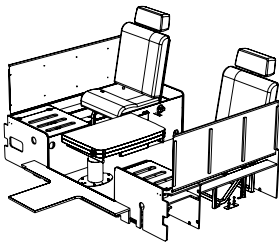

8. Safely store remaining cushions away ready for travel.

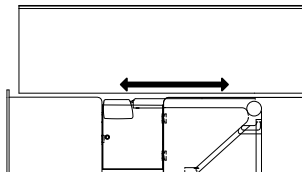

9. When folding away the traveling seat make sure the seat is returned to its horizontal position. Do not rotate past horizontal

## CHILD SEATS - POSITIONING/FITTING

Check with the retailer on the suitability of the child seat for your motorhome.



If a child seat is fitted to the front passenger seat of the cab, refer to the base vehicle handbook regarding the position and air bag operation. A warning sticker is visible inside the sun visor (passenger side) to remind you of this.

All of the motorhomes are fitted with inertia seat belts however the child seat must be tight in the adult seat. Push all your weight into the child seat as you tighten the belt. Keep a copy of the child seat fitting instruction in the motorhome for easy reference.

## USING THE SEAT BELTS

- To fasten: insert the buckle into the plug-in socket until it clicks.
- To release: press the red release button; the buckle will be ejected from the plug-in socket.
- The belt is designed for one person and must not be put around a child seated on someone's lap.
- It is suitable for retaining most child seats and boosters.
- It should always be used according to these instructions and adjusted accordingly.
- Never wear a slack seat belt.
- When installed correctly the seat belt should pass across the centre of the shoulder and fix into the plug-in socket beside the hip.
- It is important that the strap is not twisted during use as this can cause damage.
- Webbing must not be allowed to rub against sharp surfaces as this could lead to strap damage. If a belt is showing signs of wear (frayed, damaged or stressed) it should be replaced.
- Always replace a seat belt after an impact.
- Always check the anchorage points after an impact; if these are deformed the seatbelt frame will need to be replaced.
- Never modify the belt.
- Inspect your seat belt on a regular basis.

## AIRBAG

For information about the airbag, check the base vehicle handbook.

## NOISE VIBRATION

We understand that a quieter journey adds to your comfort as a traveller, so Bailey have used high density acoustic foam in the construction of your motorhome.

To help to reduce noise during transit:

- Store the grill pan and shelves in the storage compartment at the bottom of the oven. Wrap in a tea towel for further protection.
- Windows - the window stays on your motorhome have a tendency to rattle. We suggest that you tighten the stay and secure the catches, before you travel.
- Cab Blinds - check that the cab blinds are fitted correctly. If they have become detached during transit please return your vehicle to your retailer and ask them to refit the blinds.
- The glass lid cover on the hob is also fitted with bump stops to prevent the glass from rattling on the trivet. Over a period of time, these bump stops may move from their ideal position. Reposition them or place a tea towel under the glass lid - please ensure that you remove the tea towel before you commence cooking.

## JACKING THE MOTORHOME

Rear jacking points are located in the shock absorber mounts on the left and right, in front of the axle. When changing a rear wheel raise the vehicle to the maximum extent of the jack. In order to clear the skirt when removing the wheel, tilt the bottom of the wheel under the vehicle and allow the top of the wheel to fall towards you and clear of the hub.

## CHANGING FRONT WHEELS

Select first or reverse gear, apply the handbrake and chock the remaining wheel.

## CHANGING REAR WHEELS

Select first or reverse gear. DO NOT apply the handbrake but fit chocks under the remaining wheels.

## WHEEL NUT TORQUE SETTINGS

Peugeot: 15" wheel - 160Nm,  
16" wheel - 180Nm

Ford: 200Nm

### SPARE WHEEL CARRIER

The spare wheel carrier fitted in your leisure vehicle (model specific) is much like that fitted onto a car.

#### TO LOWER THE ALLIANCE SE SPARE WHEEL:

1. Remove the plastic stopper in the floor.
2. The winder for the spare wheel carrier can be found in the kit bag supplied with the vehicle.
3. Remove the winder from the kit bag and insert the hooked end of the crank in the spare wheel retaining attachment.
4. Lower the spare wheel to the ground, with a little amount of slack. Pull the wheel out as far as possible before slackening the cable further. Repeat until the wheel is in the desired position.
5. Draw the spare wheel towards you from under the leisure vehicle.
6. Pivot the toggle at the end of the cable 90 degrees to release it from the spare wheel.
7. Crank up the cable again by turning the crank clockwise.

#### RETURNING THE SPARE WHEEL TO THE STORAGE COMPARTMENT:

1. Use the crank to lower the spare wheel's retaining cable. When there is no wheel attached, the cable will need to be gently pulled from the carrier.
2. Pass the toggle at the end of the cable through the centre hole in the spare wheel. Pivot the toggle 90 degrees so that when raised, the wheel will rest on the toggle.
3. Retract the retaining cable slightly by slowly turning the crank clockwise several times.
4. Position the wheel so that it is not obstructed by components under the floor.
5. Continue to raise the wheel by turning the crank clockwise. Raise the wheel a little bit at a time and guide it until it is securely seated against the floor.
6. When it is no longer possible to turn the crank, check that the spare wheel is seated tight against the underside of the floor.
7. Replace the plastic stopper inside the vehicle.

#### TO LOWER THE AUTOGRAPH SPARE WHEEL:

The AL-KO AMC Spare Wheel Carrier is fitted to the Autograph range. When needed simply unhook the fasteners at the rear of the chassis,

which will allow the carrier to swing down for wheel removal.

### FIX AND GO

The information required by current legislation is provided on the kits label. Compliance with all of the instructions on the label is an essential condition to guarantee the safety and effectiveness of the Fix and Go kit. Read the label carefully before use. Avoid all improper use. Fix and Go carries an expiry date and must be replaced periodically. The kit must be used by adults and cannot be left to minors to use.



Show the container label to any staff who need to handle tyres treated with the tyre repair kit

Fix and Go is used for temporary repairs and therefore the tyre needs to be examined and repaired by a specialist as quickly as possible. The sealant is effective at temperatures from -40c to +50c. Tyres with tread damage up to a maximum diameter of 4mm can be repaired, but not those with damaged sides. Before using the Fix and Go Kit, make sure that the tyre is not too damaged and that the rim is in good condition, otherwise call for roadside assistance. Do not remove any foreign bodies from the tyre. Do not leave the compressor working for over 20 minutes at any one time, danger of overheating. Once the tire has reached the required pressure, then you may continue driving. Do not exceed 80 KM/H. Do not accelerate or brake suddenly.

After driving for about 8 KM / 5 miles, check the pressure in the tire."



Please observe the fix and go speed limits

# SETTING UP UPON ARRIVAL

---

Setting up Your Motorhome.....	32
Levelling Your Motorhome.....	32
Connect to Mains Electricity.....	32
Connect the Gas Supply.....	32
Fill up the Fresh Water Tank.....	33
Powering your Fridge.....	34
Turning on the Heating.....	34
Connect your TV and Digital Antenna.....	34

# SETTING UP UPON ARRIVAL

## SETTING UP YOUR MOTORHOME

The following are brief, but not exhaustive, instructions on how to initially set up your motorhome when you have arrived at your destination.

Report to reception for information about the site rules and carefully select where you wish to park your motorhome

The site should be as level as possible, well drained and away from boggy areas, and preferably not under or near to trees. Consider how you will move your motorhome when you are leaving site; for example on sloping ground in wet conditions, pitch facing downhill.

Where possible leave 6 metres (20ft) of free space around your vehicle.

## LEVELLING YOUR MOTORHOME

It is important to site your motorhome level so as to ensure the correct operation of the refrigerator, cooker, microwave etc. Always use motorhome specific ramps rated for the weight of your vehicle.

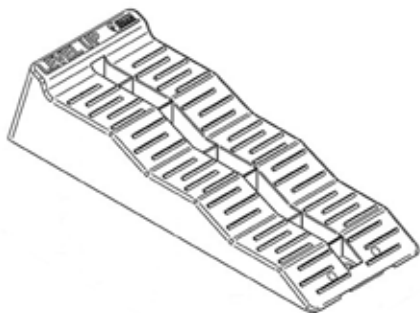

## MAINS POWER CONNECTION

1st connect the 230v to motorhome by plugging your 3pin lead into the 230v inlet socket on the outside of your motorhome and 2nd into the socket on the site supply bollard. Always test the circuit breaker on the PDU once connected.

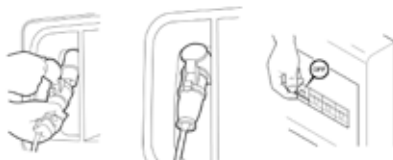

## GAS SUPPLY

1. Open the cylinder valve.
2. If fitted, firmly press the hose rupture protection (green button) on the high-pressure hose for about 5 seconds.

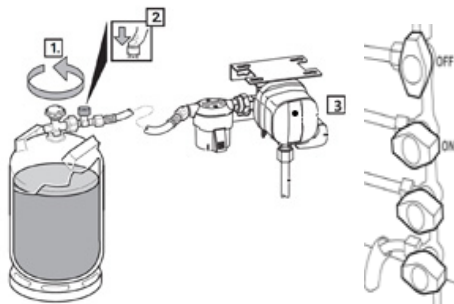

Turn on all the taps at the manifold (located in the kitchen) which are labelled and serve the individual appliances. Please bear in mind that if there is still some air in the supply pipes the ignition of gas equipment may take longer than usual.



**FILLING THE FRESH WATER TANK**

1. Close all taps.
2. Close drain valve located next to the water heater/boiler.

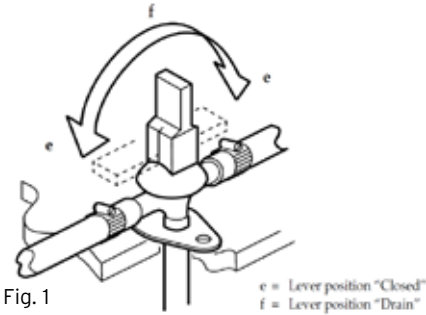

3. Autograph and Adamo - Fill the tank via an aqua roll and submersible pump plugged into the Whale pump inlet on the side of the motor home Fig. 2. Alternatively remove the lid of the tank (found underneath the hatch in the floor of your motorhome Fig. 3) using a standard hose.

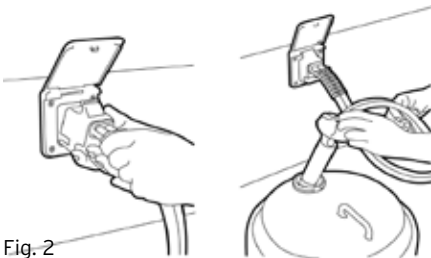

4. Alliance only - Locate the fresh water inlet found on the side of your motorhome. Remove the locking cap and use a standard hose to fill the tank via this inlet Fig 4.



5. When in the fresh water tank section on the control panel the percentage of fill is shown on the screen.

**ONCE THE TANK IS FULL**

6. Turn on the pump at your control panel. The light will come on when water is being pumped.
7. Open the hot kitchen tap and allow the system to purge itself of air until there is a steady flow of water. This will also fill the water heater ready for heating. Close kitchen tap.
8. Open the cold water tap and allow the system to purge itself of air until there is a steady flow of water.
9. Repeat operation for washroom.

**CASSETTE TOILET**

Withdraw the cassette and add the appropriate dose of chemical treatment along with 2-3 litres of water via the spout.



## FRIDGE POWER

The refrigerator is equipped to run using a choice of three types of power; 12v, 230v and Gas (Propane/Butane liquid gas). A rotary selector is located at the top of the refrigerator. You should turn the selector to the power source you wish to use.

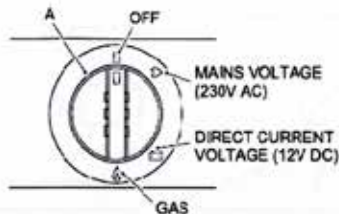

## SWITCHING ON THE RND10.5 AND RND10.5X REFRIGERATOR

- Press on/off button for 2 seconds
- Repeatedly press mode button, until the LED indicates the desired operating mode.
- Repeatedly press temperature selection button, until the desired temperature level is set

## SWITCHING ON THE THETFORD N SERIES FRIDGE

Push the on/off button and hold it for 1 second. The light in the on/off button turns blue and the last selected settings with light up.

## HOT WATER AND HEATING

Once everything has been set up you will possibly want to heat water and also the motorhome.

## AUTOGRAPH MODELS



1. Turn on Alde control panel. The colour screen will light up and show the menu.
2. Press the MENU button.
3. From this touch screen you will be able to control the heating and water temperature. (See Alde heating section)

## ALLIANCE & ADAMO MODELS



1. Press the rotary knob.
2. The colour screen will light up and show the menu.
3. From this touch screen you will be able to control the heating and water temperature. (See Truma heating section).



Please note that hot water is not instant and will take time to heat up.

## TELEVISION AERIAL

Your caravan is supplied with a Vision Plus aerial which is already fitted.

1. Determine whether the TV transmissions are horizontal or vertical and use the winder to change the aerial to suit.
2. Loosen the mast locking collar and raise the antenna.
3. Switch on the amplifier. The light will illuminate.
4. Rotate the antenna until the LED turns green.
5. Increase the gain to max.
6. Turn on your TV and tune in the channels.

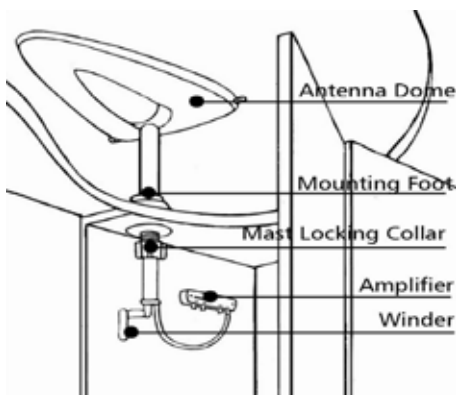

# THE WATER SYSTEM

---

The Autograph Water System.....	36
Whale Aquasource.....	36
Whale Submersible Pump.....	37
Manual Tank Filling .....	38
Alliance Water System.....	39
Filling with Fresh Water .....	39
Pressure Switch.....	39
Checking The Water Level.....	40
Draining and Winterising the Water System .....	40
Manually Draining the Fresh and Waste Water Tanks .....	41

## THE WATER SYSTEM

### AUTOGRAPH AND ADAMO WATER SYSTEM

Bailey motorhomes are equipped with both fresh and waste water systems. The pipes used within the fresh water system are WRAS approved (Water Regulation Advisory Scheme) non-toxic food quality pipes.

Autograph Models have both fresh and waste water tanks installed underneath the floor between the chassis members.



Bailey state that all fluids should be drained from your motorhome prior to being in transit. The weight of any fluids within the motorhome whilst in transit must be deducted from your payload. Please ensure you have sufficient allowance before travelling.

The Autograph and Adamo water system can be filled in three different ways:

- > The Whale Aquasource mains hook-up
- > Whale submersible pump (Via aqua roll)
- > Manual tank filling

### WHALE AQUASOURCE



#### TO INSTALL THE WHALE AQUASOURCE

The Whale Aquasource is used when a drinking water tap is located within approximately 7 metres of the vehicle. When in place the system provides continuous water to the motorhome from said tap.

In order for you to use the Whale Aquasource you will firstly need to configure the Seattle control panel within your motorhome by completing the following:



Press the down arrow to view the Fresh Water Filling symbol, then press enter. 'Start filling the tank' is displayed. (If the pump is turned off, the notice 'Turn pump on to use this function' will be displayed).

1. Lift the lid to the external Whale Watermaster socket (located on the side wall of the motorhome).
2. Insert the Whale Aquasource plug firmly into the socket and close the lid. The lid locates and locks the Whale Aquasource plug into place.
3. Connect the other end of the Whale Aquasource to a water tap and turn it on, making sure there are no kinks in the pipe.
4. When water flows from the overflow pipe in the fresh water tank or the control panel alarm sounds, turn off the tap. The on-board tank is now full.

**TO REMOVE THE WHALE AQUASOURCE**

1. Disconnect the Whale Aquasource from the tap.
2. Lift the lid of the socket to the vertical position.
3. Depress the two white location buttons on the Whale Watermaster plug and remove from the socket.
4. Close the lid of the socket.
5. Stow away the in a clean, chemical-free area.



When you are using the Aquasource system it is important that you do not leave the vehicle unattended without turning the water source off at the supply point.

**WHALE SUBMERSIBLE PUMP**

The Whale Submersible pump is designed to run when fully submerged in water. It pumps water from an aqua roll container to the fresh water tank. 2.5 aqua rolls will fill the tank.

**TO INSTALL THE WHALE SUBMERSIBLE PUMP**

1. Fill a suitable water container and place it below the Whale Watermaster socket (located on the outside wall of the motorhome).
2. Place the Whale submersible pump into the water container. The pump should reach the bottom of the container.
3. Lift the lid of the external Whale Watermaster socket.
4. Insert the plug (opposite end to the pump) firmly into the socket and close the lid to locate and lock the pump plug into place.
5. When the control panel switch is on the pump will automatically pump water into the fresh water tank.
6. When the on-board tank is full the pump will turn off.
7. To remove the Whale submersible pump, lift the lid of the Whale Watermaster socket into the vertical position.
8. Remove the Whale submersible pump plug from the Whale Watermaster socket.
9. Close the lid of the Whale Watermaster socket.



When the water container is empty the pump will continue to run.



The maximum continuous operation should not exceed 15 minutes.

It should be noted that as the container volume is likely to be less than that of the on-board tank, it is advisable to remain in attendance when filling the tank as the life of the pump will be drastically reduced if allowed to run dry. To fill an onboard tank to the brim you normally have to repeat this procedure several times.

Should the motorhome be left unattended, or the water supply has run dry, switch off the power supply to the pump via the control panel to avoid continuous running.

### MANUAL TANK FILLING



The tank can be filled manually using a standard hose inserted directly into the tank.

The fresh water tank can be accessed via the hatch in the floor of your motorhome.

1. Remove the hatch cover.
2. Unscrew the tank filler cap.
3. Insert hose and turn on tap.
4. Monitor the level of the tank via the control panel or visually within the tank.
5. Turn off and remove hose.
6. Replace tank cap.
7. Replace hatch cover.

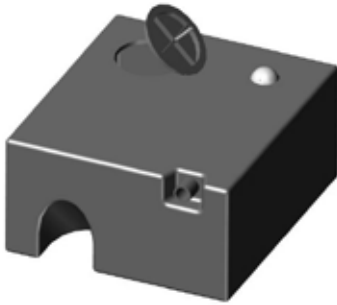
**ALLIANCE WATER SYSTEM**

Alliance Models have an on-board fresh water tank located either underneath the bed or within a bunk dependant on the model. All waste water tanks are installed underneath the floor between the chassis members.

All fresh water tanks use a Whale submersible pump found within the tank to pump water around the motorhome.

The pump is already fully installed and will run when the pump is turned on via the control panel. Water will flow when a tap within the motorhome is opened.

The pump should be inspected and cleaned at frequent intervals. Ensure the water supply is free of debris; this will reduce the likelihood of the pump clogging.

These pumps are sealed units so no further maintenance is required.



**Winterising:** To protect against damage as a result of freezing, drain the entire water system when not in use.

**FILLING WITH FRESH WATER**

To fill the onboard fresh water tank connect a standard water hose to an external tap, then feed the other end into the fresh water filler (shown above).

Monitor the water level inside the tank from the control panel.

**PRESSURE SWITCH**

Your pressure switch is factory set and should not normally require adjustment. However, adjustment may be required if the power supply voltage has varied from the previous setting, either due to battery drainage or higher voltage being supplied when the battery charger is operating. In the event that your pump doesn't switch off when you close the taps or it pulses on and off rapidly when the taps are fully open, follow these guidelines to re-adjust the pressure switch setting.



1. Ensure the system, including the heater, is full of water and all taps are closed.
2. Tighten the adjusting screw clockwise until the pump comes on. (For integral socket based pressure switches, first loosen the pressure switch locknut in an anti-clockwise direction).
3. Open any tap until you have a smooth flow of water, then close the tap. You should hear the pump running and the pump running light, if fitted, will be on.
4. Return to the pressure switch and slowly turn the pressure switch adjustment screw anti-clockwise until the pump has stopped. Turn the screw a further half turn (180 degrees) anti-clockwise.
5. Check for correct operation by opening and closing all taps individually. The pump should turn on when the cold tap is opened and switch off immediately when the cold tap is closed.



There will normally be some pulsations at lower flows. The hot side may take a few seconds to react (both on and off) due to cushioning effect in the water heater.

For integral socket-based pressure switches, carefully tighten the locknut until it is in the correct position keeping the adjustment screw in position.

If the setting of the pressure switch is still not correct you may experience one of the following issues:

**Problem:** Pump running continuously, even with tap closed. If undiscovered, could result in pump failure and flat battery. Most likely causes are that present voltage is significantly lower when last adjusted, or water container is empty.

**Solution:** Re-adjust switch or refill container.

**Problem:** Pump does not run at all. If not due to a blown fuse or faulty connections, then most likely cause is excessive running (see above)

**Solution:** Replace pump and re-adjust switch.

**Problem:** Pump runs intermittently ON, OFF etc. Seen as pulsing flow from tap, or as inability to set constant water temperature, water goes hot, cold, hot, cold instead of constant warm. Most likely cause is that present voltage is higher than when last adjusted.

**Solution:** Re-adjust pressure switch. If problem persists add a Whale Surge Damper (WS7205.)

**Problem:** Pump runs very noisily but does not pump water. Likely to occur after water container has been refilled. Pump is air-locked and is fighting to get air out and water in.

**Solution:** Unplug from the socket, allowing pump to flood, and reconnect by plugging in again. The correct sequence when refilling the container is to unplug, put pump into container, then reconnect.



If after following these procedures the system continues to pulse when all taps are closed there may be a leak in the system. Consult your retailer for advice and assistance.

## TO CHECK THE WATER LEVEL



Press the down arrow until you see the fresh water icon; the level is shown as a percentage.



Press the down arrow until you see the waste water icon; the level is shown as a percentage.

## DRAINING AND WINTERISING THE FRESH WATER SYSTEMS

Motorhomes are often used all year round but when they are not in use, even for short periods, they should be drained down. One night in freezing temperatures is all that is required for expensive and permanent damage to occur to water system components.

Follow this procedure to prevent any damage:

1. Open all taps; lift the mixer tap levers into the central position to allow both the hot and cold water to drain.

2. Remove the shower head; unscrew by hand then shake out and store in a dry place.
3. Open the drain valve (to the side of the onboard tank in Alliance models. To the side of the boiler on Autograph models).
4. Turn on the pump to drain the system.

### MANUALLY DRAINING THE FRESH AND WASTE WATER TANKS (ALL MODELS)

An inspection cap is positioned on the top of the tank to allow access to the drain plug which is situated inside the tank.

To drain the waste water tank move your vehicle to a waste water disposal point. Open the waste water drain tap (positioned behind the rear wheel of the vehicle) and allow the water to drain.

### BREATHERS

Both tanks are fitted with breather pipes. This allows for air displacement when filling. When filling the fresh water tank, water may escape through these breather pipes - this should give no cause for concern.

### BAFFLES

For added stability and driving comfort the water tanks in your vehicle are fitted with baffles. These baffles stop the water from flowing freely from side to side, creating uneven weight distribution.

### FROST PROTECTION

If the vehicle is not being used during freezing conditions the water must be drained.



Frost damage cannot be claimed under warranty.



Manual draining must always be completed when winterising. This will ensure a full drain.

# THETFORD



The Thetford Concentrated Family



## NO MORE NASTY GREY WATER SMELLS

coming from your drains!



Use every time after you empty your grey water tank



Pour directly into the sink or shower drain and add water



No more nasty grey water smells

thetford.com



The Club, now over 40 years old, founded on friendship, fun and freedom, is run by and for the members and is dedicated to the hobby of rallying with Bailey caravans and motorhomes.

Rallies may be small or large, run for a specific purpose with a diverse range of activities. Biennially Bailey open the factory exclusively for Bailey Owner's Club members.

We fundraise for a range of charities throughout the year.

It couldn't be easier to join - simply go to [www.baileyownersclub.org](http://www.baileyownersclub.org) for full details on how to become a member.

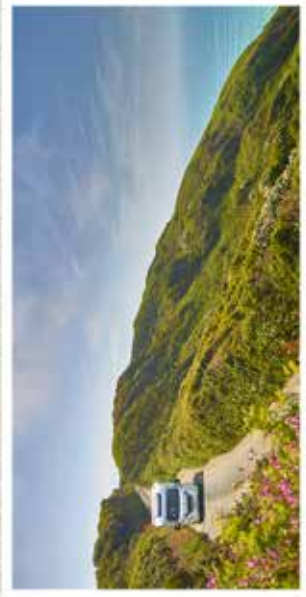

# THE GAS SYSTEM

---

- Types of Gas..... 44
- Safe Use Of Gas Supply To Appliances..... 44
- Regulator ..... 44
- Truma Monocontrol Cs Safety Gas Pressure Regulator ..... 45
- Gas System Maintenance..... 46
- Changing The LPG Cylinder ..... 46
- Cylinder Change..... 46
- Hose Replacement..... 46
- Gas Leaks..... 47
- Ventilation ..... 47
- General Safety Notes..... 47
- Fire Precautions..... 48

# THE GAS SYSTEM

## TYPES OF GAS



The gas system meets BS EN 1949:2011+A1:2013 and should only be modified by a competent person.

Bottled Liquefied Petroleum Gas (LPG) is the most convenient portable source of fuel for your vehicle:

- Butane - supplied in the UK in green or blue bottles. Continental bottles usually have a male left hand thread similar to but not identical to UK Butane. Butane is suitable for use at temperatures down to 2°C but will not work below that temperature.
- Propane - supplied in red, or partly red bottles and have a female left hand threaded connector. Germany and Austria supply propane with a male connection. Propane will work at temperatures as low as -40°C and is therefore suitable for all year touring.

When installing gas cylinders it is very important that you ensure the connections on both the cylinder and the regulator are compatible. The pressure setting and capacity must be as per the manufacturer's instructions must be correct.

Cylinders should always be adequately supported and should not block the ventilation openings in the gas locker.

Care must be taken to ensure that gas cylinders do not cause damage to the fixtures and fittings located within the gas locker.

When fitting gas cylinders care should be taken to avoid damage to the hose assembly when it is connected to the cylinder.

Always turn off the gas cylinder valve(s) or inlet to the motorhome when gas appliances are not in use or when retiring to bed.

When carrying out maintenance always ensure gas sources are correctly capped off.

## SAFE USE OF GAS SUPPLY TO APPLIANCES

All gas appliances in your motorhome can have their gas supply individually isolated by turning off the relevant tap on the gas manifold. The gas manifold taps are located in the kitchen area.

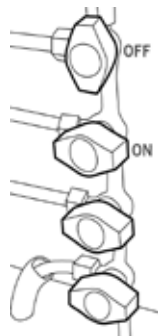

Before you travel, make sure that all gas appliances are switched off and always turn off the gas at the cylinder.

## REGULATOR

The regulator is a governing device which adapts the bottle pressure to one that suits the equipment in the motorhome.

As standard your motorhome is fitted with a gas regulator. This is located in the gas locker. The regulator has a working pressure of 30 mbar and is therefore suitable for both propane and butane.

TRUMA MONOCONTROL REGULATOR

**INTENDED USE**

MonoControl is a safety gas pressure regulator for motorhomes. The gas pressure regulator ensures a uniform output pressure of 30 mbar with a permissible inlet pressure range of 0.3 - 16 bar.

Only use gas cylinders that are mounted in their dedicated storage locker and secured using the straps provided. Never use gas cylinders located outside the motorhome gas box.

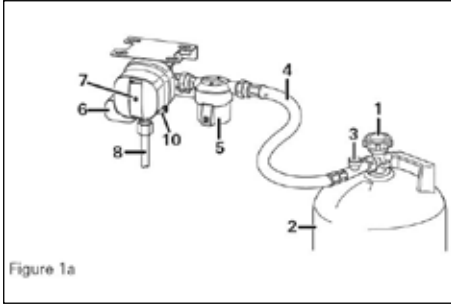

Figure 1a

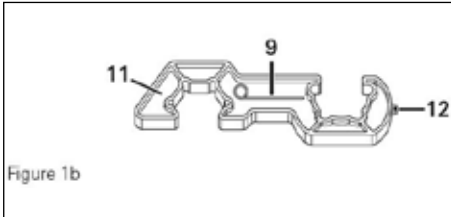

Figure 1b

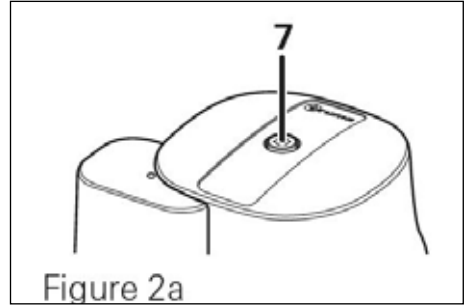

Figure 2a

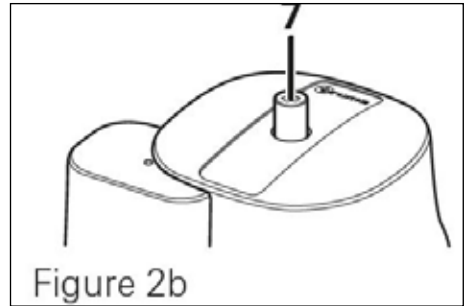

Figure 2b

- 1 = Cylinder valve
- 2 = Gas cylinder
- 3 = Hose rupture protection (if fitted)
- 4 = High-pressure hose
- 5 = Gas Filter (if fitted)
- 6 = MonoControl CS
- 7 = Yellow reset button of the crash sensor
- 8 = Steel / copper tube
- 9 = Triggering element for the crash sensor
- 10 = Screw cap (test connection)
- 11 = Screw aid a/f 23 / KF
- 12 = Torx T20 (on the screw aid)

**START UP**

- Open the gas remote switch if present.
- Connect the gas cylinder (2) and ensure that the hose connection is in perfect condition.
- Open the cylinder valve (1).
  
- If the motorhome is fitted with a Crash Sensor, press the yellow reset button to activate the regulator"



Never replace your regulator with one that does not conform to EN12864 Annex D as this does not comply with EN1949.



Never extend the hose; IT MUST NOT EXCEED 450MM.



The pressure regulating device and hoses must be replaced with new ones no more than 10 years after their date of manufacture (8 years if used commercially). This is the responsibility of the owner.



Do not use a regulator with a different operating pressure.



In the case of a connection on a pressure regulator or gas appliance which relies upon a sealing washer to maintain a gas-tight joint, it is essential to check that the washer is present and that it is correctly positioned prior to making the connection. Where the connection relies on a metal to metal seating or bull nose connection to obtain a gas-tight joint it is essential that the mating surfaces are clean and undamaged. In no case should a damaged valve or connection be used.



Residual gas may be present when carrying out any task on gas cylinders. Do not smoke and avoid open flames or any source of ignition.

## GAS SYSTEM MAINTENANCE

The complete gas installation on a motorhome should be inspected at least once per annum and as necessary according to usage. Hoses should conform to BS 3212. It is advisable to replace hoses annually and in any case no later than the expiration date marked on the hose.

Check the following:

- Flexible gas hoses for deterioration. Renew if necessary or renew no later than the expiration date marked on the hose.
- The tightness of seals around joints and connections.
- Make sure that each gas appliance is working efficiently to the recommendations of the appliance manufacturer.

- Always ensure that the gas system is inspected at least every 12 months by a qualified person.

Always use approved products when replacing parts.



Please ensure that the hose and O-ring are correctly installed and not damaged. Ensure mating surfaces are clean.

## CHANGING THE LPG CYLINDER

Ensure all gas appliances are turned off prior to changing the bottle. Always change gas containers in the open air to ensure appropriate ventilation.

Please use the spanner provided to attach and remove the high pressure hose. Ensure you only use the correct type of cylinder.

1. Extinguish any flame or source of ignition.
2. Close the empty gas cylinder's gas valve.
3. Remove the high-pressure hose from the gas cylinder.
4. Attach the high-pressure hose to the full gas cylinder.
5. Open the cylinder's valve.
6. Press the hose rupture protection.

## HOSE REPLACEMENT

1. Close gas cylinder's valve.
2. Remove the high-pressure hose from the gas cylinder and from the regulator inlet.
3. Screw a country-specific high pressure hose to the MonoControl CS inlet and to the cylinder.
4. Open the gas cylinder.
5. Check the hose connection at the cylinder valve and also at the MonoControl CS inlet for leaks after every modification.
6. After making changes always check the connection to the cylinder for leaks using a leak detector spray or a soapy solution.



We recommend that the gasket (part number 50020-76300) is replaced with every hose change. This will be provided by your supplying dealer upon replacement of the hose.



## GAS LEAKS

If a smell of gas becomes apparent, the supply should be turned off at the cylinder immediately. Extinguish all naked flames and sources of ignition.

- Ensure the gas valve is turned off.
- The strong unpleasant smell of gas means that a leak has been detected.
- Check that gas is not escaping from an unlit appliance.
- Never check for leaks with a naked flame. Check all pipe joints by using a washing-up liquid solution - the gas will bubble in the area of the leak.
- Isolate the supply, preferably at the cylinder, and seek professional help.
- Do not operate electrical switches.
- Open all doors and windows to allow any gas to escape. Butane/propane gas is heavier than air so any escaping gas will therefore collect at a low level - ensure floor vents remain unobstructed.
- If the leak was internal, evacuate.
- If the gas leak cannot be stopped, remove the cylinder to a safe place in the open air in an upright position away from drains and any source of ignition. Immediately contact a competent service engineer.
- When being stored always keep gas cylinders outside (and protected against frost). If they must be kept inside make sure they are well away from heat and near to a drop vent.
- If taps are too stiff to operate or appear to be a source of leakage, call in a competent installer to rectify. LPG taps require a special grease.
- If in doubt always ask a qualified engineer.

## VENTILATION

Carbon monoxide is odourless, colourless and tasteless and will rapidly cause unconsciousness and death with little or no warning prior to collapse. Under no circumstances should the motorhome's ventilation be blocked or obstructed in any way. High-level ventilation is via the rooflights. The low-level ventilation is achieved via the vents located in the floor.

The exterior gas vent/flue should be kept free of any obstructions including but not limited to dust, leaves, dirt and/or personal items. Inspect

regularly. Use a brush and soapy water to clean when needed. It may be necessary to remove the weather shield to gain access for cleaning.



Safety ventilation shall in no circumstances be obstructed, even partially.



Flues which terminate below the floor require that free evacuation of the products of combustion is always maintained. At least three sides of the underfloor space shall always be kept open and unobstructed especially by snow. No additional opening in the floor should be created.

## GENERAL SAFETY NOTES

The pressure of external LPG supply to external supply plug shall not be less than 0,3 bar nor greater than 0,5 bar.

The operating pressure for the gas supply is 30mbar (or 28mbar butane/ 37mbar propane) and must correspond to the operating pressure of the appliance (see name plate).

During initial operation of a brand new appliance a certain amount of fumes and a slight smell may be noticed. Immediately run the heater at maximum output and ensure adequate room ventilation.

If the burner makes an unusual noise, it is likely that the regulator is faulty and it is essential to have it checked by a qualified person.

Repair jobs must only be carried out by a fully-trained expert.

All flue installations should be inspected at least once a year, throughout their entire length for integrity, of attachment, both to appliance and cowl, and for perforation due to damage or corrosion. Flues should be replaced if any sign of damage or perforation is found. It should be ensured that the replacement is of an approved type conforming to the recommendations of BS 5440-1.

Gas cylinders can have different connections. It is important to check that you have the correct hose and/or adaptor to suit your gas cylinder. Regulations no longer permit push fit hoses.

For further advice contact your motorhome retailer.

Gas cylinders that are not connected to the gas installation must be closed off at all times and fitted with protective caps.

Connections are designed to be tightened with a spanner. It is essential that a spanner of the correct size is used and that the union is firmly tightened; hand tightness is not sufficient.

When self-sealing valves are incorporated in a gas cylinder connections should be made in accordance with the manufacturer's instructions and tools should not be used.



Never use portable cooking or heating appliances, other than electric heaters that are not direct radiant type. They are a fire and asphyxiation hazard. Cookers should never be used as a heating source.



Some industrial LPG appliances operate at high pressure and require a high pressure regulator. This often has an adjusting handle on it. NEVER USE SUCH A REGULATOR ON A MOTORHOME.



Additional independent gas appliances should NOT be used inside the motorhome.



Do not operate the water heater when refuelling the vehicle and when in a fuel station.

## FIRE PRECAUTIONS

As stated in the Safety and Security section, a fire extinguisher is not provided with your motorhome. Therefore it is recommended that one is purchased of adequate size; it is recommended that a dry powder extinguisher is used only if it is likely that the leakage can be stopped by closing the cylinder valve or that the cylinder can be removed quickly.

When a fire has been extinguished, cool with water, all gas cylinders which cannot be removed. As soon as possible remove any cylinders in close proximity to the fire to a safe location.



No gas appliance should be operated whilst the vehicle is running, including the fridge in gas mode.

**TYPICAL GAS SYSTEM**

**LAYOUT**

Note: Manifold order may change

-  1. Hob isolation tap
-  2. Oven isolation tap
-  3. Fridge isolation tap
-  4. Boiler isolation tap
-  5. BBQ isolation tap (Autograph/Alliance SE)

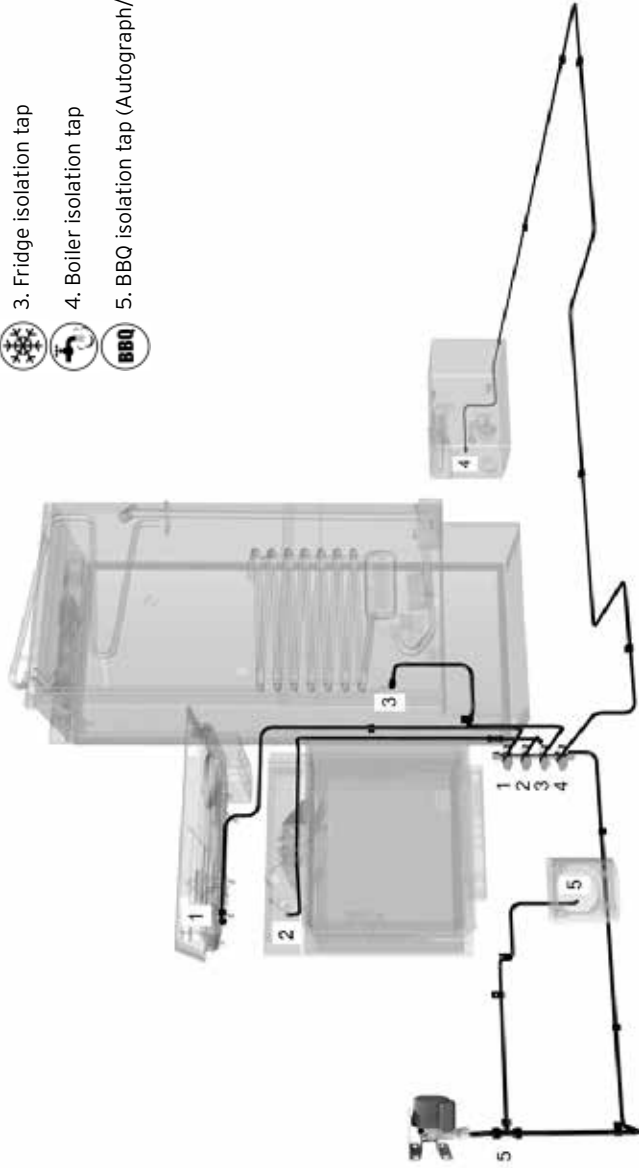

# THE ELECTRICAL SYSTEM

---

The 230 Volt Electrical System .....	51
Power Distribution Unit.....	51
The 12 Volt Electrical System.....	52
Upon Arrival At a Motorhome Site .....	52
Leaving The Motorhome Site.....	52
Generators.....	52
Leisure Battery.....	53

# THE ELECTRICAL SYSTEM

## THE 230 VOLT ELECTRICAL SYSTEM



**NEVER START YOUR MOTORHOME ENGINE WHILST HOOKED UP TO A 230V SUPPLY.** This can lead to damage to the PDU.

The electrical system in your motorhome is comprised of a 230v and 12v circuit. When connected to a mains hook up your vehicle will take its power from the 230v mains feed. All sockets and connections (including 12v) will receive power and function in the correct manner. The leisure battery and vehicle battery will also be charged.

If no mains connection is available the electrical system will run via the 12v circuit. Usage time will be governed by the amount of charge in your leisure battery (this can be checked via the Seattle control panel).



When the motorhome engine is running power to the habitation area is isolated. Therefore sockets and connections will not function unless designed to do so.

## POWER DISTRIBUTION UNIT

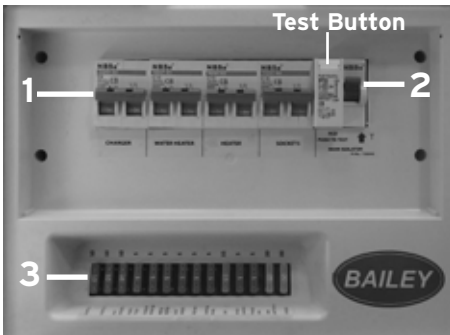

The Power Distribution Unit (PDU) is responsible for distributing power to the electrical outlets and systems throughout your motorhome. It also houses Miniature Circuit Breakers (MCD) (1) the Residual Current Device (RCD) (2) and most of the in-line fuses (3). The unit gives overload, short

circuit and earth leakage protection for the 230V electrical supply in your motorhome.

For normal operation, all switches on the unit need to be in the ON position.

In the event of an overload the MCBs “trips” and automatically moves to the OFF position. After the overload has been removed the MCB can be reset by switching to the ON position.

If an earth fault develops or a person were to touch a live piece of equipment, the leakage of current to earth should immediately operate the RCD and “trip” the main switch to its OFF position. This switch is only resettable after elimination of the fault.

To reset, operate the switch as for MCBs. Everytime you connect to a site supply the RCD should be tested to ensure correct functionality.

It is possible that all of the 230v mains electrical equipment may not operate simultaneously. Having too many appliances switched on at the same time will trip the MCB. This is a safety measure.

Many motorhome site mains hook-up points provide a maximum output of 16 amps. On some continental sites the available output may be as low as 5 amps. If your loading exceeds the site supply it may trip the site circuit breaker.

When replacing fuses you should always ensure that you replace the old fuse with a fuse that is the same type and has the same rating.



Always check the available mains output in amps with your site operator.



No appliance should be used outside while connected to an internal socket.

## THE 12 VOLT ELECTRICAL SYSTEM

Your motorhome is fitted with a dual stage power supply/charger, supplying 14.2v to your leisure battery and between 13.6/13.8v to the habitation area. This converts the 230v AC supply to 12v DC. It enables the 12v equipment in the motorhome to function and also charges the motorhome leisure battery. A fully charged leisure battery should read 12.7v on the voltmeter in the control panel. During charging the control panel will temporarily read between 14.2/13.8v.

The charger is capable of charging leisure batteries and will not overcharge. The 12V system is designed to operate with a leisure battery in circuit and should not be turned on without one connected. The 12V supply to the motorhome services can be isolated via the 12V on/off switch on the control panel. The 12V electrical system's fuses are located either in a bed box or under the fixed bed. It has 14 fuses, each having identification of their particular use. If a fuse is to be replaced it must be with one of the same rating as the one that is removed.

### UPON ARRIVAL AT A MOTORHOME SITE

1. Ensure the mains supply is suitable for your electrical installation and appliances. Check the current, voltage, frequency and polarity are correct.
2. Ensure the electrical installation will be properly earthed when connected. Never accept a supply from a socket outlet or plug that lacks a proper earth.
3. Check that any Residual Current Device (RCD) within the Power Distribution Unit (PDU) has been tested within the last month. (To test, follow steps 4 to step 9).
4. Make sure the switch at the site supply point is off.
5. Make sure the RCD is switched off.
6. Lift lid of the electricity inlet on the motorhome and insert the mains site lead. (The 230V mains inlet is located on the side of the motorhome and is identified by a lightning bolt).
7. Remove the cover from the socket outlet provided at the site and insert the mains site lead plug.

8. Turn on the site supply point (if there is no switch the power will already be live).
9. Loosely lay excess cable on the floor, not on a drum or in a container.
10. Switch on the motorhome RCD. Press the test button. The RCD should switch off, breaking the circuit to this indicates the RCD is functioning correctly.
11. Move the RCD switch to the ON position.
12. In any case of doubt consult the site owner or their agent.
13. Interior outlet sockets must only be used with approved appliances.
14. Only use suitable appliances externally.

### LEAVING THE MOTORHOME SITE

1. Switch off the site supply.
2. Switch off the motorhome RCD, then disconnect the supplied flexible cable.
3. Switch off and disconnect all portable appliances.
4. Stow mains site lead in a tidy state.

### GENERATORS

1. Switch off all appliances, all circuit breakers and the RCD.
2. Start the generator and allow to run for a few minutes to stabilise.
3. Connect the motorhome to the generator using an approved mains site lead.
4. Switch on 16amp circuit breaker.
5. Switch on the RCD.
6. Switch on the fridge (230v phase) or plug in a 230v light to one of the 13amp sockets. This is to provide a load on the generator and help remove any "spikes" in the supply which can damage the charger unit.
7. Switch on the 5 amp circuit breaker and any other appliances you require.

It is always advisable to have at least one other mains appliance switched on with the charger unit to minimise the chance of damage to it.



Do not connect the 12V output of the generator to the battery terminals.



AC ripple must not exceed 1.2v Peak to Peak.

## OVERSEAS CONNECTIONS



Connection to a mains voltage supply overseas requires particular attention.

Care must be taken when connecting to a supply abroad as the supply may have reverse polarity. Reverse polarity can lead to safety issues due to the fact that when electrical equipment is switched off it may not be electrically isolated. The only certain way of making equipment safe is to unplug it.

## MOTORHOME SERVICE SYSTEMS

A means of checking the polarity of the mains supply when overseas is useful. There are several proprietary makes of equipment available for this purpose. These can be found at [www.primaleisure.com](http://www.primaleisure.com)

## THE LEISURE BATTERY

The leisure battery is located under the floor in the motorhome in a sealed compartment. The battery compartment accommodates one battery of up to 110 amperes/ hours capacity. The battery must be placed in the tray provided in the battery storage compartment, and this must be used at all times. When fitting a second leisure battery, please ensure that it is the same type/make and capacity as the first.

A battery of not less than 60 amperes/hours capacity is recommended.

- The battery should be secured to prevent movement when in transit.
- Metal objects should not be stored in the battery box.
- DIY modifications/additions to the wiring systems are not recommended. Consult your dealer who will be pleased to carry out such work.
- Switch off all appliances before disconnecting battery.
- Negative connections should always be disconnected first and reconnected last.
- Car type battery chargers are not suitable for charging a leisure battery and may damage it.
- When you are not using motorhome fridge always ensure that the control knob is turned to the OFF position. Failure to do this will result in a flat battery due to 12V power drain from the fridge circuit relays.
- Crocodile clips should never be used to connect the battery, and terminals should be shrouded.
- Any replacement of an auxiliary battery shall be of the same type and specification as that originally fitted battery or as specified by the manufacturer.



Always switch off all appliances and lighting before disconnecting the auxiliary battery.

## BANNER LEISURE BATTERY

Bailey has chosen to fit a Banner battery to your motorhome. These batteries are designed to cope with today's increased energy demands. By choosing Banner we are assured of a first class product, fit for purpose, supplied by a leading European battery manufacturer. Banner possesses the latest ISO 9001, ISO/TS 1649 and ISO 14001 quality certification.



Never overcharge your battery. A maximum voltage of 14.7V boost and 13.8v float should be used.

## BATTERY MAINTENANCE

- Wear goggles when working with the battery.
- Keep out of reach of children.
- Keep away from naked flames.
- Prior to removal of the battery switch off all electrical systems.
- Dispose of old batteries at an authorised collection point. For a replacement unit please contact [www.primaleisure.com](http://www.primaleisure.com)
- The battery must always be kept upright without any danger of tipping.
- Your Banner battery has 4 chamber leak protection so should not leak during normal handling.
- When removing the battery always remove the negative terminal first.
- Always ensure that the battery's tray is clean.
- Never use a frozen battery or a battery in a temperature above 45° that is warm to the touch.
- Stop using the battery if it becomes hot or acid escapes.

## TAKING OUT OF OPERATION

- Store in a cool dry place (but not on a concrete floor). Never store a flat or discharged battery. Always charge before storage and monitor voltage.
- Check the battery voltage every 4 months and recharge with a suitable battery charger if it has fallen below 12.5V.
- If the battery is left in the vehicle during storage, disconnect the negative terminal.
- For long periods of storage or non-use connect the battery to a suitable long term connection charger with a float mode.



# Leisure Batteries

## with OE Pedigree



### Energy Bull

The official power supply on all Bailey Caravan and Motorhome vehicles.



### Power Evolved

The power of Banner Batteries has not only evolved through ongoing product innovation combined with world class manufacturing, but an unparalleled OE pedigree that is the backbone of the company's genetic make-up.



# Banner

THE POWER COMPANY

[www.bannerbatteries.com](http://www.bannerbatteries.com) t: 01889 571100

# SOLAR DUAL BATTERY CHARGER

---

Introduction .....	57
Function .....	57
The Charging Process Explained .....	57
Operation.....	58
Safety Instructions.....	59
Maintenance.....	60
Repairs .....	60
Technical Data .....	61

# SOLAR DUAL BATTERY CHARGER

## INTRODUCTION

The solar module/panel generates power when light is cast upon it. Full voltage is also available even if there is little light. The solar automatic charger only serves to charge 12v (24v) lead accumulators comprising 6 (12) single cells with a capacity of 50-100Ah (SDC 10) or 50-200Ah (SDC 20) (e.g. leisure battery). The preferred application fields for the automatic charger are batteries with gel, AGM (Absorbed Glass Mat) or liquid electrolyte.

## FUNCTION

The device has a modern microprocessor-controlled pulse with a modulated three-phase charging characteristic. This allows high performance combined with a light weight and small dimensions. By virtue of the high-quality electronics, it works highly efficiently. The automatic charging process preserves the device and does not overcharge the batteries. This in turn extends the service life of the batteries significantly.

It is suitable for batteries with liquid, gel or AGM technology and has a settable charging current distribution for two separate battery connections.

The device is designed for continuous operation and parallel mode. Consumers can be continuously connected, switched on or disconnected. Consumers are supplied and the batteries are charged at the same time. The consumer current here should be smaller than the solar charging current as otherwise the battery will not charge.

If the device is operated in conjunction with an external temperature sensor for the supply battery, the device regulates the charging voltage automatically depending on the battery temperature. This ensures particularly effective and gentle charging of the battery. If an external temperature sensor is not used, the device regulates the charging process based on the internal temperature sensor.



Please observe the maximum voltage and power consumption values.

## THE CHARGING PROCESS EXPLAINED

The device has electronic reverse voltage, reverse current and solar short-circuit protection. The charging current is only released if the battery is connected correctly and there is enough power available from sunlight. When a temperature sensor is used, charging takes place on a temperature-dependent basis.

### BULK PHASE

Charging with maximum available solar charging current until the required end voltage is reached.

### ABSORPTION PHASE

The charging current is kept for a period of 2 hours. At the end of this period, it changes to the float phase.

### FLOAT PHASE

The charging voltage is set to 13.8v. The charging current drops to the value necessary to compensate the self-consumption of the battery. Power is still supplied to the attached consumer units. If the consumed current exceeds the available solar charging current the charging process can no longer be maintained. If the battery voltage drops below 13.3 V, the device automatically switches to the bulk phase if there is adequate solar charging current.

### EQUALISATION CHARGING PHASE



Only for AGM and liquid electrolyte battery type

The equalisation charging phase serves to compensate the cell voltages and can reduce any sulfation. If the voltage of the battery drops below 11.1 V, it is assumed that the battery has deep-discharged. The device is switched to the equalisation charging phase for two hours. At the end of this period, it changes automatically to the float phase.

## OPERATION

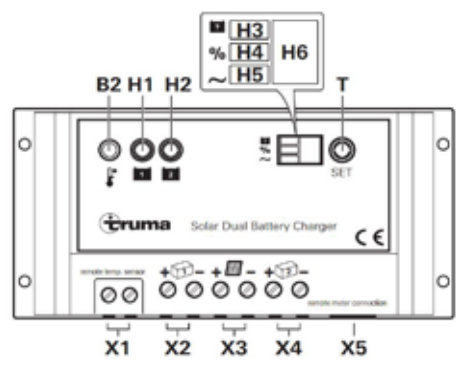

- H1 LED - Function display battery 1 (supply battery)
- H2 LED - Function display battery 2 (starter battery)
- H3 LED - Battery type - AGM, gel, liquid (liquid electrolyte)
- H4 LED - Charging current distribution
- H5 LED - PWM charging frequency
- H6 shows the values of H3, H4, H5 as numbers
- T Query / change operating mode
- B2 Internal temperature sensor
- X1 Connection for temperature sensor B1
- X 2 Connection for battery 1 (supply battery)
- X3 Connection solar module
- X4 Connection battery 2 (starter battery)
- X5 No function

The display H6 shows different system settings. Press the key (T) to switch between LED H3, H4 and H5 and display this in H6. If the key is pressed again, the system starts at LED H3 again.

## SET BATTERY TYPE

> Press (T) until LED H3 illuminates. The saved value is shown in the display (H6).

Display H6	Battery Type
1	Gel (pre-setting)
2	AGM
3	Liquid (liquid electrolyte)

## TO CHANGE SETTING

- > Press key (T) for 5 seconds until the display H6 flashes.
- > Press the key (T) to set the required value.
- > If the key is not pressed for 5 seconds, the displayed value will be saved and flashing stops.



The battery type can only be set for battery 1. Battery 2 is always assumed to be the same battery type.

## CHARGING CURRENT DISTRIBUTION

The charging current distribution between battery 1 and battery 2 can be adjusted.

> Press (T) until LED H4 illuminates. The saved value is shown in display H6.

Display H6	Battery 1	Battery 2
0	0%	100%
1	10%	90%
2	20%	80%
3	30%	70%
4	40%	60%
5	50% (pre-setting)	50%
6	60%	40%
7	70%	30%
8	80%	20%
9	90%	10%

## TO CHANGE SETTING

- > Press key (T) for 5 seconds until the display H6 flashes.
- > Press the key (T) to set the required value.

> If the key is not pressed for 5 seconds, the displayed value will be saved and flashing stops.



During the normal charging process, the device divides the charging current between battery 1 and battery 2 as set. Once the battery 1 is fully charged, all the charging current is fed to battery 2, regardless of the set value. If the voltage of battery 1 drops, the charging process starts again. If only battery 1 is connected, the entire charging current is supplied to this battery regardless of the set value.

**PWM CHARGING FREQUENCY**

The pulse frequency of the device can be set here. This may be changed to reduce possible interferences.

> Press (T) until LED H5 illuminates; the saved value is shown in display H6.

Display H6	PWM charging frequency
0	25 Hz (pre-setting)
1	50 Hz
2	100 Hz

**To CHANGE SETTING**

- > Press key (T) for 5 seconds until the display H6 flashes.
- > Press the key (T) to set the required value.
- > If the key is not pressed for 5 seconds, the displayed value will be saved and flashing stops.

**FUNCTION DISPLAY/TROUBLESHOOTING**

LED H1 (H2) shows the status of battery 1 (battery 2).

**LED flashes in longer intervals**

Check connections from the device to the battery and solar module, ensure that they are connected to the right terminals. Test the fuse, solar module and the battery.

**LED flashes**

The battery is fully charged.

**LED shines:**

The battery is being charged.

**LED flashes in short intervals:**

The battery is not being charged. If necessary replace as the battery may be faulty.

**LED does not shine:**

Battery not connected or over-voltage.

If this does not solve the problem, please contact the Truma Service Center.

**SAFETY INSTRUCTIONS**



Failure to observe any of the below safety warnings may lead to serious injury or even death.

The solar module generates power when light is cast on it. The full voltage is also available even if there is little light. The open circuit voltage may be twice as high.

- Do not touch any live parts.
- Do not step on or place any loads on the solar module.
- Do not use a damaged solar module.
- Only qualified technicians may assemble and connect electrical devices.
- Never switch solar modules in sequence, as this could lead to higher voltages.
- Liquid electrolyte batteries can create explosive gases, so ensure there is adequate ventilation. Check the liquid level at regular intervals.
- Overcharging can damage your battery; check the technical data for your battery to avoid this.
- Equalisation charging increases the charging voltage. This may damage the consumer unit. Ensure that all consumer units are designed for such voltages.
- Only operate devices with undamaged casings and cables. Ensure the cables are installed safely. Do not pull on the cables.
- Persons may be exposed to a risk of high voltage if the front glass or lamination on the rear side is damaged.
- Batteries may generate explosive gases during charging and operation. Keep away from flames and ignition sources. Ensure there is sufficient ventilation in the battery chamber.

## MAINTENANCE

The power supply must always be disconnected before performing any maintenance work. Any light should be prevented from being cast upon the panel(s). Therefore you should completely cover the panel(s) before attempting any maintenance. Clean the device with a dry, lint-free cloth.

## REPAIRS

Do not repair or modify the device. Please contact your Bailey retailer.

The below are not suitable for charging:

- 6V batteries or 6V lead accumulators
- Non-rechargeable batteries
- Nickel-cadmium batteries



If batteries with a rated voltage of 6V are charged with the device, gassing occurs immediately. An explosive gas may be created.

The device is only suitable for regulating solar modules. Do not connect any other voltage sources (e.g. main voltage 230V) to the device. This may destroy the device and/or sources.

Further information can be found on the Truma website: [www.truma.com](http://www.truma.com).

**TECHNICAL DATA**

\* Double the values of the 12 V to work out the 24 V values.

Electrical values		
Operating voltage automatic recognition	12V	24V
Max. input voltage	30V	50V
Voltage range*	8 - 15V	
Allowed ambient temperature range	-35 °C - +55 °C	
Allowed storage temperature range	-35 °C - +80 °C	
Self-consumption	4 mA at night 10 mA during charging	
PWM frequency, settable	25 Hz, 50 Hz, 100 Hz	

Currents		
	SDC 10	SDC 20
Max. module current constant at 25 °C	10 A (approx. 150 Wp)	20 A (approx. 300 Wp)
Max. output current constant at 25 °C	10 A	20 A
Battery capacity	50 - 100 Ah	50 - 200 Ah

Charging voltage			
Battery type, settable	Gel	AGM	Liquid
Absorption phase *	14,2 V	14,4 V	14,6 V
Float phase *	13,8 V	13,8 V	13,8 V
Equalisation charging phase *		14,6 V	14,8 V
Bulk phase reconnection voltage *	13,3 V		
Maximum charging voltage *	16,6 V		
Temperature compensation *	-30 mV / K		
Temperature sensor (measuring range)	-40 °C - +125 °C		

Mechanical values		
	SDC 10	SDC 20
Protection type	IP 30	
Installation	Wall mounted	
Weight	200 g	230 g
Connection terminals	4 mm <sup>2</sup>	
Dimensions L x W x H	154 x 76 x 37,5 mm	
Humidity (not condensing)	95 %	

# THE HEATING SYSTEM

---

Alde Heating System .....	63
Operating Instructions .....	63
Gas Heating.....	63
Electric Heating .....	64
Domestic Hot Water .....	64
Draining Fresh Water .....	65
Heat Transfer Fluid.....	65
Filling .....	65
Central Heating .....	66
Circulation Pump .....	66
Bleeding Air From The System .....	66
Air Lock.....	67
LPG Safety.....	67
Flue .....	68
Maintenance.....	68
Winter .....	69
The Alde Control Panel - Controlling The Heating System.....	71
Truma Combi 4E .....	77
Truma CP Plus Digital Control Panel.....	81



# THE ALDE HEATING SYSTEM

## HEATING SYSTEMS

### ALDE HEATING SYSTEMS

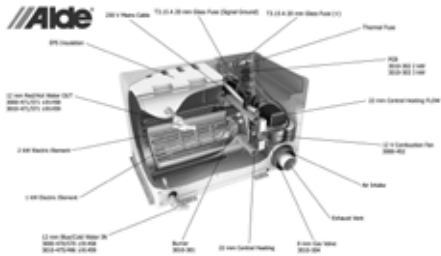

Always replace the heat transfer fluid (HTF) in accordance with the antifreeze product's lifespan. If in any doubt, replace the HTF after 5 years.

The corrosion inhibitors found in ethylene glycol antifreeze may not be cross-compatible. When topping up or replacing the HTF ensure the new antifreeze is compatible with the current antifreeze product. Read the product label or contact the product manufacturer for details.

### OPERATING INSTRUCTIONS

#### 3020 Compact High Efficiency Boiler

These instructions are approved for the Alde 3020 Compact HE Boiler fitted in motorhomes in accordance with CE 0402 no. SCO653-13 and have the E5 mark for installation in vehicles in accordance with ECE R122, no. 00 001 and R10, no. 04 166, for use in central heating and hot water systems.

The Alde 3020 Compact HE boiler must be installed or repaired by a competent person in accordance with current local regulations. In the unlikely event that your boiler develops a fault, switch off the boiler and contact Alde, or your dealer or installer.

Operating and installation instructions for the Alde control panel are supplied separately.

### BOILER DESIGN

The boiler's internal heat exchanger consists of three concentric cylinders: the combustion chamber, the central heating cylinder and the hot water cylinder.

The combustion chamber is made from aluminium and is divided into two halves by a baffle plate, with the burner head located in the top half and the flue gases venting through the bottom half.

The combustion assembly is fixed to the end of the internal heat exchanger. It consists of the burner, combustion fan, gas valve, air intake, exhaust ducts and gas line.

Two electric heating elements are sealed inside the central heating cylinder, one for 1kW, one for 2kW.

### DESCRIPTION OF FUNCTIONS

#### GAZ HEATING

When gas heating is set to "On" the combustion fan starts to revolve. Once the correct speed is achieved (in RPM), a signal is sent to the PCB (printed circuit board) for the burner to be lit. The gas valve opens passing gas and the ignition module on the PCB generates sparks at the electrode on the burner head.

When the burner ignites a flame supervision device (FSD) signals the ignition module to cease sparking. The burner fires until the boiler or room thermostat reach the set-point.

Should the burner flame out unexpectedly, the FSD detects this and attempts to reignite (for about 10 seconds), before shutting down and raising a fault code.



Listen carefully to the ignition sequence of the boiler. You should hear the whirr of the combustion fan, the clunk of the gas valve and the tick-tick of the ignition module.

### ELECTRIC HEATING

When electric heating is set to 1, 2 or 3kW relays on the PCB trip, feeding 230v supply to the electric heating elements. These are controlled by the same programme as the gas heating.

### DOMESTIC HOT WATER

The combi-type boiler automatically produces hot water. Heat is emitted from the central heating cylinder into the hot water cylinder. If the hot water cylinder is empty the air is heated but no damage can result. In a good summer, lower the desired temperature on the control panel to around 10°C. The central heating will not circulate (unless the temperature drops to 10°C), but you will still have hot water.

- The boiler must not be switched on if there is no heat transfer fluid (HTF) in the system.
- Always drain down the fresh water system if there is risk of frost.
- You may continue to use the boiler with no freshwater in the system, as required; no damage can result.
- Always replace the HTF in accordance with the antifreeze product's lifespan.
- If in any doubt, replace the HTF after 2 years.
- Only sterilise the fresh water system with a product suitable for stainless steel.
- Do not place stowage on or around the boiler.
- Do not position awnings, tents or other enclosures around the flue terminal.
- Do not obstruct the flue. Be careful not to flood the flue when washing the vehicle.
- The gas heating must not be used when refuelling the vehicle at the service station or related facility.

Being a combi-type boiler, the Alde 3020 Compact HE has an integrated stainless steel hot water cylinder that holds approximately 8.4 litres of fresh water.

The boiler can produce around 12 litres of 40°C warm water per 30 mins (at a cold water

temperature of 10°C). If only the electric heating is used, this capacity is slightly reduced.

The hot water should not be used for drinking or cooking.

Always flush out the hot water cylinder before use, especially when it has stood empty for some time.



Any steriliser products should be suitable for use with stainless steel.

Avoid steriliser products containing sodium hyperchlorite as these will cause severe corrosion damage to the hot water cylinder which is not covered under warranty. Read the product label or contact the product manufacturer for details.

When the hot water cylinder is in continuous use, it should be drained and refilled once a month. This recreates the air cushion in the hot water cylinder that absorbs pressure surges.



If continuously using the hot water cylinder in a hard water area, fit an in-line scale inhibitor to minimise the effects of limescale.

The target hot water temperature is greater than 50°C in normal operation to prevent the growth of Legionella. The hot water will be heated to the maximum achievable temperature at the time. This allows the hot water to achieve disinfection temperatures and increases warm water performance. If scalding hot water temperatures are a concern thermostatic mixing valves (TMVs) can be fitted.



Alde recommends fitting the 3102-002 high temperature TMV.





Always drain down and completely empty the hot water cylinder when there is risk of frost, unless the vehicle is explicitly stated to be self-winterising by the vehicle manufacturer.

Failure to drain the hot water cylinder when there is a risk of frost may result in frost damage, which is not covered under warranty.

**DRAINING FRESH WATER**

**OPENING MANUAL SAFETY VALVE/DRAIN VALVE**

Closed



Open



- Switch off the water pump.
- Open all water taps, showers, etc.
- Open the safety/drain valve by lifting the yellow tab.

The system will drain directly below the vehicle.

- Check that all water has emptied out (7-10 litres). Leave the valve in the open position until the next time the hot water cylinder is used.

Check that the breather valve is allowing air to enter the hot water cylinder when it is being drained, and that the clear plastic hose is not obstructed.

Breather Valve

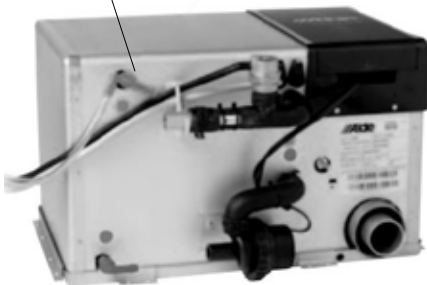

**HEAT TRANSFER FLUID**

The central heating system is filled with heat transfer fluid (HTF), a solution of 50% ethylene glycol antifreeze and 50% water.



The boiler must not be switched on if there is no HTF in the system.



The antifreeze manufacturer will have a maximum water hardness recommendation. Read the product label or contact the product manufacturer for details.

Alde recommends antifreeze meeting VAG G12++ or G13 specification, and deionised water (0 ppm).

50:50 ethylene glycol antifreeze and water will protect against frost down to -35 to 37°C. A refractometer and/or hydrometer can be used to measure the strength of the antifreeze solution.

Corrosion protection will vary depending on the lifespan of the antifreeze. Contact the product manufacturer for details.



Always replace the HTF in accordance with the antifreeze product's lifespan. If in any doubt, replace the HTF after 5 years.

The corrosion inhibitors found in ethylene glycol antifreeze may not be cross-compatible. When topping up or replacing the HTF, ensure the new antifreeze is compatible with the current antifreeze product. Read the product label or contact the product manufacturer for details.



As a rough guideline, blue and red antifreeze products are not compatible with each other, but VAG G12++ and G13 spec antifreeze (purple/magenta) is compatible with both. Failure to fill with suitable HTF may result in severe damage to your Alde system, which is not covered under warranty.

**FILLING**

The central heating system is filled with HTF through the expansion tank either by hand or by using the Alde service pump. Any containers used for handling or storing the HTF should be

checked first and must be visibly clean to avoid introducing contaminants or foreign objects into the system.

Alde recommends using the Alde 1900-811 or 839 twin-motor service pump to fill the system. To fill the system by hand, unscrew the expansion tank cap (Fig. 1 [R]) and lift the circulation pump (Fig. 1 [S]) out of the tank (if applicable).

Carefully pour the HTF into the tank, and repeat until the fluid level is about 1 cm above the MIN mark when cold.

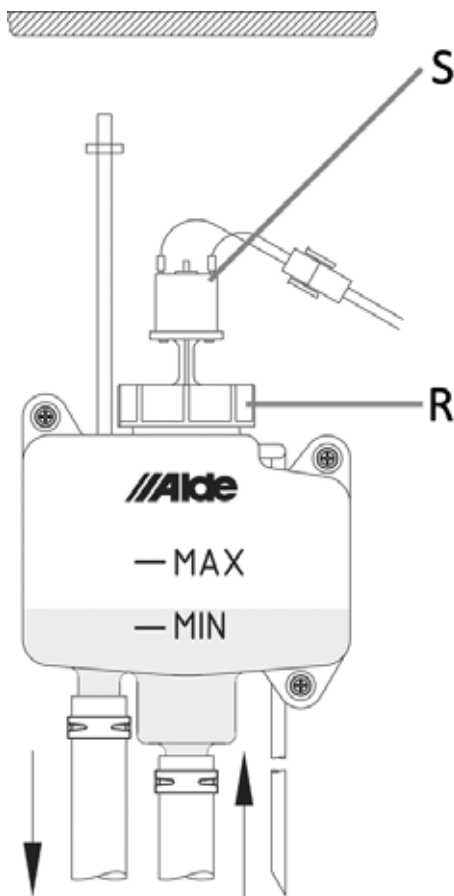

Fig. 1

#### CENTRAL HEATING

The boiler is set to an upper limit temperature of 85°C, i.e. the temperature of the heat

transfer fluid (HTF) as it circulates around the pipes, radiators, convector etc.

To ensure the best performance from hydronic heating, air must be able to circulate freely around the back of the furniture (Fig. 2). Air vents, cut into the top and bottom of the furniture must be unobstructed by carpets, cushions, or stowage etc.

The full length of a convector should be ventilated for best performance.



Use gas and electric heating simultaneously for the best performance. The boiler will only use as much energy as is needed, and is 93% efficient on a SEDBUK (seasonal efficiency of domestic boilers in the UK) based test.

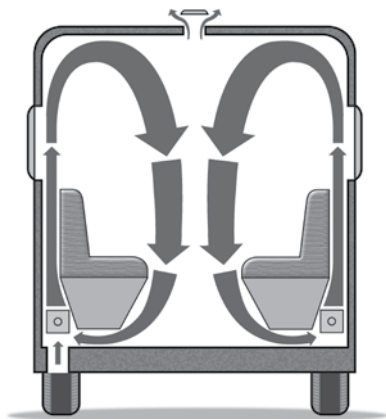

Fig. 2

#### CIRCULATION PUMP

A pump is used to circulate the HTF around the central heating system.

#### BLEEDING AIR

The HTF will contain some air. This is unavoidable. Air bubbles can also be introduced when the system is filled.

In a newly-filled central heating system you will need to bleed air from the bleed points to ensure best performance. There is an automatic air bleed valve on the boiler. There is also an air vent on the expansion tank.

Where the pipes step up and down, and on radiators and towel rails, air will accumulate at high points and become trapped.

#### TO BLEED THE SYSTEM

- Set the temperature to 30°C and select gas heating on the control panel.
- Set the 12v inline circulation pump on the side of the boiler to speed 5 by turning the blue speed dial clockwise, on the face of the pump motor. Speed is not adjustable if using the 12v circulation pump fitted in the expansion tank.
- After 10 mins, set the pump back to its normal running speed (3 for a motorhome).
- Now power off the Alde 3020 Compact Boiler completely, making sure that the circulation pump is not active.
- Follow the flow pipe from the boiler, and bleed the system at each bleed point.
- If Alde bleed points have been fitted, these are metal bleed screws mounted on black EPDM rubber connectors (Fig. 3). Have a cloth in hand. To open, turn the screw anti-clockwise between thumb and forefinger. Air will hiss out. When fluid trickles out, close the bleed screw and mop up fluid with the cloth.
- Move on to the next bleed point and repeat, until all bleed points have been attended to.



Fig. 3

#### AIR LOCK

If enough trapped air accumulates at one point an air lock can result and prevent the circulation of hydronic heating.

A ramp or steep slope can be used to raise one end of the vehicle causing the trapped air to shift around the system. Repeat the full bleed procedure. To clear a stubborn air lock in under 15 minutes, an Alde-certified service agent can use the Alde 1900-811 or 839 twin-motor service pump.

#### 230v ELECTRIC

The Alde 3020 Compact Boiler has two 230v electric heating elements outputting 1050W and 2100W or 3150W combined. Drawing 5amps, 9amps and 14amps respectively. 230v breakers, fuses, fused spurs and isolator switches should be rated for 16A.

Before using electric heating, check the current limit on the electric supply you are hooking up to.

6A limit, only use 1kW electric heating.

10A limit, use 1-2kW electric heating.

16A limit, use 1-3kW electric heating.



If the electric supply has unstable voltage the amperage will also fluctuate.



Alde recommends fitting the 3010-246 load monitor allowing you to set a limit on the current drawn by the vehicle and the electric heating to automatically accommodate it.

#### LPG

LPG (liquefied petroleum gas) has two main variants, propane and butane gas. The gas heating in your Alde 3020 Compact Boiler can use propane or butane gas as a fuel. Many LPG fuels contain a mixture of propane, butane and other additives.

BS 5482 Part 1 states, 'For butane cylinders, satisfactory service might not be obtained at temperatures of less than 10°C. The most suitable temperature range is from 13°C to 30°C. For temperatures less than 13°C, the use of propane should be considered'.

For this reason, Alde recommends using propane gas for all year round gas heating. LPG cylinders contain both gas and liquid forms. When the cylinder is filled, high pressure transforms the gas into liquid. The liquid reverts to gas when the valve on the cylinder is opened.

LPG is a flammable gas. It can be a fire and explosion hazard if stored or used incorrectly. Store cylinders vertically and securely, to prevent them from toppling.

Do not mount your LPG cylinder horizontally or use liquid phase gas cylinders. Liquid-gas explosion may result. Read the product label or contact product manufacturer for details. LPG is heavier than air. Should a gas leak occur, floor vents in a motorhome should allow the gas to escape from the vehicle. For this reason, always ensure floor vents are unobstructed.



The boiler compartment contains the gas connection, floor vents and the flue hoses. Do not place stowage in the boiler compartment.

In the event of a gas leak, or if you smell gas:

- Extinguish all naked flames.
- Open all doors and windows.
- Close all gas valves, including the valve on the cylinder.
- Do not smoke.
- Do not operate any electrical appliances or switches.
- Arrange for immediate inspection of the gas system by a competent person in accordance with current local regulations.

LPG from the cylinder is reduced in pressure by a regulator, and is supplied to the boiler at low pressure (30mbar). Never use an unregulated high pressure supply.

Where oil and dirt in the gas supply are a concern, gas filters should be fitted to prevent blockage of the boiler gas valve.

NB: Gas heating must not be used while driving your vehicle. Current local regulations must be adhered to.

## FLUE

The burning of LPG produces CO<sub>2</sub> (carbon dioxide), a non-toxic asphyxiant gas. Avoid inhaling exhaust flue gas. Exhaust flue gas can also cause possible burns and poisoning.



Do not position awnings, tents or other enclosures around the flue terminal.

Air supply is essential for clean combustion. The air intake is located in the flue terminal. For best performance the flue terminal should be well vented. If you intend on leaving the gas heating unused for a substantial period of time ensure the flue terminal is covered to prevent blockage of the flue.



Do not obstruct the flue. Be careful not to flood the flue when washing the vehicle.



The gas heating must not be used when refuelling the vehicle at the service station or related facility.

## MAINTENANCE

There is no manufacturer's service requirement for the Alde 3020 Compact Boiler itself. The installation of the boiler should be inspected annually for gas safety.

LPG hoses should be regularly checked for signs of damage and should be replaced, at maximum, after 3 years of use.

Bleed air from the system when newly filled, when the vehicle has been standing unused for a period, and before departing on holiday.

The fluid level in the expansion tank should be about 1cm above the MIN mark when cool. The heat transfer fluid (HTF) should be topped up if below this level, to prevent a break in circulation. Only top up with compatible HTF.

Always replace the HTF in accordance with the antifreeze product's lifespan. If in any doubt, replace the HTF after 2 years.

Failure to maintain the condition of HTF may result in frost and/or corrosion damage, and is not covered under warranty.

When the hot water cylinder is in continuous use, it should be drained and refilled each month. This recreates the air cushion in the cylinder that absorbs pressure surges.

### WINTER

When camping in the winter always ensure the flue terminal remains unobstructed by snow and ice. Extensions for roof flue terminals and condensate spouts for side flue terminals are available from Alde.

Check the strength of the HTF with a hydrometer and/or refractometer. It should measure 50% ethylene glycol antifreeze or -35 to 37°C.

The central heating can still be used with no fresh water in the system. The air in the hot water cylinder is heated but no damage can result.



Always drain down and completely empty the hot water cylinder when there is risk of frost, unless the vehicle is explicitly stated to be self-winterising by the vehicle manufacturer

If camping in temperatures below -10°C, consider carrying spare parts in the event of an emergency. Alde recommends a 12v circulation pump for the expansion tank (with cabling), a PCB, and 4-5 litres of ready to use antifreeze. These spare parts should be kept well insulated and in the warmest part of the vehicle, for example, in the wardrobe near to the expansion tank pipes.

If storing the vehicle for winter ensure the flue terminal is covered to prevent blockage of the flue.

If using the light duty 12v circulation pump in the expansion tank do not leave the central heating on over winter even with a low desired temperature set.



Air the vehicle over winter without wearing out the light duty pump. Use the programmable Alde control panel to automatically heat the vehicle for 24 hours, once a week.

### TROUBLESHOOTING

The Alde control panel will display any error messages.

The system is completely dead/the control panel is blank:

- Check the 20mm T3.15 amp glass fuse in the boiler. This is located under the lid of the black plastic service hatch in a green plastic fuse holder.
- Check the 12v supply to the boiler, it should be above 12v.
- Check the 12v cable is plugged into the boiler. Check the cable is plugged into the Alde control panel.

The boiler will not ignite on gas:

- Check the gas cylinder is full. Try a different gas cylinder ensuring it is propane gas.
- The system may not need to use gas heating if also using electric heating.
- The fluids in the boiler may already be at operating temperature.

The boiler will not heat on 230v electric:

- Check that any 230v isolator switches are on (they will often have an LED indicator).
- Check the 230v supply to the vehicle.
- The fluids in the boiler may already be at operating temperature.

No hot water:

- Check that "hot water ignore" is not activated on the Alde control panel.
- Check that constant pumping is not activated on the Alde control panel.
- Check for other conflicting settings on the Alde control panel.
- Check the freshwater supply and water pump.

No central heating:

- Bleed the system of air.
- Check the fluid level in the expansion tank.
- Check that the circulation pump is responding.
- Check that "hot water boost" is not activated on the Alde control panel.
- Use gas and electric heating.
- Check that vents in the furniture are not obstructed.
- Check the condition of the heat transfer fluid.

Most vehicles will reach a comfortable temperature within an hour, in non-extreme conditions.

If problems persist, please contact Alde, or your dealer or installer.

**WARRANTY**

Alde undertakes to rectify any manufacturing defect or early component failure through normal use that occurs within 12 months of the installation date.

If your Alde boiler develops a fault, your first action should be to contact your Bailey retailer or installer, as they will be familiar with your installation and vehicle, and how to make a claim under warranty.

Alde International (UK) Ltd  
Huxley Close  
Park Farm South  
Wellingborough  
Northamptonshire  
NN8 6AB

Tel. +44 (0) 1933 67765

[www.alde.co.uk](http://www.alde.co.uk)



## ALDE CONTROL PANEL

### QUICK START GUIDE

This quick start guide allows end users to confidently use the core features of their Alde control panel. See the operating and installation instructions for the Alde control panel for more details.

### STARTING THE SYSTEM



Both the control panel and boiler are off.



To start the system, press the Power button on the control panel.

### STANDBY SCREEN

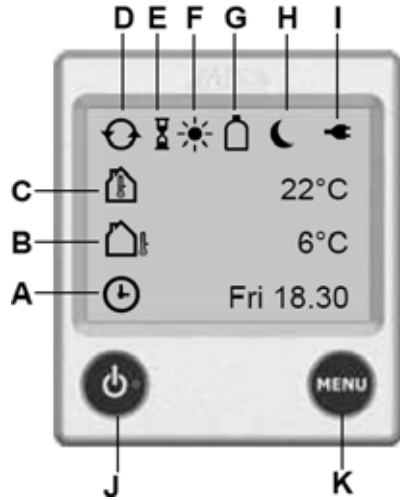

The Standby Screen is displayed after the Splash Screen. This screen contains useful information about the status of your heating system.

NB: If Standby Screen is set to "Dark" in Backlight settings the Standby Screen will not be displayed. The screen will stay dark unless touched.

- A. Clock is enabled.  
Day of the week and time shown.
- B. Outdoor temperature  
Optional outdoor temperature sensor required.
- C. Room temperature  
Measured at the control panel.  
[Optional discrete room temperature sensors available.]
- D. Central heating circulation pump is active.
- E. Delayed Start/Cycle is enabled.
- F. Day Mode active.
- G. Gas Cylinder Status  
Full/empty and active EisEx shown.  
[Additional accessories required.]
- H. Night Mode active.  
230 V supply.
- J. Power button.
- K. Menu button.

## MAIN MENU

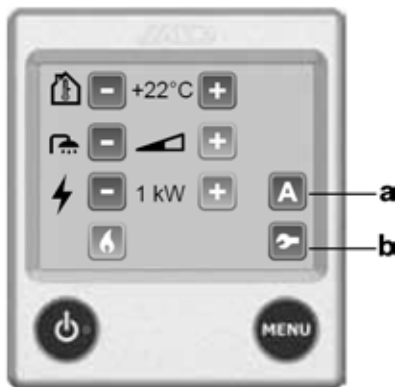

## DESIRED ROOM TEMPERATURE



To access the main menu at any time press the menu button.

- a. What's Activated Menu (not displayed if no activated functions are detected).
- b. Settings Menu.

The desired room temperature can be set from 5°C to 30°C, in 0.5°C increments.

1. The current desired room temperature is displayed.
2. Adjust by pressing plus or minus button.



If Day or Night Mode are active the temperature cannot be adjusted. The plus and minus buttons will be greyed out.



The World Health Organisation recommends a room temperature of 18-24°C for healthy living.

**HOT WATER IGNORE**

Volume bar empty. No attempt is made to heat hot water specifically. This saves energy when the fresh water is drained down.

**HOT WATER NORMAL**

Volume bar half full. Hot water is heated to greater than 50°C. NB: If circulation pump is set to Continuous, this option will not be available.

**HOT WATER BOOST**

Volume bar full. Central heating circulation is disabled for 30 mins. Hot water is heated to greater than 65°C. After 30 mins the system reverts to Hot Water Normal. Adjust by pressing plus or minus button.

The Alde boiler stores 8.4 litres of hot water as standard. If the hot water cylinder is empty, the air is heated but no damage can result.



If Day or Night Mode's Hot Water Ignore is active the hot water cannot be adjusted. The plus and minus buttons will be greyed out.

## ELECTRIC HEATING



Check that 230v supply is displayed on the Standby Screen. The Alde boiler is programmed to use power economically and there are times when it may use no power at all, even if set to 3kW.

- Select Off, 1, 2 or 3kW electric heating. More power equals better performance, but may be restricted by the current (amps) limit on the electric hook-up.
- Adjust by pressing plus or minus button.

Max current draw from 230v supply is 4.5A on 1kW, 9A on 2kW, 14A on 3kW. If the electric supply has unstable voltage, the amperage will also fluctuate.

## GAS HEATING



The Alde boiler is programmed to use power economically. The gas burner has two stages, shifting dynamically between low or full flame. There are times when it may use no power at all, even if gas heating is selected.

- Press the Flame button to select gas heating. Green is on, blue is off.

Use both gas and electric heating for best performance.

## SHUTTING DOWN THE SYSTEM

To save energy, the control panel only updates the boiler after the last adjustment is made. Wait 10 secs before shutting down the system to ensure the boiler is updated. Press the Power button again. The screen goes dark, the green LED is unlit. The system is off.

## SETUP

Most UK installations do not need setting up in the Settings Menu, and use default factory settings.

## RESTORE DEFAULT FACTORY SETTINGS

Before using the system for the first time, restore default factory settings. Your control panel may have been tested by the dealer or installer, and some settings may have been changed.

Press Tool button to access the Settings Menu (bottom right in Main Menu). Press down arrow, until Reset button is displayed. Press the Reset button to proceed.

## SETUP EXPANSION TANK PUMP

To use the 12v circulation pump in the expansion tank, you must set it up. This is not a default factory setting.

NB: Under factory settings, the system will use the 12v inline circulation pump by default. Press Tool button to access the Settings Menu (bottom right in Main Menu). Press down arrow, until Circulation Pump button is displayed. Press Circulation Pump button, select Expansion Tank Pump to proceed.

## SET UP ANTIMICROBIAL FUNCTION

To actively kill Legionella, set up the Antimicrobial function. At 2:00 every night, the hot water will be heated to over 65°C for 30 mins. This further reduces the risk of Legionella.

Press Tool button to access the Settings Menu (bottom right in Main Menu). Press down arrow, until Antimicrobial button is displayed. Press Antimicrobial button to proceed.

## SETUP STANDBY SCREEN FOR BEDTIME

The backlight on the Standby Screen can be disturbing if the control panel is visible from your bed. It can be inverted for white text on

black background.

Press Tool button to access the Settings Menu (bottom right in Main Menu). Press down arrow, until Backlight button is displayed. Press Backlight button, select Inverted to proceed.

## MAINTENANCE

The Alde control panel requires no maintenance, other than cleaning of the screen as needed. Use a microfibre cloth to clean the touchscreen.

NB: Consider removing the Alde control panel over winter, if the vehicle is to be kept in storage and is susceptible to damp.

## TROUBLESHOOTING

Any error messages will be displayed on the Standby Screen. Error messages can be cleared by switching off 12v supply to the boiler for 10 secs.

The system is completely dead/the control panel is blank:

Check the 20mm T3.15Amp glass fuse in the boiler. This is located under the lid of the black plastic service hatch, in a green plastic fuse holder.

Check the 12v supply to the boiler, it should be above 12v.

Check the 12v cable is plugged into the boiler. Check the cable is plugged into the Alde control panel.

Panel failure 1 & and Panel failure 2:

Moisture is trapped in the control panel. Remove the Alde control panel from the vehicle and air in a warm, dry place overnight.

Gas failure

Out of gas or gas is not igniting. Check the gas cylinder is full. Try a different gas cylinder, ensuring it is propane gas.

Overheat red fail or Overheat blue fail:

Bleed the system of air. Check the fluid level in the expansion tank. It should be 1cm above min mark when cool. Check the circulation pump is responding. Wait 15 mins for the fluid to cool down.

**Overheat PCB:**

Failsafe in boiler has triggered. Check the fluid level in the expansion tank. It should be 1 cm above the Min mark when cool. Check the boiler compartment is ventilated, and that the vents are unobstructed. Do not place stowage in the boiler compartment.

**Fan failure:**

Combustion fan speed too low. Bearing may be stiff after a period of disuse. Automatically clears after 5 mins. Please try again.

**Connection failure:**

Loose connection between Alde control panel and boiler. Unplug cable at the control panel and boiler, then carefully plug back in. Check there is slack on the cable at the control panel, but not excessive weight from free-hanging/unmanaged cable.

**Window open:**

Optional window sensor has triggered, gas heating is suspended. Automatically clears and gas heating resumes when window is closed.

**Connection fail ext:**

Break in communications between Alde control panel and daisy-chained third party control panel. Check the cable between the Alde control panel and third party control panel.

**Low battery:**

12v supply to boiler has dropped below 10.5v, possibly causing system brownout. Automatically clears when 12v supply reaches 11v.

**No match Heater/Panel:**

Control panel is incompatible with boiler PCB. Check control panel part number. Control panel 3020-013 is for 3020 A-series boiler, 3020-113 is for 3020 HE-series boiler.

If problems persist, please contact Alde, or your dealer or installer.

For frequently asked questions, or download all instruction manuals, please visit Alde's web site at:

[www.alde.co.uk](http://www.alde.co.uk)

**BATTERY BACK UP**

Certain Bailey models feature battery back up. This feature means the when all power to the motorhome is cut or fails the Alde control panel will maintain its memory and settings.



The back up hardware comprises of a lead and a battery holder which accepts x2 AA batteries.

**TRUMA COMBIE**

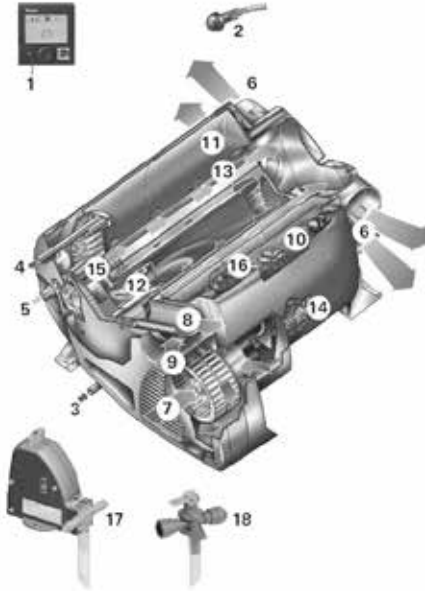

- 1. Control Panel
- 2. Room Temperature Sensor
- 3. Cold Water Connection
- 4. Hot Water Connection
- 5. Gas Connection
- 6. Hot Air Outlets
- 7. Recirculated Air Intake
- 8. Waste Gas Discharge
- 9. Combustion Air Feed
- 10. Electronic Control Unit
- 11. Water Container (10 litres)
- 12. Burner
- 13. Heat Exchanger
- 14. Power Electronics
- 15. Heating Elements 230V
- 16. Overheating Switch 230c
- 17. Frost control (Optional)
- 18. Safety Drain Valve

**FUNCTION DESCRIPTION**

The liquid gas heater Combi E is a warm-air heater with integrated hot water boiler (10 litres volume). The burner is fan assisted, which ensures that operation is problem-free, even when on the move. The unit also has heating elements for electrical operation. In heating and hot water mode the heater can be used to heat the room and heat water up at the same time. If only hot water is required, select hot water mode. At a temperature of approximately 3 °C at the automatic FrostControl safety/drain valve, the valve will open and drain the boiler.

3 different options are available for operating the unit:

- Gas mode only Propane / Butane for autonomous use.
- Electrical mode only 230 V for stationary use on campsites
- Gas and Electrical mode - mixed mode only possible in winter.



With this setting the unit automatically selects electrical operation. The gas burner is not enabled.



Repairs may only be carried out by an expert.

**HEATING AND HOT WATER MODE**

In heating and hot water mode, the unit automatically selects the required operating level according to the temperature difference between the temperature set on the control panel and the current room temperature. If the boiler has been filled, the water is automatically heated as well. The water temperature depends on the selected operating mode and the heater output.

All 3 energy selection options can be used for winter deployment.

- In gas mode the unit automatically selects the operating level that is required.
- In electrical mode outputs of 900 W (3.9 A) or 1800 W (7.8 A) can be manually preselected in accordance with the fuse protection at the camp site.

If more output is required (e.g. heating up or low outside temperatures) gas or mixed mode should be selected so that enough heating power is always available.

- In mixed mode 230 V electrical mode is preferred if the power requirement is low (e.g. for maintaining the room temperature). The gas burner is not enabled until the power requirement is higher, and is the first to switch off during heat-up operations.

#### HOT WATER MODE (WITH FILLED BOILER ONLY)

Gas mode or 230 V electrical mode is used to generate hot water. The water temperature can be set to 40 °C or 60 °C.

- In gas mode the water is heated at the lowest burner setting. Once the water temperature has been reached, the burner switches off.
- In electrical mode output of 900 W (3.9 A) or 1800 W (7.8 A) can be manually selected in accordance with the fuse protection at the camp site. Mixed mode is not possible. With this setting the unit automatically selects electrical mode. The gas burner is not enabled.

#### OPERATING INSTRUCTIONS

Read the safety instructions and operating instructions carefully before starting the unit.

The installer or vehicle owner must apply the yellow sticker with warning information, which is enclosed with the appliance, to a place in the vehicle where it is clearly visible to all users (e.g. on the wardrobe door) Ask Truma to send you stickers if necessary.

Before using for the first time it is essential to flush the entire water supply system through with clean water.

If the heater is not being used, always drain the water contents if there is a risk of frost. There shall be no claims under guarantee for damage caused by frost.

Materials in the device which come into contact with water are suitable for use with drinking water (see manufacturer declaration: [www.truma.com](http://www.truma.com) - Manufacturer Declaration).

#### ROOM THERMOSTAT

To measure the room temperature, an external room temperature sensor (s) is located within the vehicle by the control panel.



The thermostat setting on the control panel (1-5) must be determined individually depending on the heating requirement and the type of vehicle. For an average room temperature of about 23 °C we recommend a thermostat setting of about 4.

#### FILLING THE WATER HEATER

- Check the safety/drain valve within the cold water intake is closed. The lever should be in horizontal position e.

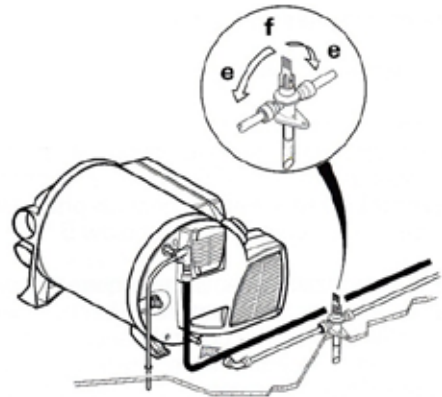

- e. Lever position "closed"
- f. Lever position "drain"

- Open the hot tap in the bathroom or kitchen, with pre-selecting mixing taps or single-lever fittings set to "hot".
- Switch on power for water pump (main switch or pump switch).
- Leave tap open to let air escape while the water heater is filling. The heater is filled when water flows out of the tap.

Residue of frozen water can prevent filling if there is a frost. The water heater can be defrosted by switching on the heater for a short period. Frozen pipes can be defrosted by heating the room.

#### DRAINING THE WATER HEATER



If the motorhome is not used during the winter the boiler must be drained prior to storage



- Disconnect power for water pump.
- Open the hot water tap in the bathroom and kitchen.
- Open safety/drain valve: Move the lever to vertical position f.

The water heater is now drained directly to the outside via the safety/drain valve. Check that the water contents have been completely drained (10 litres).

#### FILLING THE WATER HEATER (AFTER MARKET FROST CONTROL VALVE)

- Check if the rotary switch for the drain valve is set to "Operation" (parallel to the water connection) and engaged.
- Close the drain valve by pushing the button until it engages.
- When the temperature at Frost control is below about 7°C, first switch on the heater to warm the installation compartment and Frost control. After several minutes, when the temperature at Frost control is above 7°C the drain valve can be closed.
- Switch on power for water pump (main or pump switch).
- Open hot water taps in kitchen and bathroom (set preselecting mixing taps or single-lever fittings to "hot").
- Leave the fittings open for as long as it takes for the boiler to displace the air and fill up and the water to flow without interruption.

If just the cold water system is being operated without using the water heater, the heater tank also fills up with water. To avoid frost damage the boiler must be drained through the drain valve even if it was not operated.

When connecting to a central water supply (rural or city mains) a pressure reduction valve must always be installed to prevent above 2.8 bar from developing in the water heater.

#### DRAINING THE WATER HEATER (AFTER MARKET FROST CONTROL VALVE)

- **Switch off power to water pump (main or pump switch).**
- Open hot water taps in kitchen and bathroom.
- In order to check the water that is flowing out, place an appropriate container (capacity 10 litres) beneath the drain valve (Frost control) drainage muff.

- Turn the rotary switch on the drain valve by 180° until it engages, whereby the push button moves out and the drain valve opens.



Check whether all of the water in the boiler (10 litres) has been drained into the container via the drain valve.

There shall be no claims under guarantee for damage caused by frost.

#### START UP

Heating is possible with gas, electrical and mixed operation. Also with or without water.



Check to make sure the flue is unobstructed. Be sure to remove any covers that may be present.

- Turn on gas cylinder and open quick-acting valve in the gas supply line.
- Check whether the power supply fuse protection on the campsite is adequate for the 900W (3.9A) or 1800W (7.8A) that has been selected using the power selector switch.
- Fill boiler with water if necessary.
- Switch on the unit on the control panel.

#### SWITCHING OFF

- Switch the heater off on the control panel.
- The switch-off procedure may be delayed by several minutes because of internal heater operations.



Always drain water contents if there is a risk of frost.

If the appliance is not used for a long period, close the quick acting valve in the gas supply line and the gas cylinder.

#### MAINTENANCE

Only original Truma parts may be used for maintenance and repair work.

- Clean the compartment where the unit is installed at least once annually.
- Have an expert check the unit for dirt and clean it if necessary.
- The safety/drain valve must be operated regularly (at least twice annually) to remove limescale deposits and to be certain that it is not blocked.

We recommend the use of suitable commercially available products to clean, sterilise and maintain the boiler. Products containing chlorine are not suitable.

The effectiveness of the use of chemicals to combat microorganisms in the appliance can be increased by heating the water in the boiler to 70 °C at regular intervals.

- Select "Gas mode".
- Set the water temperature to 60 °C.
- Switch on the appliance.



Once the water in the boiler has reached a temperature of 60 °C, the burner will switch off. The appliance must stay switched on for at least 30 minutes and no hot water may be removed. The residual heat in the heat exchanger will heat the water up to 70 °C.

### OVERHEATING PROTECTION 230v

The 230v heating facility has a mechanical overheating switch. If the 12v power supply is interrupted during operation or during the after-run period for example, the temperature within the unit could activate the overheating protection.

To reset the overheating protection, allow heater to cool, remove connection cover and press red reset button.

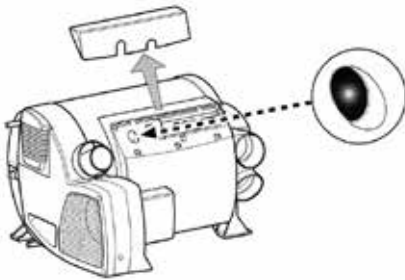

### 12v FUSE REPLACEMENT

The fuse is in the electronics beneath the connection cover.

Replace the unit's fuse only with an identical fuse.

Device fuse 10 A - low - (T 10 A)

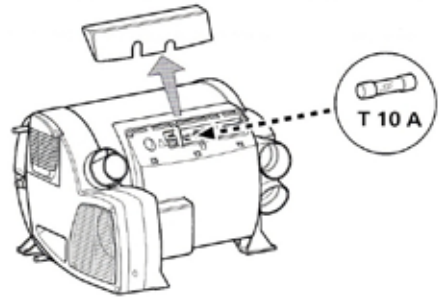

### 230v FUSE REPLACEMENT

The fuse and the power supply lines must only be replaced by an expert.

The unit must be disconnected from the mains before opening the electronic housing lid.

The fuse is in the power electronics beneath the electronic housing lid.

This fine fuse must always be replaced with a fuse of the same type: T 10 A slow, interrupting capacity H.

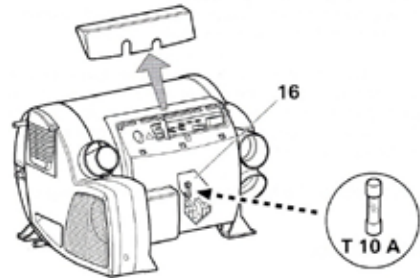

## Truma CP Plus Digital Control Panel

### SAFETY INSTRUCTIONS

- The device must only be operated if it is in perfect working order.
- Arrange for malfunctions to be rectified immediately.
- Do not repair or modify the device.
- Only allow the manufacturer or its customer service to repair a faulty device.



If the power supply to the system is interrupted for longer than 20 minutes, the time and date need to be entered again.

If the Truma Combi heater is connected to the control panel Truma CP Plus, the heater can no longer be switched via a ZUCB timer.

### DISPLAY AND CONTROL ELEMENTS



1. Display
2. Status bar
3. Menu line (Upper)
4. Menu line (Lower)
5. Display of mains voltage 230v (Power)
6. Time switch display
7. Settings/values
8. Rotary push button
9. Back button

The menus can be selected in lines (3 + 4) and settings can be made using the rotary push button (8). The display (1) has an illuminated background. The Back button (9) can be used to return from a menu.

### ROTARY PUSH BUTTON

Set points and parameters can be selected, modified and saved by tapping on it using the rotary push button (8). Selected menu items flash.



Turn to the right (+)  
Menu is paged from left to right. Increase values.  
Turn to the left (-)  
Menu is paged from right to left. Reduce values.



Clicking Accept (save) a selected value.  
Select a menu item or a change to the setting level.



Press (3 seconds) Main switch function ON/OFF

### BACK BUTTON

Pressing the Back button (9) returns you from a menu and discards settings. This means that the previous values are retained.

### START UP



Once connected to the power supply the control panel will display a start screen. This is shown after a few seconds.

If no entry is made within a few minutes, the standby screen is automatically shown again. The display shows the time and correct room temperature alternately.

### FUNCTIONS



The functions in the menu lines of the control panel can be selected in any sequence. The operating parameters are shown in the status line at the top of the screen above the black line.

The display shows the setting level. The first symbol flashes.



Previously set values/operating parameters become active again after the system is switched on.

Switch on/return to setting level

- Press the control knob/push button for longer than 3 seconds or the back button.

Switch off

- Press the control knob/push button for longer than 3 seconds.

### CHANGE THE ROOM TEMPERATURE

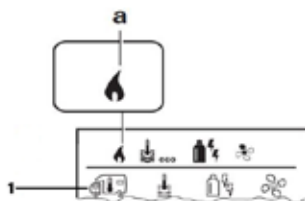

1. Use the control knob/push button to select the vehicle icon.
2. Push knob/push button to access setting level.
3. Use the control knob/push button to select the desired temperature.
4. Click the control knob/push button to confirm the value.

Temperature range 5°C-30°C (1°C steps)

a = Heater status - When visible heater is switched on.

This symbol will flash until the required room temperature is reached.

### CHANGE THE HOT WATER LEVEL

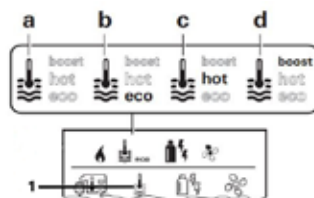

1. Use the control knob/push button to select thermometer icon.
2. Click to change to the setting level.
3. Use the control knob/push button to select the required level.
4. Click the control knob/push button to confirm the value.

a = Boiler - Warm water boiler is switched on.

b = 40° - Warm water temperature 40°C.

c = 60°C - Warm water temperature 60°C.

d = Boost - Targeted, fast heating of the content of the boiler. The water temperature is kept at the higher level (around 62°C).

Once the water temperature is reached, the room is heated again.

**SELECT ENERGY SOURCE**

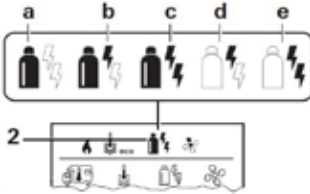

1. Use the control knob/push button to select the energy icon.
2. Click to change to the setting level.
3. Use the control knob/push button to select the required power type.
4. Click the control knob/push button to confirm the value.

SYMBOL	OPERATING MODE	POWER TYPE
a	LP gas LP gas	
b	MIX 1 * Electricity	850W + Gas
c	MIX 2 * Electricity	1700W+ Gas
d	EL 1 * Electricity	850W
e	EL 2 * Electricity	1700W

\* Mixed mode

**SPECIAL ASPECTS IN THE MIXED MODE**

Interruption of the power supply 230v  
 Combi Gas: The heater automatically switches to the gas mode. As soon as the 230v power supply is connected, the heater automatically switches back to the mixed mode.

**MALFUNCTION IN THE COMBUSTION PROCESS (E.G. LACK OF FUEL)**

Combi Gas: The heater automatically switches to the electro mode. If the heater should operate in the mixed mode again, the cause of the malfunction needs to be rectified. Switch the heater off and on again on the control panel.

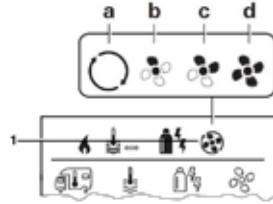

**SELECT FAN LEVEL**

1. Use the control knob/push button to select the fan icon.
2. Click to change to the setting level.
3. Use the control knob/push button to select the required fan level.
4. Click the control knob/push button to confirm the value.

**SET THE TIME SWITCH**

1. Use the control knob/push button to select the timer symbol in the bottom corner.
2. Click to change to the setting level.

If the timer is activated (ON), the timer in the menu is shown as deactivated (OFF).

Enter start time

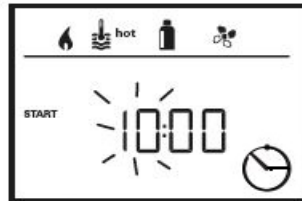

3. Use the control knob/push button to set the hours, then the minutes.

Enter end time point



4. Use the control knob/push button to set the hours, then the minutes.
5. If the start time has passed when entered the operating parameters are only taken into consideration when the next start/end times are reached.

## Set the Room Temperature



6. Click to change to the setting level.
7. Use the control knob/push button to select the required room temperature.
8. Click the control knob/push button to confirm the value.

## Set the Hot Water Level



9. Click to change to the setting level.
10. Use the control knob/push button to select the required hot water level.
11. Click the control knob/push button to confirm the value.

## Select Power Type



12. Click to change to the setting level.
13. Use the control knob/push button to select the power type.
14. Click the control knob/push button to confirm the value.

## Select Fan Level

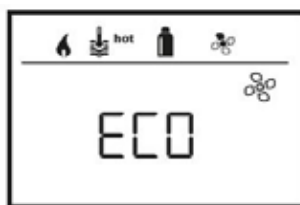

15. Click to change to the setting level.
16. Use the control knob/push button to select the required fan level.
17. Click the control knob/push button to confirm the value.

## ACTIVATE THE TIMER (ON)



18. Click to change to the setting level.
19. Use the control knob/push button to activate the timer (ON).
20. Click the control knob/push button to confirm the value.



The timer remains active, even for several days, until it is deactivated (OFF).

## DEACTIVATE THE TIMER (OFF)



1. Click to change to the setting level.
2. Use the control knob/push button to deactivate the timer (OFF).
3. Click the control knob/push button to confirm the value.

**SET TIME**

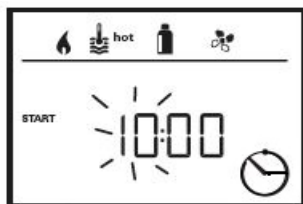

1. Select the clock icon.
2. The hour display flashes.
3. Use the control knob/push button to set the hour (24h mode).
4. After clicking the control knob/push button again, the minute display will flash.
5. Use the control knob/push button to set the minutes.
6. Click the control knob/push button to confirm the value.



**READ OUT OF WARNING**

W = Warning  
 42 = Fault code  
 H = Device (H=Heater)

1. Use the control knob/push button to select the symbol.
2. Click the control knob/push button. The current warning code is shown. The cause of the warning can be identified and rectified via the error list.

**DISPLAY MAINS VOLTAGE 230v**

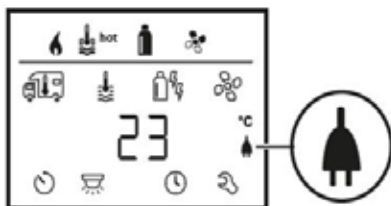

This symbol indicates that 230v mains voltage is available.

**CAUSE RECTIFIED/RETURN TO SETTING LEVEL**

- Click the control knob/push button.

**CAUSE NOT RECTIFIED/RETURN TO SETTING LEVEL**

- Press the back button.



In this case, the warning is not acknowledged on the control panel and the warning symbol remains. The control panel remains in the warning status. Devices connected to the control panel can be operated.

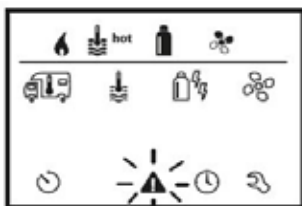

**WARNINGS**

In the event of a warning, a warning symbol appears to indicate that an operating parameter has reached an undefined status. In this case, the affected device continues to run. As soon as the operating parameter returns to set range, this symbol will turn off automatically.

**CANCELLING THE WARNING TRIANGLE**

When the warning triangle is illuminated it indicates a fault. In order to remove the fault triangle you must first resolve the issue. Once the issue has been resolved rotate the knob until the warning triangle flashes. Depress the knob and the flashing will stop.



If the fault has not been resolved the warning triangle will reappear. Continuous cancelling of the warning triangle when the fault has not been resolved will lock the system. Stopping any further function for up to 15 minutes.

# Cool and Convenient Accessories for your Bailey Motorhome



Stay cool with Truma Aventa  
Compact Air conditioning



Check your gas levels  
from your smartphone with  
Truma LevelControl

[www.trumauk.com](http://www.trumauk.com)

heating | cooling | controlling

 **Truma**

More comfort on the move



# THE SEATTLE CONTROL PANEL

---

Home Screen .....	88
Navigation .....	88
Control Panel Buttons .....	89
Mode Description.....	90
Settings.....	91

# THE SEATTLE CONTROL PANEL

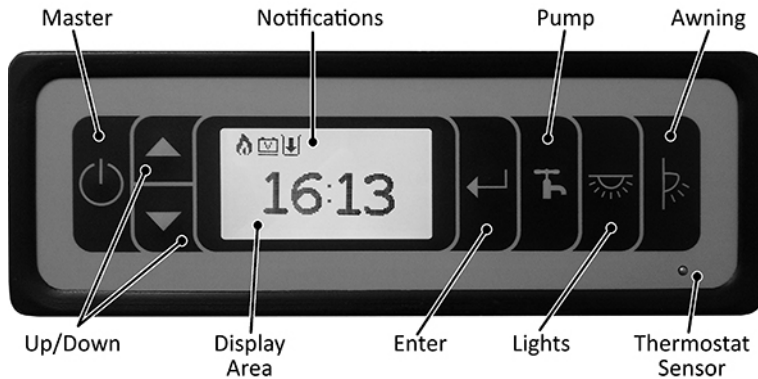

## HOME SCREEN

The home screen is displayed by default. The control panel displays the time as well as any relevant notifications or warnings that are present. If left idle the control panel will return to this screen.

## SETTING THE TIME:

1. From the home screen, press and hold down the ENTER button for 3 seconds until the hours begin to flash.
2. Press the UP or DOWN arrows to change the hour.
3. Press the ENTER button to set the hour; minutes will then flash.
4. Press the UP or DOWN arrows to change minutes.
5. Press ENTER to finish.

The control panel provides the user with a central point to check the following devices:

- Fresh water tank level.
- Waste water tank level.
- Inside temperature.
- Outside temperature.
- User Settings.
- Battery selection; leisure or vehicle.
- Leisure battery voltage.
- Leisure battery amps.

Optional audio and visual warnings are displayed when necessary for:

- Low battery (leisure).
- Low battery (vehicle).
- Low level (fresh water tank).
- High level (waste water tank).
- High power drain (leisure battery).
- Loss of 230V mains supply.
- Function buttons.

## NAVIGATION

1. You can scroll through the settings with the up or down arrow.
2. To edit a setting, scroll to it then press ENTER to select.
3. If there are several options, you may need to use the arrow buttons to change value.
4. Press ENTER to accept new value.
5. To exit, scroll to "Exit to main menu" and press ENTER.

**CONTROL PANEL BUTTONS**

When pressed this will switch the power on to all non-essential accessories.

To shut down the control panel completely, press and hold down the master switch; the set time will be lost and will need to be reset when restarted. The control panel can also be shut down from the User Settings menu.

The alarm, radio and fridge still receive power when the master switch is off.



The following functions can only be controlled when the master switch is turned on.

**LIGHTS SWITCH**



WHEN PRESSED, WILL ENABLE ALL LIGHTS TO BE TURNED ON BY THEIR INDIVIDUAL SWITCHES.

**PUMP SWITCH**



WHEN PRESSED WILL ENABLE OR DISABLE THE WATER PUMP. PRESS AND HOLD THIS BUTTON TO FORCE THE INTERNAL PUMP TO RUN; SEE "NOTIFICATIONS AND WARNINGS" SECTION FOR PUMP RUNNING

NOTIFICATION.

**AWNING SWITCH**



WHEN PRESSED WILL TURN ON THE AWNING LIGHT.

**NAVIGATION BUTTONS**









Use the UP or DOWN arrows to navigate through the menus.

Press ENTER to change the setting or additional settings (if available).

**NOTIFICATION AND WARNING ICONS**









There are a number of icons that can appear at the top of the time screen.

Refer to the table below for a brief description of each icon.

Icon	Description
	Internal pump is running.
	Leisure battery is below 12.2V.
	Over 12A of current is being drawn from the leisure battery.
	The fresh water tank level is below 10%.
	The waste water tank is over 75% full.
	The living space is being powered by the vehicle's battery rather than the leisure battery.
	The 230V mains is connected.
	A connected gas appliance is using the gas supply.

When a new warning is triggered it may be accompanied by a pop up alarm screen if the appropriate User Setting is enabled. When this happens the control panel will flash and beep until the warning is acknowledged by pressing the ENTER button.

## MODE DESCRIPTION

Icon	Mode	Description
	Water Level	The level in the fresh water tank is displayed as a % on the screen.
	Waste Level	The level in the waste water tank is displayed as a % on the screen.
	Fill Internal Tank	With the external pump connected to the inlet and to an external water source, press to fill the internal tank. Note: When the internal tank is full, the pump will stop automatically.
	External Temperature	The outside temperature, as detected by a sensor underneath the motorhome, is displayed on this screen. You can change between degrees Celsius and degrees Fahrenheit by pressing ENTER and selecting UP for °C or DOWN for °F.
	Internal Temperature	The inside temperature, as detected by a sensor inside the control panel, is displayed on this screen. You can change between °C and degrees °F by pressing ENTER and selecting the UP button for °C or DOWN for °F.
	Select Battery	With 230V mains disconnected, the user can choose to draw power from the leisure battery OR the vehicle battery. Press ENTER to swap between batteries. If the "Auto-Battery" feature is enabled (see "User Settings" section) the system will automatically switch to "Vehicle Battery" if the "Leisure Battery Voltage" is low (less than 11V). When 230V mains is connected "Leisure Battery" is automatically selected and cannot be changed.
	Leisure Battery Amps	This screen shows the current being drawn from your leisure battery, in amps, which is displayed on this screen. A higher current will drain your battery faster.
	Leisure & Vehicle Battery Voltage	This screen shows the voltage of the selected battery as set on the "Select Battery" screen. If a 230V mains supply is connected then the charging voltage of the leisure battery will be displayed. An estimate of your batteries' remaining charge can be seen by pressing ENTER then the DOWN button. 12V or less reads 0%, and 12.7V or more reads 100%. You can return to display the voltage by pressing ENTER then the UP button. To increase accuracy of the battery voltage reading, switch the "Master Switch" off.
	User Settings	Press the UP or DOWN button to access the User Settings screen.

## SETTINGS

### CONTRAST:

Adjusts the contrast of the LCD display if you are finding it difficult to read.

### SOUND:

Enables or disables the sound when a button is pressed.

### CHG V BATT:

When enabled the vehicle battery will be charged while 230V mains is connected. The leisure battery will also be charged at the same time.

### STANDBY:

Sets how long the control panel waits for a button press before going into standby.

### WATER LOW:

Enables or disables the warning alarm when the water tank is low;

- > Press ENTER to acknowledge an alarm that has triggered. The warning will only re-arm when the water level increases by 25%.

### WASTE HIGH:

Enables or disables the warning alarm when the waste tank is high;

- > Press ENTER to acknowledge an alarm that has triggered; the warning will only re-arm when the waste level is reduced to 50%.

### 230V Lost:

Enables or disables the warning alarm when the 230V mains connection is lost;

- > Press ENTER to acknowledge an alarm that has triggered; the warning will only re-arm when the 230V connection is restored.

### AMPS HIGH:

Enables or disables the warning alarm when the current drawn from the leisure battery exceeds 12A;

- > Press ENTER to acknowledge an alarm that has triggered; the warning will only re-arm

when the current is reduced below 5A.

### VEH BATT LOW:

Enables or disables the warning alarm when the vehicle battery voltage is less than 11V;

- > Press ENTER to acknowledge an alarm that has triggered; the warning will only re-arm when the vehicle battery is charged over 13V.

### LEIS BATT LOW:

Enables or disables the warning alarm when the leisure battery voltage is less than 11V;

- > Press ENTER to acknowledge an alarm that has triggered; the warning will only re-arm when the leisure battery is charged over 13V.

### AUTO BATTERY:

When enabled the power source will switch to vehicle battery automatically if the leisure battery is low. When a charging voltage is detected, the power source will switch back to leisure battery.

### SHUT DOWN NOW:

Pressing ENTER will shut the control panel down into its low power mode. The master switch will be turned off and the clock will lose its time.

- > Press any button to turn the panel back on.

### FIRMWARE:

Displays the current firmware version installed on the control panel.

### EXIT TO MAIN MENU:

Saves any changes to the settings and navigates back to the main menu.

# THE DIGITAL ANTENNA SYSTEM

---

The Status 550 Digital Antenna System.....	93
Operating The System.....	93
Fault Finding.....	95

# THE DIGITAL ANTENNA SYSTEM

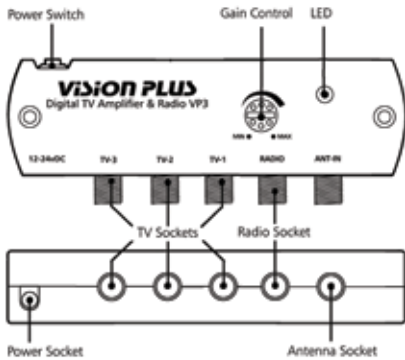

Frequency Range UHF 470-860 Mhz  
 Frequency Range VHF 40-230 Mhz  
 Frequency Range FM 88-108 Mhz  
 Amplifier Gain Max 18db  
 Gain Adjustment 15db  
 Flatness +1.5db  
 Noise Figure 2db  
 Output Impedance 75ohms  
 Signal Handling 80dbuv  
 Power Supply 10.8-28v DC  
 Power Consumption 55ma

## TRAVELLING



Do not travel in the following circumstances.

- With the antenna raised.
- With the antenna set for vertical signals.

When travelling adjust the antenna so that it points to the rear of the vehicle to reduce the possibility of damage when travelling.

## OPERATING

1. Firstly determine the approximate location of the nearest transmitter and whether the signals are horizontally or vertically polarised. For assistance ask your site operator or check other antennas in the vicinity.
2. Loosen the mast locking collar and raise the antenna. Rotate the mast to direct the antenna towards the TV transmitter.

3. The H/V indicator on the bottom of the mast indicates the back of the antenna.
4. Should you need to receive vertically polarised signals, rotate the winder anti-clockwise to tilt the antenna through 90°.
5. DO NOT use undue force on the winder.
6. Switch ON the amplifier and the LED will illuminate.
7. Check the gain control is set to maximum. For maximum rotate clockwise.
8. Tune your television into the strongest signal. You may need to adjust the direction of the mast to achieve the best picture quality.
9. Secure by tightening the mast locking collar.

## DAB AND FM RADIO OPERATION

Status is designed to receive DAB and FM when connected to a radio with DAB/FM facility. Dependent on location, DAB and FM reception may be improved by setting the antenna to vertical.

## COAXIAL CONNECTIONS

It is critical that all connections in the system are fitted correctly.

## GAIN CONTROL

In normal use the button should be rotated clockwise for maximum. In strong signal areas the amplification may need to be reduced. To reduce amplification rotate the button anti-clockwise until picture quality improves. The button rotates through 270° from MAX to MIN.

## LED LIGHT

Should the LED on the amplifier not light, firstly check there is power to the unit. Secondly check the polarity is correct. Otherwise contact Grade UK Ltd for further assistance.

## SHORT HOOK UP: TEST 1

This test isolates the wiring from the amplifier through to your TV/radio points. Unplug the coaxial plugs from the "TV" sockets of the amplifier and use your TV fly lead with converter 1 supplied. Connect your TV to the amplifier.

Please ensure the antenna dome is plugged directly into the "ANT-IN" socket of the amplifier and switch on. Tune in your TV for the strongest signal. If the picture quality improves the fault lies with the wiring of the system between the amplifier and TV outlet socket.

### **SHORT HOOK UP: TEST 2**

This test isolates the amplifier by connecting your TV directly to the antenna.

Unplug the antenna from the amplifier and connect converter 2 supplied to the plug on the cable end. Using your fly lead, connect the antenna directly to your TV. Tune in your TV for the strongest signal.

If the picture quality improves, the fault lies with the amplifier.

### **ANTENNA DOME COAXIAL CABLE**

Check the routing of the coaxial cable from the antenna dome to the amplifier. Check to ensure there are no kinks or trapped cable or if there are loops of surplus cable which could affect performance.

Should you still be experiencing difficulties and require assistance, please do not hesitate to contact Vision Plus for further assistance on +44 (0) 115 986 7151

or

Visit [www.visionplus.co.uk](http://www.visionplus.co.uk)



It is the responsibility of the motorhome owner to make sure that the directional aerial is fully retracted before the motorhome is moved. Any damage as a result of neglect, i.e. not retracting the aerial, crash damage, vandalism or incorrect operation will NOT be covered by the manufacturer's warranty.



Signal	Symptom	Action
Very poor	No picture or sound, TV freezing, severe pixelation, break-up and picture drop out.	Check the amplifier gain is set to maximum (rotate clockwise). Check antenna alignment which must be directed at the transmitter. Ensure the antenna polarity is correct, whether horizontal or vertical. Bypass the amplifier by following 'Short Hook-up: Test 1'.
Poor	Moderate pixelation and sound distortion	
Medium	Minor pixelation, will not receive all channels.	
Good	Stable picture, good sound quality, will receive all channels.	N/A
Strong	Possible pixelation, picture break-up and drop out.	Reduce the amplifier gain (rotate anti-clockwise). Rotate antenna AWAY from the transmitter.
Very strong	No picture or sound, TV freezing, severe pixelation, break-up and picture drop out.	Rotate antenna AWAY from the transmitter. Switch OFF the amplifier and turn the gain control to maximum (rotate clockwise).
After performing any of the actions above you must re-tune your TV		

## COOKING EQUIPMENT

---

Operation.....	97
Using the Hotplate Gas Burners.....	97
Using the Electric Hotplate.....	98
Using the Grill.....	98
Using the Oven.....	99
Oven Temperature Control.....	99
Maintenance and Servicing.....	100

## COOKING EQUIPMENT



Never use oversized pans as this will lead to damage within the caravan.

- Each burner will support pans from  $\varnothing 10$  to  $\varnothing 18$ cm; care should be taken not to overload the appliance as performance may be reduced.
- When using small pans the flames should not spread beyond the base of the pan as this will reduce the efficiency of the burner.
- Avoid old or misshapen pans as these may cause instability.
- The lid must be opened fully prior to using the hotplate burners.
- For guaranteed damage free cooking it is recommended you use  $\varnothing 180$ mm pans.

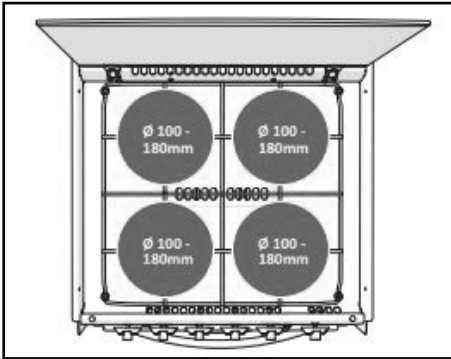

Never use the cooker as a space heater

Before using the appliance please ensure that you are aware of the following:

- Appliance and accessible parts become hot during use.
  - Avoid touching heating elements.
  - Children less than 8 years of age shall be kept away unless continuously supervised.
- This appliance can be used by children aged 8 years and above, persons with reduced physical, sensory or mental capabilities and/or lack of experience and knowledge only if they have been given supervision or instruction concerning use of the appliance in a safe way and understand the hazards involved.
- Children shall not play with the appliance.
  - Cleaning and user maintenance shall not be made by children without supervision.

- Unattended cooking on a hob with fat or oil can be dangerous and may result in fire.
- Never extinguish a fire with water; switch off the appliance and cover flame with lid or fire blanket.
- Danger of fire: Do not store items on the cooking surface.
- Do not use harsh abrasive cleaners or sharp metal scrapers to clean the oven door glass since they can scratch the surface, which may result in shattering of the glass.
- Never use a steam cleaner to clean the appliance.

### OPERATION

The burners on this appliance have fixed aeration and no adjustment is required. The burners should flame as follows:  
 Propane: The flames should burn quietly with a blue/green colour with no sign of yellow tips.  
 Butane: Normally, on initial lighting, a small amount of yellow tipping will occur. This then increases slightly as the burner heats up.

### USING THE HOTPLATE GAS BURNERS



Ensure that the glass lid is open before turning on the burners.

- Glass lids may shatter when heated.
- Turn off all burners before shutting the lid.
- The glass lid has a tendency to snap shut towards the lowered position. Ensure fingers are away from the entrapment area when closing the lid.
- Remove all spillages from the glass lid before opening.
- Children should be supervised to ensure that they do not play with the appliance.
- Ensure gas cylinder/supply is connected and turned on. In the event of a gas smell turn off at gas cylinder/mains and contact supplier.
- Flame supervision: each burner is controlled individually and is monitored by a thermocouple probe. In the event of the burner flames being accidentally extinguished, turn off the burner control and do not attempt to re-ignite the burner for at least one minute.

### LIGHTING PROCEDURE

1. Push in the control knob and turn to full rate-large flame.
  2. Hold in knob and light the hob by depressing the ignition button, which is located on the fascia. It is necessary to hold the knob depressed after the burner has ignited for approximately 10-15 seconds, to allow the thermocouple probe to reach temperature, before releasing the knob.
- Should the flame go out when the knob is released, the procedure should be repeated holding the knob depressed for slightly longer.
  - If the burner has not lit within 15 seconds the control knob should be released and the burner left for at least 1 minute before a further attempt to ignite the burner.
  - For simmering, turn the knob further anti-clockwise to the low rate position.
  - To turn off: turn the control knob until the line on the control knob is aligned with the zero on the control panel. Always make sure the control knob is in the off position when you have finished using the hotplate burners.

### USING THE ELECTRIC HOTPLATE (DUAL FUEL MODELS)

1. Ensure power is switched on.
2. The hotplate control is numbered from 1 to 6. To turn it on, rotate the knob either clockwise or anti-clockwise to the required position. Position 1 is the coolest setting.
3. To turn off, rotate the knob until the line or pointer on the knob lines up with the zero on the control panel.

The hotplate is a sealed construction and transfers heat through conduction. For maximum efficiency a correctly sized pan with a flat heavy gauge base should be used. Pan size should be the same or slightly larger (up to 1" / 2.5cm oversize).

Before using your hotplate for the first time, we recommend that you prime it.

### TO PRIME THE HOTPLATE

1. Switch on the hotplate for a short period, without a pan, to harden and burn off the coating.

2. Use a medium to high setting for 3-5 minutes. A non-toxic smoke may occur during this process.
3. Allow it to cool.

### USING THE GRILL

Ensure gas cylinder/supply is connected and turned on. In the event of a gas smell turn off at gas cylinder/mains and contact supplier.

### TO LIGHT

1. Open door.
2. Push in the control knob and turn to full rate/large flame.
3. Push the control knob in and hold whilst pressing the ignition switch.
4. The burner should ignite and the control knob should be held in for 10-15 seconds before release. If the burner goes out, repeat procedure holding control knob for slightly longer.

The heat deflector below the fascia should be pulled out prior to lighting the grill. Never adjust the heat deflector position without using hand protection - i.e. oven gloves.

Accessible parts may be hot when the grill is in use. Young children should be kept away. Ignition must always be carried out with the door open.

On first use of the grill, it should be heated for about 20 minutes to eliminate any residual factory lubricants that might impart unpleasant smells to the food being cooked. A non-toxic smoke may occur when using for the first time so open any windows and turn on mechanical ventilators to help remove the smoke.

Although the grill does heat up quickly, a few minutes preheat is recommended.

Flame Failure Device (FFD): the grill burner is fitted with a flame-sensing probe, which will automatically cut off the gas supply in the event of the flame going out. In the event of the burner flames being accidentally extinguished, turn off the burner control and do not attempt to re-ignite the burner for at least 1 minute.

It is normal for the flames on this burner to develop yellow tips as it heats up. A reversible grill pan trivet enables the correct grilling height to be achieved.

**TO TURN OFF**

1. Turn the control knob until the line on the control knob is aligned with the dot on the control panel. Always make sure the control knob is in the off position when you have finished grilling.



The grill area can get hot when the oven is in use, even if the grill is switched off. Care should be taken when removing pans from the grill, i.e. by use of oven gloves, and by making use of the removable grill pan handle.



The grill pan supplied is multi-functional, for use in grill or oven. The handle design allows removal or insertion while the pan is in use. Always remove the handle when the pan is in use. The grill **MUST** only be used with the door open.

**USING THE OVEN**

Ensure gas cylinder/supply is connected and turned on. In the event of a gas smell turn off at gas cylinder/mains and contact supplier.

**TO LIGHT**

1. Open door.
2. Push in the control knob and turn to full rate (240°C).
3. Push the control knob in and hold whilst pressing the ignition switch.
4. The burner should ignite and the control knob should be held in for 10-15 seconds before release. If the burner goes out, repeat procedure holding control knob for slightly longer.
5. Place the oven shelf in the required position and close the door.
6. Set the control knob to required temperature.

Although the oven heats up quickly, it is recommended that a 10 minute preheat be allowed. The oven should be up to full temperature in about 15-20mins.

**TO TURN OFF**

1. Turn the control knob until the line on the control knob is aligned with the zero on the control panel. Some ovens have a cooling fan which may run on when oven turned off for upto 30mins to ensure oven is cooled down.

The shelf has been designed to allow good circulation at the rear of the oven and is also fitted with a raised bar to prevent trays or dishes making contact with the back of the oven. To remove a shelf, pull forward until it stops, raise at the front and remove. Installation of a shelf is the reverse of this procedure.



Before first use, heat the oven for about 30 minutes at 200°C, to eliminate any residual factory lubricants that might impart unpleasant smells to the meals being cooked. A non-toxic smoke may occur when using for the first time so open any to help remove the smoke. Always ensure food is properly cooked prior to serving.

**OVEN TEMPERATURE CONTROL**

The temperature in the oven is controlled by a thermostatic gas tap and is variable over the range 130°C to 240°C. Approximate temperatures for the settings on the control knob are shown in the table overleaf. The temperatures indicated refer to the centre of the oven and at any particular setting the oven will be hotter at the top and cooler towards the base.

The variation between top and centre, and centre to bottom is approximately equivalent to one gas mark. Good use can be made of the temperature variation in that several dishes requiring different temperatures may be cooked at the same time. In this way maximum benefit can be obtained from the gas used to heat the oven. Care should be taken not to overload the oven, with adequate spacing being used to allow free circulation for heat.

**COOKING GUIDELINES**

Although the oven heats up quickly, it is recommended a 10 minute preheat be allowed. The oven should reach full temperature in 15-20 minutes.

When roasting with aluminium foil, care must be taken that the foil does not impair circulation or block the oven flue outlet.

GAS MARK	TEMPERATURE (CENTRE OF OVEN)			DISH
	265 - 275°F	130-135°C	Very Cool	
1/4 - 1/2	265 - 275°F	130-135°C	Very Cool	Meringues
1	285	140	Cool	Stewed Fruit
2	300	150	Cool	Rich fruit cake, rice pudding
3	330	165	Warm	Baked custard, shortbread fingers
4	355	180	Moderate	Victoria sandwich
5	385	195	Fairly Hot	Whisked sponges, ginger nuts
6	410	210	Hot	Short crust pastry
7	430	220	Hot	Bread, scones, flaky pastry
8	445	230	Very Hot	Puff pastry
9	465	240	Very Hot	Quick browning

### DOS AND DON'TS

DO read the user instructions carefully before using the appliance for the first time.

DO allow the oven to heat before using for the first time, in order to expel any smells before the introduction of food.

DO clean the appliance regularly.

DO remove spills as soon as they occur.

DO always use oven gloves when removing food shelves and trays from the oven.

DO check that controls are in the off position when finished.

DO read the user instructions carefully before using the appliance for the first time.

DO NOT allow children near the cooker when in use. Turn pan handles away from the front so that they cannot be caught accidentally.

DO NOT allow fats or oils to build up in the oven trays or base.

DO NOT use abrasive cleaners or powders that will scratch the surface of the appliance.

DO NOT under any circumstances use the oven as a space heater.

DO NOT put heavy objects onto open grill and oven doors.

DO NOT allow the door to fall down: lower it by hand.



Ensure that the ceramic ball mixer tap arm is clear from the oven lid before raising it. Failure to do so could accidentally switch on the tap when lifting the glass lid.



On Autograph models the metal locker catch above the cooker may become hot when using the hot plate.

### MAINTENANCE AND SERVICING

This appliance needs little maintenance other than cleaning. All parts should be cleaned using warm soapy water. Do not use abrasive cleaners, steel wool or cleansing powders. When cleaning the burner ring it is essential to ensure that the holes do not become blocked. The control knobs are push fit and can be removed for cleaning. They are interchangeable without affecting operation.



All servicing must be carried out by an approved competent person. After every service the appliance must be checked for gas soundness.



### LEAKS

If a smell of gas becomes apparent, the supply should be turned off at the cylinder IMMEDIATELY.

- Extinguish naked lights including cigarettes and pipes.
- Do not operate electrical switches.
- Open all doors and windows to disperse any gas escape.
- Never check for leaks with a naked flame; leak investigation should be carried out using a leak detector spray.
- Check the gas is not escaping from an unlighted appliance.

### SERVICE

The cooker must be serviced at least once every 12 months. All servicing must be carried out by an approved competent person. Before any service work is started, the appliance should have been left to cool and be disconnected at the mains socket. After each service the appliance must be checked for gas soundness.

For service, please contact your authorised local service agent giving details of the model and serial number on the data badge plus date of purchase.



Some models have both a worktop lid and glass lid covering the hob burners. Please be aware that both the glass and worktop lids may become hot during the use of the grill and/or oven. Therefore Bailey and Thetford strongly advise you lift both lids up when using the grill and/or oven to avoid any potential product/injury issues.

# THE MICROWAVE OVEN

---

Russell Hobbs Microwave Oven.....103  
Product Overview .....105  
Cooking .....106  
Maintenance and Cleaning .....108



## RUSSELL HOBBS MICROWAVE



This appliance can be used by children aged from 8 years and above and persons with reduced physical, sensory or mental capabilities or lack of experience and knowledge if they have been given supervision or instruction concerning use of the appliance in a safe way and understand the hazards involved. Children shall not play with the appliance.

Do not use harsh abrasive cleaners or sharp metal scrapers to clean the oven door glass since they can scratch the surface, which may result in shattering of the glass.

Cleaning and user maintenance shall not be made by children unless they are aged from 8 years and above and supervised.



Do not use the microwave when it is empty. This could damage the oven.



The appliance and its accessible parts become hot during use. Care should be taken to avoid touching heating elements.



If the door or door seals are damaged, the oven must not be operated until it has been repaired by a competent person.



It is hazardous for anyone other than a competent person to carry out any service or repair operation that involves the removal of a cover which gives protection against exposure to microwave energy.



Liquids and other foods must not be heated in sealed containers since they are liable to explode.



Only allow children to use the microwave without supervision when adequate instructions have been given so that the child is able to use the oven in a safe way and understands the hazards of improper use.

- If the supply cord is damaged, it must be replaced by the manufacturer, its service agent or similarly qualified persons in order to avoid a hazard. When heating food in plastic or paper containers, keep an eye on the oven due to the possibility of ignition.
- Only use utensils that are suitable for use in microwave ovens.
- You should clean the outside of the oven with a damp cloth. Do not allow water to seep into the ventilation openings.
- Do not allow the control panel to become wet. Clean with a soft, damp cloth. Do not use detergents, abrasives or spray-on cleaners on the control panel.
- If steam builds up inside or around the outside of the oven door, wipe with a soft cloth. This may happen when the microwave oven is used in humid conditions.
- Regularly remove the glass turntable to clean it, and wash it in warm soapy water. Regularly clean the turntable support and oven floor. Simply wipe the bottom surface of the oven with mild detergent and water, then dry. You can wash the turntable support in mild soapy water.
- If smoke is emitted, switch off or unplug the appliance and keep the door closed in order to stifle any flames.
- Microwave heating of beverages can result in delayed eruptive boiling, therefore care must be taken when handling the container.
- Eggs in their shell and whole hard-boiled eggs should not be heated in microwave ovens since they may explode, even after microwave heating has ended.
- The oven should be cleaned regularly and any food deposits removed. Failure to maintain the oven in a clean condition could lead to deterioration of the surface that could adversely affect the life of the appliance and possibly result in a hazardous situation.

- Before you clean the oven, turn it off and unplug it. Keep the inside of the oven clean. When food or liquids stick to the oven walls, wipe with a damp cloth. We recommend that you do not use harsh detergent or abrasives.
- The contents of feeding bottles and baby food jars shall be stirred or shaken and the temperature checked before consumption in order to avoid burns.
- Food containing a mixture of fat and water (for example, stock) should stand for 30 to 60 seconds in the oven after it has been turned off. This is to allow the mixture to settle and to prevent it from bubbling when a spoon is placed in it, or a stock cube is added.
- When heating or cooking food or liquid, remember that there are certain foods (such as, jam, Christmas puddings and mincemeat) which heat up very quickly.
- When heating or cooking foods that contain a lot of fat or sugar, do not use plastic containers.
- Always have the glass tray and turntable support in place when using the oven.
- Never remove parts from the oven such as the feet, screws and so on.
- Do not cook food directly on the glass tray. Put food on a suitable plate or in a bowl before putting it in the oven. To reduce the risk of fire in the oven cavity: Do not overcook food.
- Do not leave the microwave oven unattended while you are using it and if using paper or plastic containers check regularly to ensure they do not ignite.
- Remove wire twist-ties from bags before putting the bag in the oven.
- If materials inside the oven smoke or catch fire, keep the oven door closed to stifle the flames, turn the oven off at the wall switch, or shut the power off at the fuse or circuit-breaker panel.
- The microwave is intended for heating food and beverages. Drying of food or clothing and heating of warming pads, wheat bags, slippers, sponges, damp cloth and similar may lead to risk of injury, ignition or fire.
- Heat from the contents of a container may be transmitted to the container itself, so please be careful when removing it from the oven. Please remember that the food or liquid inside may be releasing some steam or may be spitting. Never cover any container fully, always leave a gap for steam to escape.
- Cooking utensils may become hot because of heat transferred from the heated food. This is especially true if plastic wrap has been covering the top and handles of the utensil. You may need oven gloves to handle the utensil.
- Ensure you do not use any corrosive chemicals or vapours in the appliance. It is not designed for industrial or laboratory use.
- Never put any objects into the openings on the outer case.
- On the right hand side wall of the cavity is the wave guide cover, microwaves are passed through this to enable your food to cook. It is important that this wave guide cover is kept clean at all times. To do this wipe with mild detergent and water, then dry.
- When removing the turntable support of the oven, make sure you put it back properly.
- If the inside of the oven smells, put a cup of water with the juice and skin of one lemon in a deep microwave bowl. Microwave it for three minutes, wipe thoroughly and then dry with a soft cloth.
- Do not try to deep-fry foods in this oven.
- Do not use metal pans or dishes with metal handles.
- Do not use anything with a metal trim.
- Do not use paper covered wire twist-ties on plastic bags.
- Do not use melamine dishes as they contain a material which will absorb microwave energy. This may cause the dishes to crack or burn, and will slow down the cooking speed.
- Use only cookware that is approved to be used in a microwave oven.
- Do not cook using containers with restricted openings, such as bottles, as they may explode.
- Do not heat baby bottles with the teat left on. Remove it if replacing the bottle back into the oven.
- Do not use the microwave oven for heating utensils.
- Do not use the oven for any reason other than preparing food, such as for drying clothes, paper or any other non-food items, or for sterilising purposes.

- Do not store anything in the oven, such as paper, or cook books .
- Do not cook any food surrounded by a membrane, such as egg yolks, potatoes, chicken livers, sausages, ready meals and so on without piercing them several times with a fork.
- Never put any objects into the openings on the outer case.
- You should use microwave utensils only in line with these instructions.
- Only use the accessories supplied by the manufacturer.

Microwaves are high-frequency electromagnetic waves similar to radio waves. While radio waves may vary in length from one metre to many kilometres, microwaves are very short (less than 12.5 centimetres). Microwaves do not make any heat themselves but only cause water molecules in food to vibrate. This vibration produces heat that cooks the food. This is why your food will come out of the microwave piping hot, when your utensils inside the oven stay much cooler. The microwaves do not stay in the air or in the food when you open the microwave oven door.

The microwave oven will work using an ordinary household electrical socket. Inside the microwave oven is the magnetron, which turns the electrical energy into microwaves.

Microwaves cannot go through metal, so the inside of the oven is lined with metal. The door is lined with a fine metal mesh which stops microwaves getting through. This means that when the microwave oven door is shut, there is no possibility that microwaves can be released. This is why the microwave oven has been made so that it will not work when the door is open.

## PRODUCT OVERVIEW

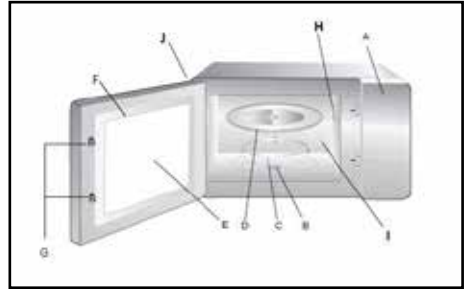

- A. Control panel (including door release button)
- B. Turntable shaft
- C. Turntable ring assembly
- D. Glass turntable
- E. Observation window
- F. Door assembly
- G. Safety interlock latches
- H. Wave guide cover
- I. Oven cavity
- J. Ventilation slots

## CONTROL PANEL

### MENU ACTION SCREEN

Cooking time, power, auto, and the clock time are displayed.

### POWER

Press to select the power level for microwave cooking. Press the Left Hand Side of the button.

### WEIGHT/TIME DEFROST

Press this button to input weight for defrosting. Press the Right Hand Side of the button.

**CLOCK/PRE SET** Press this button to set the clock and use the preset function.

**STOP/CLEAR** Press to stop the cooking process, press the RHS.

**TIMER/WEIGHT/AUTO MENU** Rotate to select the cooking time and the auto menus.

**START/+30SEC/CONFIRM** Press this button to start the cooking process and confirm when programming.

**DOOR OPEN** Pull the handle to open the door.

**CLOCK SETTING**

When the microwave oven is first turned on, the oven will display "0:00", the buzzer will ring once.

- 1) Press "-SET" to choose hours or minutes for alteration. The hour figures will flash. When altering the hours the "0" on the Left Hand Side will flash.
- 2) Turn the dial to adjust the hour figures, 0 - 23 (this is a 24-hour clock).
- 3) Press "CLOCK/PRE-SET" button again and the minute figures will flash.
- 4) Turn the dial to adjust the minute 0 - 59 (60-minutes).
- 5) Press "CLOCK/PRE-SET" to finish the clock setting procedure. The ":" will then flash. Note: the input time should be within figures, the input time should be within "TIMER/WEIGHT/AUTO MENU" "TIMER/WEIGHT/AUTO MENU" "CLOCK/PRE



- 1) If the clock is not set, some features of the microwave oven will not operate.
- 2) During the process of clock setting, if you press "STOP/CLEAR", the oven will go back to the previous status.

1) Press the "POWER" button once, and "P100" and flash.

2) Turn the "TIMER/WEIGHT/AUTO MENU" to select the microwave "P80", "P50", "P30", "P10" will display in order.

or

Press the button to scroll through the power levels.

3) Press "START/+30SEC/CONFIRM" to confirm.

4) Turn the "TIMER/WEIGHT/AUTO MENU" dial to adjust the cooking time (The time setting should be between 0:05- 95:00.)

5) Press "START/+30SEC/CONFIRM" to start the cooking process.

Press power button	Cooking power	Equivalent power rating
P100	100%	800 W
P80	80%	640 W
P50	50%	400 W
P30	30%	240 W
P10	10%	80 W

To stop the cooking process at anytime press the "STOP/CLEAR" button

**SPEEDY COOKING**

Press the "START/+30SEC/CONFIRM" button to microwave cook at 100% power level for 30 seconds.

The microwave will start cooking immediately. Each press on the same key will increase the cooking time by 30 seconds. The maximum cooking time is 95 minutes.



Note: this function does not work for defrost and auto menu.

Alternately turn the "TIMER/WEIGHT/AUTO MENU" dial to adjust the desired cooking "START/+30SEC/CONFIRM".

The oven will start cooking for the selected length of time at 100% power.

**DEFROSTING BY WEIGHT**

- 1) Press "WEIGHT/TIME DEFROST" button once, the oven will display "dEF1".
- 2) Turn the "TIMER/WEIGHT/AUTO MENU" dial to select the weight of the weight should be set between 100-2000g.
- 3) Press "START/+30SEC/CONFIRM" button to start defrosting.

**DEFROSTING BY TIME**

- 1) Press "WEIGHT/TIME DEFROST" button twice, the oven will display "dEF2".
- 2) Turn the dial "TIMER/WEIGHT/AUTO MENU" to select the defrosting time, the maximum time is 95 minutes.
- 3) Press "START/+30SEC/CONFIRM" button to start defrosting. The defrosting power is 30%, and cannot be changed.

**MULTI-STAGE COOKING**

To set a maximum of two different stages. For instance, to defrost an item and the follow it with the cooking cycle.



The auto menu cannot be set as one of the multi-stage cooking functions.

Example: if you want to defrost 500g of food, then cook it at 80% microwave power for 7 minutes. The steps are as follows:

- 1) Press button once, the screen will display "dEF1"
- 2) Turn the dial to adjust the defrost ;
- 3) Press the button once;
- 4) Turn the dial to choose 80% microwave
- 5) Press "START/+30SEC/CONFIRM" to confirm;

6) Turn the "TIMER/WEIGHT/AUTO MENU" dial to adjust the cooking time to 7 minutes; 7) Press the "START/+30SEC/CONFIRM" button to start the cooking process.

### PRE-SET TIME TO START FUNCTIONS

Set the clock first. (Consult the instructions for setting the clock) Input the cooking program. It's possible to input a maximum of 2 cooking stages. Do not use the defrost function in the pre-set function. The auto menu can be set for a single stage only.

Example: if you want to cook with 80% microwave power for 7 minutes, to start at a given time.

- 1) Press the "POWER" button once;
- 2) Turn the "TIMER/WEIGHT/AUTO MENU" dial to choose 80% microwave power till "P80" is displayed;
- 3) Press "START/+30SEC/CONFIRM" button to confirm;
- 4) Turn the "TIMER/WEIGHT/AUTO MENU" dial to adjust the cooking time to 7 minutes;
- 5) After the above steps, DO NOT press "START/+30SEC/CONFIRM" button, but do as follows :
- 6) Press the "CLOCK/PRE-SET" button, the current time displays and the hour figures flash.
- 7) Turn "TIMER/WEIGHT/AUTO MENU" dial to adjust the hours, the input should be within 0-23. Press "CLOCK/PRE-SET" button and the minute figures will flash. Turn the "TIMER/WEIGHT/AUTO MENU" dial to adjust the minutes, the input time should be within 0-59. This sets the start time.
- 8) Press "START/+30SEC/CONFIRM" to finish setting.

The ":" will illuminate, the buzzer will ring twice when the time to start arrives, and then cooking will start automatically.



The clock must be set first. Otherwise, the pre-set function will not work.

### AUTO MENU

The microwave can automatically calculate the cooking time based on the type of food and weight.

- 1) Turn the "TIMER/WEIGHT/AUTO MENU" dial clockwise, "A-1" will display on the screen. Continue to rotate the dial to access the other auto selections, up to A-8.
- 2) Press the "START/+30SEC/CONFIRM" button to select the chosen auto, A-1 - A-8.
- 3) Turn the "TIMER/WEIGHT/AUTO MENU" dial to choose the food weight, these are pre-set and listed below.
- 4) Press "START/+30SEC/CONFIRM" button to start cooking. Please see the table below for the various settings.

Display	Auto Menu	Weight (g) on the Display	Power
A-1	Reheat	200	100%
		400	
		600	
A-2	Vegetable Add water.	200	100%
		300	
		400	
A-3	Fish	250	80%
		350	
		450	
A-4	Meat	250	100%
		350	
		450	
A-5	Pasta	50(add 450ml water)	80%
		100(add 800ml water)	
A-6	Potato	200	100%
		400	
		600	
A-7	Pizza	200	100%
		400	
		600	
A-8	Soup	200	80%
		400	
		600	

In all cases allow the food to stand in the microwave for 1-2 minutes after the cooking cycle is complete.

### CHECKING FUNCTIONS

- 1) During the cooking cycle, press the "POWER" button and the current power will be displayed for 2-3 seconds.
- 2) In pre-set state, press the "CLOCK/PRE-SET" button to check the time when the cooking will start. The pre-set time will flash for 2-3 seconds, then the oven will turn back to the clock display.
- 3) During the cooking cycle, press the "CLOCK/PRE-SET" button to check the current time. It will be displayed for 2-3 seconds.

### CHILD LOCK

Lock on: In standby, when nothing is operating, Press "STOP/CLEAR" button for 3 seconds, there will be a long "beep" as the lock activates. A rectangle will illuminate in the display.

Lock off: In locked state, press “STOP/CLEAR” button for 3 seconds, there will be a long “beep”.

The current time will continue to display.

When the child lock is on, no functions can be activated.

#### GENERAL INFORMATION

- The buzzer will sound once when turning the knob at the beginning;
- The “START/+30SEC/CONFIRM” button must be pressed again to continue cooking if the door is opened during a cooking cycle.
- Once the cooking programme has been set, if the “START/+30SEC/CONFIRM” button is not pressed in 1 minute. The current time will display and the setting will be cancelled.
- The buttons will beep if they are pressed correctly, if not pressed correctly they will not beep.
- The buzzer will sound five times to remind you when cooking is finished.

#### IMPORTANT UTENSIL INFORMATION

- Do not use metal pans or dishes with metal handles.
- Do not use anything with a metal trim.
- Do not use paper covered wire twist-ties on plastic bags.
- Do not use melamine dishes as they contain a material which will absorb microwave energy. This may cause the dishes to crack or burn, and will slow down the cooking speed.
- Use only cookware that is approved to be used in a microwave oven.
- Do not cook using a container with a restricted opening, such as bottles, as they may explode.
- Do not heat baby bottles with the teat left on. Remove it if replacing the bottle back into the oven.
- Only use thermometers that are approved for microwave ovens.
- Do not use the microwave oven for heating utensils.

#### CLEANING AND CARE

- Before you clean the oven, turn it off and unplug it.
- Keep the inside of the oven clean. When food or liquids stick to the oven walls, wipe with a damp cloth. We recommend that you do not use harsh detergent or abrasives.
- On the right hand side wall of the cavity is the wave guide cover, microwaves are passed through this to enable your food to cook. It is important that this wave guide cover is kept clean at all times. To do this wipe with mild detergent and water, then dry.
- You should clean the outside of the oven with a damp cloth. Don't allow water to seep into the ventilation openings.
- Do not allow the control panel to become wet. Clean with a soft, damp cloth. Do not use detergents, abrasives or spray-on cleaners on the control panel.
- If steam builds up inside or around the outside of the oven door, wipe with a soft cloth. This may happen when the microwave oven is used in humid conditions.
- Regularly remove the glass turntable to clean it, and wash it in warm soapy water. Regularly clean the turntable support and oven floor. Simply wipe the bottom surface of the oven with mild detergent and water, then dry. You can wash the turntable support in mild soapy water.
- When removing the turntable support of the oven, make sure you put it back properly.
- If the inside of the oven smells, put a cup of water with the juice and skin of one lemon in a deep microwave bowl. Microwave it for three minutes, wipe thoroughly and then dry with a soft cloth.
- Failure to maintain the oven in a clean condition, especially if liquid is left under the turntable, could lead to deterioration of the surface that will adversely affect the life of the appliance that may result in a hazardous condition.

**GUARANTEE**

This product is guaranteed for 12 months from the date of the original purchase. If any defect arises due to faulty materials or workmanship the faulty product must be returned to the place of purchase. Refund or replacement is at the discretion of the store.

The following conditions apply:

- The product must be returned to the retailer with the original proof of purchase.
- The product must be installed and used in accordance with the instructions contained in this instruction guide and any other instructions for use which has been supplied.
- It must be used for domestic purposes only and for its intended use.
- This guarantee does not cover wear and tear, damage, misuse or consumable parts.

This does not affect your statutory rights.

**TECHNICAL SPECIFICATION**

Rated Voltage

230V - 240V ~ 50Hz

Rated Input Power(Microwave)

1200 -1270 W

Rated Output Power(Microwave)

750-800 W

Oven Capacity

20 L

Turntable Diameter

255 mm

External Dimensions(HxWxD)

315mm x 495mm x 395mm

Net Weight

11.2 kg

# THE REFRIGERATOR

---

Modes Of Operation .....	111
Explanation Of Operating Controls .....	111
Starting The Refrigerator Using Gas .....	111
Defrosting .....	112
Shutting Off The Refrigerator .....	113
RMD10.5 and RMD10.5X .....	114
Winter Operation .....	116
Cleaning and Maintenance .....	116
Safety Instructions .....	117



# THE DOMETIC REFRIGERATOR

Before you start using the refrigerator, please read the operating instructions carefully.

## MODES OF OPERATION

The refrigerator is equipped to operate on three power modes:

- > Mains voltage (230V AC)
- > Direct-current voltage (12V DC)
- > Gas (liquid gas propane/butane)

## RM8400 AND RMS8550

Select the desired power mode by the energy selector switch 1 battery igniter type models.

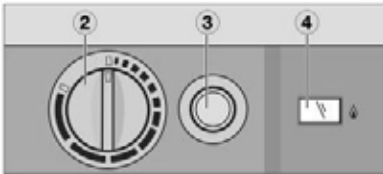
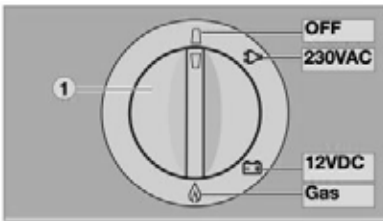

## EXPLANATION OF OPERATING CONTROLS

- 1 = Power On switch/ Energy selector switch  
 2 = Temperature controller  
 3 = Battery igniter (gas)  
 4 = Flame indicator (galvanometer)

Switch on the appliance by turning the energy selection switch 1 clockwise to the desired power source.



In order to prevent discharge of the onboard battery, 12V operation should only be used while the vehicle is running.

## ELECTRICAL OPERATION

### 12V (ON BOARD POWER SUPPLY)

The refrigerator should only be used in 12V DC operation while the vehicle's engine is running, otherwise the onboard battery would be discharged within a few hours.

### MAINS POWER (230V)

This option should only be selected where the supply voltage of the connection for power supply corresponds to the value specified on the data plate. Any difference in values may result in damage the appliance.

### GAS OPERATION (LIQUID GAS)

The refrigerator must be operated using liquefied gas (propane or butane NOT natural gas or town gas). When using LPG please consider that the burner needs cleaning at shorter intervals due to the gas combustion method (annually).

Gas operation is not permitted when traveling in the vehicle.

For physical reasons, gas ignition faults could occur starting from an altitude above sea level of approx. 1,000m/3,280 ft. (This is not a malfunction!)

On the initial refrigerator start-up or after a cylinder change, air may be trapped in the gas line. To purge the air from the line, switch on the refrigerator and any other gas appliances (e.g. stove) for a short time. The gas ignites without delay.

Each refrigerator with manual ignition is equipped with an automatic flame safety valve which interrupts the gas supply after approx. 30 seconds when the flame has extinguished.

## STARTING THE REFRIGERATOR USING GAS

1. Open the valve on the gas cylinder.
2. Open the shut-off valve for the gas supply to the refrigerator.

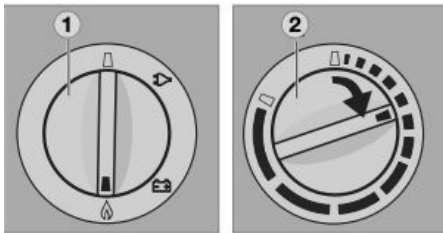

3. Turn the rotary selector "1" to position .
4. Turn the temperature selector "2" clockwise and push in. Keep the selector depressed.
5. Whilst selector is depressed press knob "3" (battery igniter) down and keep it depressed. The ignition process is activated automatically.

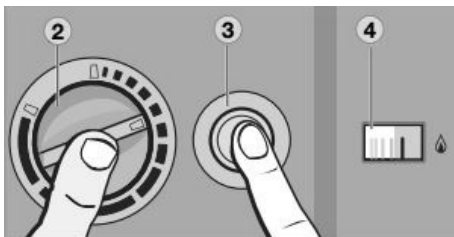

6. Once the flame ignites, the pointer of galvanometer "4" begins moving into the green range. The refrigerator is operational. Keep knob "2" depressed for approx. 15 seconds and finally release it.

## DOOR LOCKING

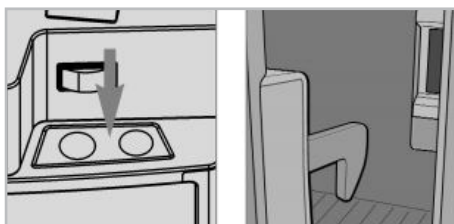

1. Open the door by depressing the locking button and pulling the door towards you.
2. Shut the door by pushing it to close. The snapping into the lock can be heard locking into place.



Once the freezer compartment is removed, an additional storage rack (3) may be installed. The storage rack is a piece of extra equipment and may be obtained from [www.bailey-parts.co.uk](http://www.bailey-parts.co.uk)



Some model layouts may prevent the removal of the freezer compartment.

## DEFROSTING

As time goes by, frost builds up on the fins inside the refrigerator. A layer of frost thicker on one side may occur and does not represent a malfunction. When this layer of frost is about 3 mm thick, the refrigerator should be defrosted.

1. Switch off the refrigerator, as described in the next section, 'Shutting Off The Refrigerator'.
2. Remove all food and the ice cube tray.
3. Leave the refrigerator door open to allow air to enter and to prevent formation of mildew.
4. After defrosting (freezer compartment and fins free of frost), wipe both cooling compartments dry with a cloth.



Ice thawing in the main compartment of the refrigerator runs into an appropriate container at the back of the refrigerator. From there, the water evaporates.



The layer of ice must never be removed forcibly, nor may defrosting be accelerated using a heat source.

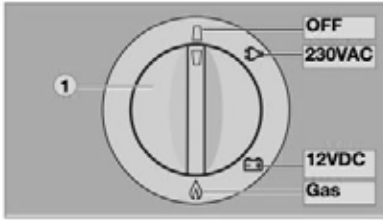







**SHUTTING OFF THE REFRIGERATOR**

1. Set energy selector switch to position OFF; the appliance is switched off.

For further information on the operation of the Dometic 8xxx series fridge please refer to the appliance user manual

## RMD10.5 AND RMD10.5X

The LED display has the following operating and display elements.

Symbol	Description
	ON/OFF button
	Fault indication
	Operating with DC power
	Operating with gas
	Operating with AC power
A	Automatic mode
	Temperature indication
	Energy selection button
	Temperature selection button

### SWITCHING ON THE REFRIGERATOR

- Press on/off button for 2 seconds
  - The refrigerator starts with the last selected settings.

### SWITCHING OFF THE REFRIGERATOR

- Press on/off button for 4 seconds
  - A beep sounds and the refrigerator switches off.

### OPERATING THE REFRIGERATOR

#### CONTROL

- Repeatedly press mode button, until the LED indicates the desired operating mode.
- Repeatedly press temperature selection button, until the desired temperature level is set.

### SETTING THE COOLING CAPACITY

- Repeatedly press temperature selection button until the desired temperature level is selected.

#### NOTE

For ambient temperatures of +15 °C to +25 °C, select the average cooling capacity.

For further information on the operation of the Dometic 10 series fridge please refer to the appliance user manual

# THETFORD N SERIES FRIDGE

## CONTROL PANEL

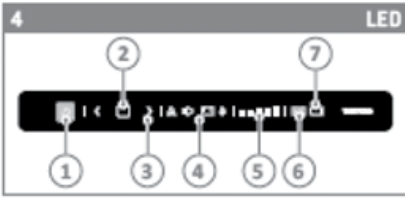

1. On/off button
2. Confirmation button
3. Arrow buttons
4. Energy sources
5. Cooling level indicators
6. Anti-condensation
7. Battery empty (optional)

## SWITCHING ON

Push the on/off button and hold it for 1 second. The light in the on/off button turns blue and the last selected settings with light up.

## TO SELECT ENERGY SOURCE

1. Push the confirmation button (2) and hold it for 2 seconds until the energy source symbols start to blink
2. Push the arrow buttons until the desired source is selected
3. Push the confirmation button with quick touch (press and let go) to confirm your section

## TO SELECT COOLING LEVEL

1. Push the confirmation button (2) and hold it for 2 seconds until the energy source symbols start to blink
2. Push the confirmation button again. The cooling level indicators start to blink
3. Push the arrow buttons to select the desired cooling level
4. Push the confirmation button to confirm your section. Your control panel should now confirm and turn off, leaving a blue light in the no/off button

For further information on the Thetford N Series fridge, please refer to the appliance user manual

## WINTER OPERATION

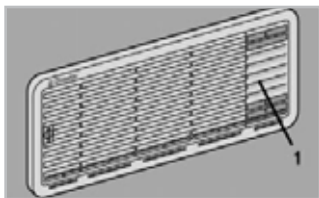

In winter, check that the ventilation grilles and the exhaust duct system (1) have not been blocked by snow, leaves, etc.

When the outside temperature falls below +8°C, a winter cover should be fitted. This protects the unit from excessively cold air which could have adverse effects on the performance of the unit. You should also attach the winter cover if the vehicle is taken out of service for a longer period of time or while it is being cleaned from the outside.

The cover can be purchased from [www.primaleisure.com](http://www.primaleisure.com)

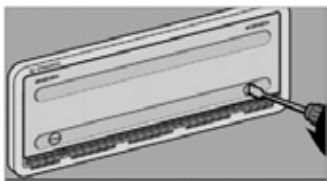

Installation may only be carried out by authorised personnel. We recommend contacting your Dometic Service Centre. EN 1949 stipulates that the appliance's gas equipment and its associated fume system must be inspected after installation and a certificate issued.

When using the fridge for extended periods on gas operation Dometic recommend a seasonal service is carried out by authorised personnel. It is the user's responsibility to arrange for inspections after purchase.

It is recommended that the gas burner be inspected and cleaned as necessary at least once a year.

## CLEANING

Before starting up the refrigerator, it is recommended to clean inside and repeat this at regular intervals. Use a soft cloth and lukewarm water with a mild detergent. Then wipe out the appliance with clean water and dry thoroughly.



To avoid deterioration of materials, DO NOT use soap or hard, abrasive or soda-based cleaning agents. Do not allow the door seal to come into contact with oil or grease.

## MAINTENANCE

In compliance with the applicable regulations, please note that the gas unit and the connected ventilation ducts must be checked by authorised technical personnel after first use and after every other year for compliance with the European Standard EN 1949. A test certificate has to be issued. It is the user's responsibility to arrange this test.

The gas burner must be inspected and cleaned as necessary at least once a year. When using liquefied petroleum gas (tank or refill cylinders) the maintenance interval is reduced to half-yearly or quarterly. Keep the evidence of maintenance work carried out on your refrigerator.

Work on gas and electrical equipment shall be carried out by qualified personnel only.

## SAFETY INSTRUCTIONS

This refrigerator is designed for installation in motorhomes. The appliance has been type approval tested for this application in accordance with the EC Gas Directive.

The refrigerator is to be used solely for storing foodstuffs.



The refrigerator is not suitable for the proper storage of medication. Please observe in addition the instructions in the medication package inserts.

## USER'S RESPONSIBILITY

Anyone operating the refrigerator must be familiar with the safe handling and understand the advice in these operating instructions. Children may only operate the appliance if they have been made aware of how to operate the refrigerator safely and the dangers of incorrect operation.

## DISPOSAL

When disposing of the refrigerator, detach all refrigerator doors and leave the storage racks in the refrigerator. In this way, inadvertent entrapment and suffocation is prevented.

## WORKING UPON AND CHECKING THE REFRIGERATOR

Work on gas equipment, exhaust system and electrical facilities must be carried out by authorised personnel only. Substantial damage to property and/or injury to persons can arise through unprofessional procedures.



Never use an unshielded flame to check gas bearing parts and pipes for leakage.



Never open the absorber cooling unit! It is under high pressure.

## INFORMATION ON COOLANT

Ammonia is used as a coolant. This is a natural compound also used in household cleaning agents (1 litre of Salmiak cleaner contains up to 200g of ammonia - about twice as much as is used in the refrigerator). Sodium chromate is used for corrosion protection (1.8% by weight of the solvent). In the event of leakage (easily identifiable from the strong odour), proceed as follows:

- Switch off the appliance.
- Air the room thoroughly.
- Inform authorised customer services.

## SAFETY WHEN OPERATING THE REFRIGERATOR WITH GAS

It is imperative that the operating pressure corresponds to the data specified on the rating plate of the appliance. Compare the operating pressure of the rating plate with the data specified on the pressure reducing valve of the liquid gas cylinder.



Operating the appliance with gas is not permitted at petrol stations, on ferry boats or while transporting the motorhome. Either by transporter or breakdown vehicle.

## SAFETY INSTRUCTIONS WHEN STORING FOODSTUFFS

No refrigerator of any kind can improve the quality of the food; refrigerators can only maintain the food's quality for a short duration as from the time of storing it. Please observe the following particular conditions for storing food in a refrigerator that is built into a vehicle: Under the below conditions the refrigerator cannot guarantee reaching the temperature needed for perishables. Perishables include all products with a stipulated use-by date and a minimum storage temperature of +4°C or less, especially for meat, poultry, fish, sausages, pre-packed foods.

- A change in the climatic conditions such as temperature fluctuations.
- High temperatures inside the vehicle when it is closed and parked in direct sunlight (temperatures are possible up to 50°C).
- Use of the refrigerator during travel with the power supply of 12v DC.
- A refrigerator built in behind a window and exposed to direct sunlight.
- Storing the products too soon, i.e. shortly after starting up the appliance for use.
- Pack raw and cooked foods separately (e.g. in containers, aluminium foil etc.).
- Only remove the outside packaging of single packs if all the necessary information, e.g. the use-by date, can also be read on the single packs.
- Do not leave cooled goods outside the refrigerator for too long.
- Place the foods with the next use-by date at the front, accordingly.
- Pack away any leftover food and eat at the first opportunity.
- Wash your hands before and after handling any food.
- Regularly clean the inside of the refrigerator.

THE T F O R D N S E R I E S F R I D G E

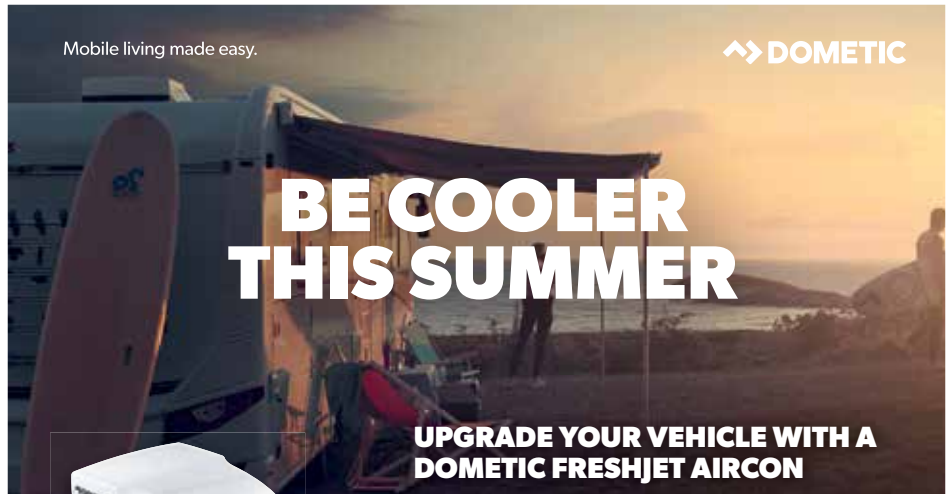

Mobile living made easy.

↗ DOMETIC

# BE COOLER THIS SUMMER

## UPGRADE YOUR VEHICLE WITH A DOMETIC FRESHJET AIRCON



**DOMETIC FRESHJET 2200**

### Rooftop air conditioner

- For vehicles from up to 6m in length, to over 8m in length
- Very low starting currents - FJ 2200 and FJ 3200 with Soft Start
- Air diffuser with two adjustable air flows
- LED lighting, remote control

For more information, please visit:

[dometic.com/freshjet](http://dometic.com/freshjet)



## SURFACE CARE

---

Mirrors.....	120
Bathroom Shower Tap.....	120
T/C Sink.....	120
Ecocamel Shower Head.....	121

## SURFACE CARE

Do not expose the bathroom plastic fittings to cleaning products or abrasive material containing concentrated perfumes, body oil, linseed oil, gritty or abrasive substances/ solvents (white spirits, antifreeze etc). They may cause permanent damage to the material. Always clean the bathroom straight away after use with warm soapy water and a soft cloth. Stubborn stains may be removed with a solution of 1 part water to 1 part lemon juice. Thetford bathroom cleaner is suitable for cleaning the shower and vanity unit plastic items (sinks, shower trays, Thetford toilets etc.).

Domestic cleaning products should not be used to clean the shower/vanity unit plastic items. Some mouthwashes can cause plastic items to crack, therefore for this reason should not be used in conjunction with the bathroom sink.

### MIRRORS

- It is best to clean mirrors with a cleaner that does not contain ammonia. If you are not sure of the ingredients, spray a clean lint free cloth with the cleaner so as not to get the liquid near to the edge of the mirror which is where ammonia would cause the most harm.
- Use a soft, dust-free cloth.
- Try bottled water if your tap is mineral rich.
- For stubborn dirt use an oil-free steel wool pad - carefully and precisely.
- Spray cleaners onto your cloth, not directly onto the mirror.
- Keep the mirror frame dry.
- Never use a razor blade on a mirror, even if the mirror has paint specks on it. .
- If you find black spots on your mirror you may have damaged the silvering behind the mirror's glass.
- Moisture along a mirror's edge can seep in and harm the reflective backing.
- Keep in mind that long-term exposure to sunlight may damage some mirrors.

### BATHROOM SHOWER TAP

Your shower tap has a high quality finish and should be treated with care to preserve the visible surfaces. All surface finishes will wear if not cleaned correctly. The only safe way to clean your mixer is to wipe with a soft damp cloth. Stains can be removed using washing up liquid.

Commercial cleaning products can damage the surface of your fitting, even the non-scratch cleaners.

### T/C SINK

#### GLOSSY FINISH

For the usual daily cleaning of the glossy sink, made of glossy Ocritech, use a damp cloth or sponge with liquid soap, which does not contain abrasive particles.

1. Rinse with water.
2. Use a microfibre cloth to wipe.



**DO NOT USE** abrasive detergents, alcohol, acetone or other types of solvents, because they will damage the material. In case of accidental contact with such solvents, quickly rinse with water.

To keep the surface glossy, apply polish periodically.

## ECOCAMEL SHOWER HEAD

Your motorhome is fitted with an Ecocamel shower head;

- It saves water, energy and money.
- It has a wipe clean head to prevent the build-up of limescale.
- Uses a maximum of 8 litres a minute.

After showering, when the shower is turned off, your Ecocamel shower head simply drains off any excess water through the air intake. Clean your Ecocamel shower head with a damp cloth. Do not use any abrasive or chemical cleaners. Should any scale build up on your shower head's spray plate, de-scale by rubbing the nozzles with your thumb.

### CLEANING THE FACE PLATE



The Ecocamel shower head will fit all motorhome showers and is available from the Bailey Parts department.

# THE THETFORD C262 TOILET

---

Introduction .....	123
Parts .....	123
Preparing Your Toilet.....	124
Cleaning And Maintenance.....	125
Cleaning The Toilet Bowl.....	125
Cleaning the Waste Holding Tank .....	125
Winter Operation .....	126
Storage.....	126

# THE THETFORD C262 TOILET

## INTRODUCTION

The Thetford Cassette Toilet is a high quality product which forms an integral part of your motorhome bathroom thanks to its functional design, combining modern styling and ease of use. Manufactured from high quality synthetic materials, it is a durable, user and maintenance friendly toilet.

The toilet is made up of two parts; a permanently installed toilet and a removable waste holding tank that is accessible from the outside. The removable waste holding tank is located under the toilet bowl and can be removed via a door on the outside of the motorhome.

These operating instructions cover the Thetford Cassette Toilet C262 CWE.

1. Cover
2. Seat
3. Swivelling toilet bowl
4. Blade handle to open and close blade
5. Control panel (Autograph models have an integrated control panel)
- 5a. Flush button
- 5b. Waste holding tank level indicator
6. Pull handle
7. Pour out spout
8. Cap with measuring cup
9. Automatic pressure release vent
10. Vent button
11. Sliding cover
12. Blade opener
13. Waste holding tank mechanism
14. Wheel
15. Access door
16. Water fill door
17. Console with flush water tank (not applicable for Autograph models).
18. Location of waste pump-out system

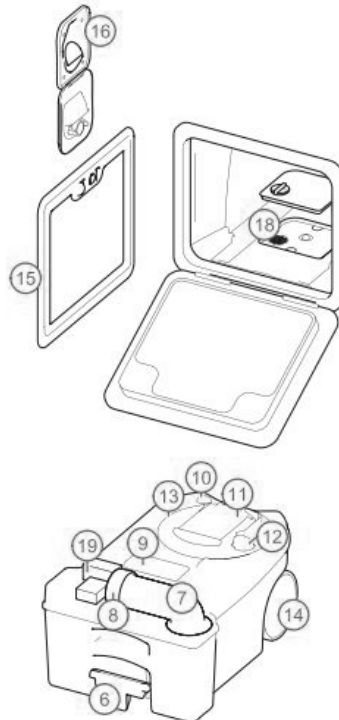

## PREPARING THE WASTE HOLDING TANK

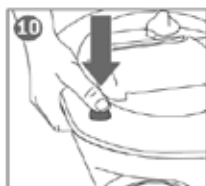

## EMPTYING THE WASTE HOLDING TANK

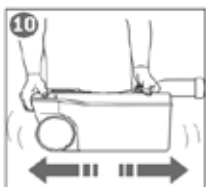
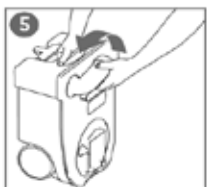
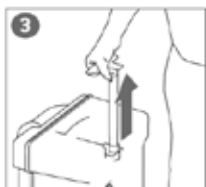
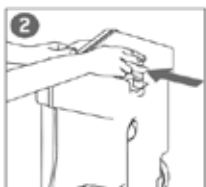



To activate the control panel, press the flush-button once. The control panel display will stay activated for approximately 5 minutes. Run some water into the bowl by pressing the flush button again briefly.

The toilet should be used with the blade open. To open the blade, slide the blade handle under the toilet bowl sideways. After use, open the blade (if still closed) and flush the toilet by pressing the flush button for several seconds (if necessary re-activate the control panel). Close the blade after use. If your toilet has its own flush-water tank, please make sure that you do not travel with a flush-water tank that is too full and with water in the toilet bowl.

Failure to adhere to this notice may result in water damage to your motorhome.

The waste holding tank requires emptying when the red light (LED) on the toilet control display lights up. At that point the waste holding tank only has capacity for two more litres which is no more than two to three further uses.

### CLEANING AND MAINTENANCE

The toilet should be cleaned and maintained regularly, depending on the amount of use. To clean the Thetford toilet, we advise using water and Thetford Bathroom Cleaner. Never use bleach, vinegar or other powerful household cleaners that contain these substances. These may cause permanent damage to the seals and other toilet components.

### CLEANING THE TOILET BOWL

1. Squirt Thetford Bathroom Cleaner into the toilet bowl.
2. Flush the toilet bowl with water and wipe down the rest of the toilet with a damp cloth.
3. To clean the seat and lid, remove by lifting the seat and lid assembly and pulling the round pins (inside the assembly) outwards from the pin holes. After cleaning, replace the seat and lid by positioning the round pins in front of the pin holes and push the lid and seat downwards.
4. To keep your flush water fresh and to prevent deposits forming in your toilet bowl, add a correct dosage of Aqua Rinse in your flush-water tank.
5. Dry with a soft dry cloth after cleaning.

### CLEANING THE WASTE HOLDING TANK

To keep your waste holding tank fresh and clean, Thetford has developed a number of different toilet fluids. Thetford toilet fluids suppress smells, reduce formation of gas, promote breakdown of toilet waste and increase the life span of a mobile toilet. We advise a thorough cleaning of the waste holding tank once each season.

Next to using Thetford's Cassette Tank Cleaner, which is the powerful cleaning agent for the periodical cleaning of the waste holding tank of your toilet, we suggest the following:

1. Remove the removable mechanism from the waste holding tank by turning it anti-clockwise and rinse it under a tap.
2. Remove the cover plate from the automatic pressure release vent by prising it up using a small screwdriver. Use one hand to push the automatic pressure release vent open while holding the float of the automatic pressure release vent on the inside of the tank with the other hand. Push the float upwards, turn it 180° and remove it from below. Remove the rubber seal underneath the float. Rinse the float and rubber seal under a tap. Replace the rubber seal and float for the automatic pressure release vent using the same method in reverse.
3. The rubber seals in the toilet (the lip seal, the mechanism seal, the automatic pressure release vent seal and the cap seal) should be regularly cleaned with water and treated with Thetford High Grade Seal Lubricant. This will ensure that the seals remain flexible and in good condition. If the toilet is not to be used for any length of time, it is important to treat the seals with Thetford High Grade Seal Lubricant after cleaning.
4. Never use Vaseline or any vegetable oil except olive oil. These may cause leakage or malfunction. The lip seal is a part of the toilet that is subject to wear. Depending upon the extent and manner of use, the seals will become less effective and will need replacing periodically.

### **WINTER OPERATION**

You can use your Thetford Cassette Toilet as normal in cold weather as long as the toilet is situated in a heated location. If there is a risk of freezing we advise that the toilet is drained. For environmental reasons the use of antifreeze, such as that used in car radiators, is not recommended.

### **STORAGE**

When you store your motorhome, the flush-water tank should be emptied prior to any extended period of inactivity e.g. winter storage. We advise you to leave the toilet blade open. This will prevent the blade seal from drying out. Also, it is best to unscrew the pour out spout cap as this will also ventilate the waste-holding tank.

Clean your waste-holding tank with Cassette Tank Cleaner and liberally spray the rubbers and valve with Thetford Silicone Spray to extend the life of the cassette.



# Fitted Furniture Configurations

---

74-4 / 79-4I / 79-4F / 79-4T Front Bed Configuration.....	128
79-4I Rear Bed Extension.....	129
69-2 / 81-6 Rear Bed Configuration .....	129
81-6 Front Lounge Bed Configuration.....	130
74-2 / 79-2F Front Bed Configuration .....	131
70-6 Front Bed Configuration .....	132
70-6 Rear Bed Configuration.....	133
59-2 Front Bed Configuration .....	134
74.4 / 76-4 Front Bed Configuration .....	135
74-2 / 76-2 Front Bed Configuration.....	136
75-4 DL Rear Bed Configuration.....	137
69-4 Front Bed Configuration.....	138
60-4 / 75-4I / 75-4T / 75-4DL Front Bed Configuraton .....	139
Manual Drop Down bed operation.....	140
Electric drop down bed .....	142
Adamo retratable table .....	145

# FITTED FURNITURE CONFIGURATIONS

## 74-4 / 79-4I / 79-4F / 79-4T Front Bed Configuration

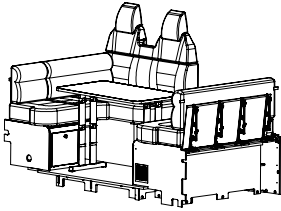

1. The lounge in the seated configuration.

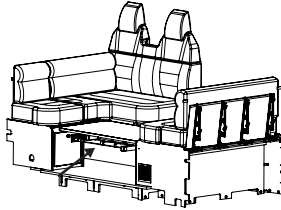

2. Fold table legs in half until it lowers to seat height.

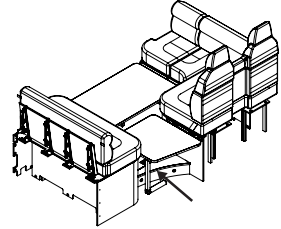

3. Clip coffee table into the latch on the side of bunk and fold lower leg in order to lower the coffee table to seat height.

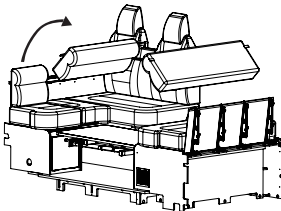

4. Lift, rotate and place the two back rests face-down into position on top of tables.

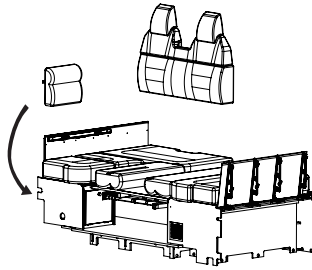

5. Remove the remaining back rests and store underneath bunk.

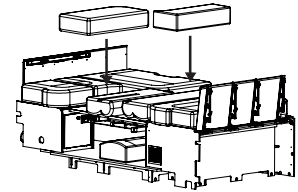

6. Locate the two infill cushions and place in the remaining gaps.

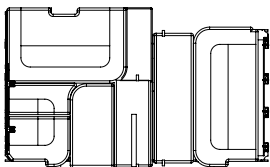

7. The final bed configuration.

**79-4I Rear Bed Extension**



1. The bed is shown in the seated position.



2. Lift up the handle and pull the bed out.



3. The bed is shown extended. Reverse operation to close.

**69-2 / 81-6 Rear Bed Configuration**

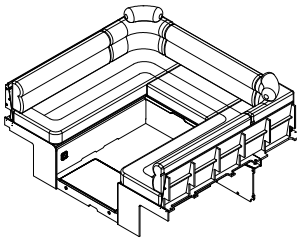

1. The rear lounge in the seated configuration.

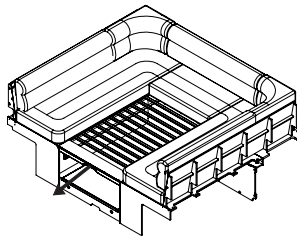

2. Pull out the wooden slat support from the bunk.

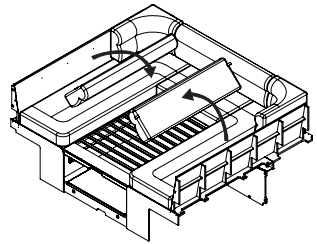

3. Lift, rotate and place the side back rests on to the wooden slats.

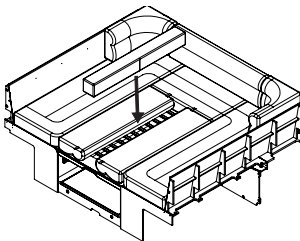

4. Locate the infill cushion from the bunk and place in the centre gap.

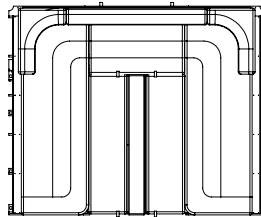

5. The final bed configuration.

## 81-6 Front Lounge Bed Configuration

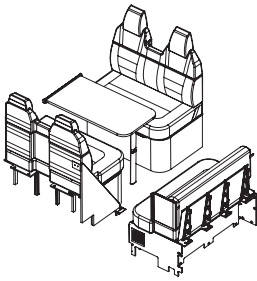

1. The front lounge in the seated configuration.

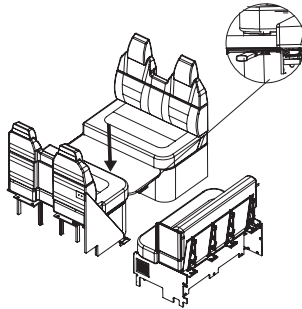

2. Fold table legs in half and lower table until supported by wooden rails attached to the bunk.

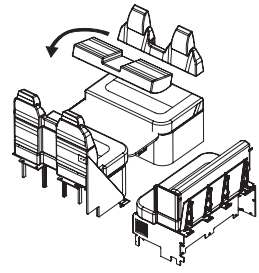

3. Lift, rotate and place the right back rest on to the table.

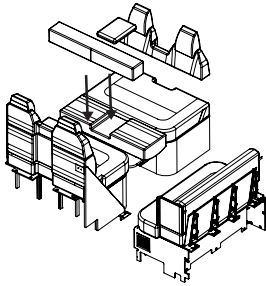

4. Locate the two infill cushions and place in the remaining gaps.

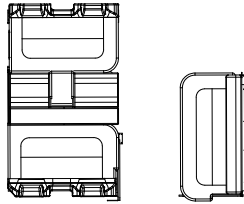

5. The final bed configuration.

74-2 / 79-2F Front Bed Configuration

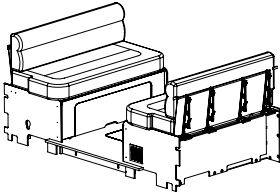

1. The lounge in the seated configuration.

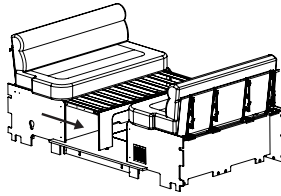

2. Pull out base of right bunk.

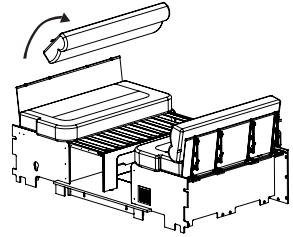

3. Lift, rotate and place the right back rest on to the wooden slats.

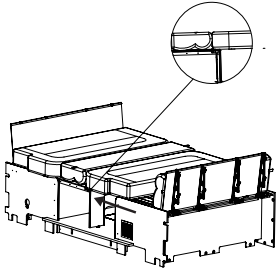

4. Pull left seat cushion outwards to meet the right seat cushion and place it on the wooden slat edge.

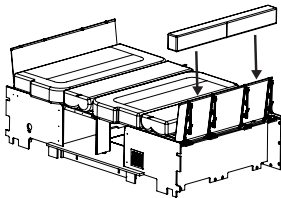

5. Locate the two infill cushions and place in the remaining small gap.

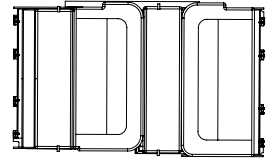

6. The final bed configuration.

## 70-6 Front Bed Configuration



1. The lounge in the travel configuration.



2. Lift the table out of the wall retainer and bend the leg.



3. Place the table kneeling on the floor resting on the runners.



4. Lift up both base cushions, turn over and replace.



5. Slide out both lumbar supports.



6. Place both lumbar supports on the table.

## 70-6 Rear Bed Configuration

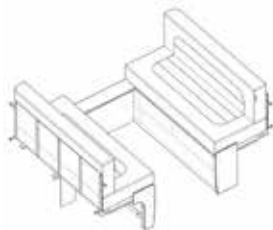

1. The lounge in the travel configuration.



2. Remove the lumbar support cushions.



3. Lift and turn over the base cushions.

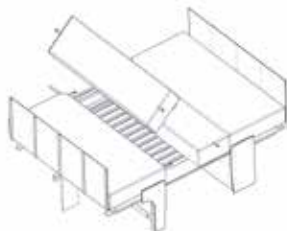

4. Rotate the lumbar support cushions and place in the middle.

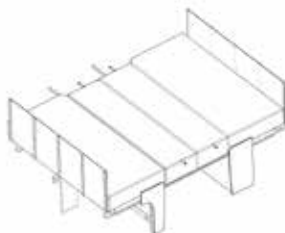

5. Finished rear bed layout.

## 74-4/76-4 Front Bed Configuration

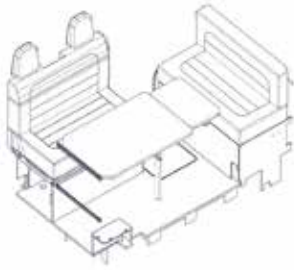

1. The lounge in the travel configuration.

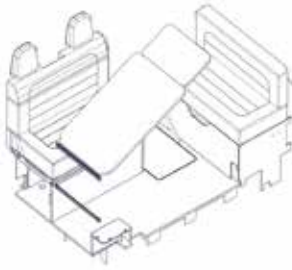

2. Lift the table out of the wall retainer and bend the leg.

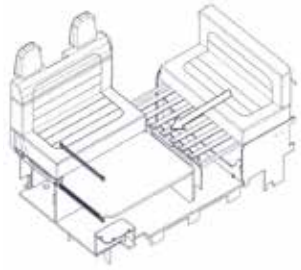

3. Place table on runners. Pull out the underside of the single seat.

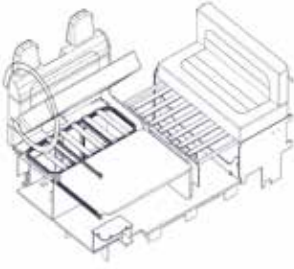

4. Lift up both base cushions, turn over and replace.

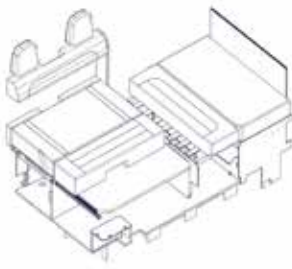

5. Place the back rests in position.

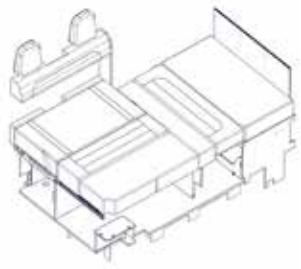

6. Open out both infill cushions and put in place.



**74-2/76-2 Front Bed Configuration**

1. The lounge in the travel configuration.



2. Pull out the underside of the large seat.



3. Pull out the underside of the smaller seat.



4. Lift up both base cushions, turn over and replace.



5. Place the back rests in position.

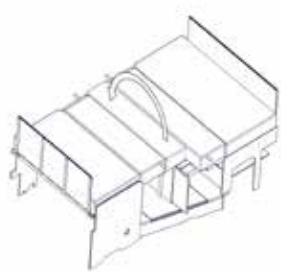

6. Open out the infill cushion and put in place.

## 75-4 DL Rear Bed Configuration

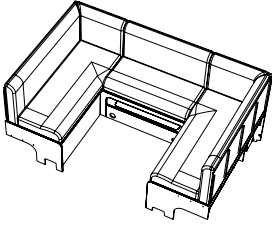

1. The lounge in the travel configuration.

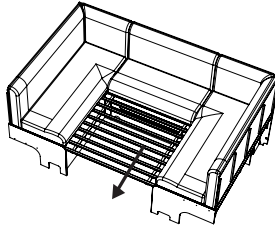

2. Slide out slats from centre seat base.

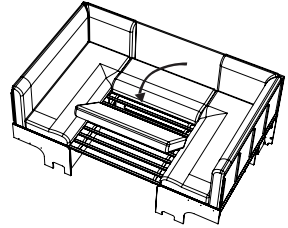

3. Lift, rotate and place centre back rest cushion into position.

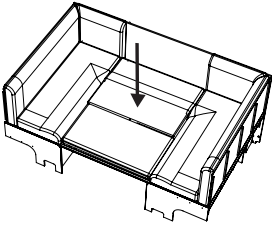

4. Locate the infill cushion and place into the final section of the bunk.

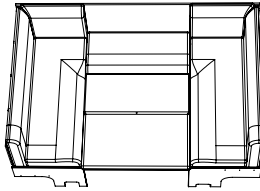

5. The final bed configuration.

## 69-4 Front Bed Configuration

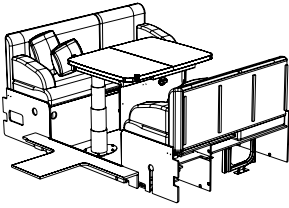

1. The lounge in the travel configuration.

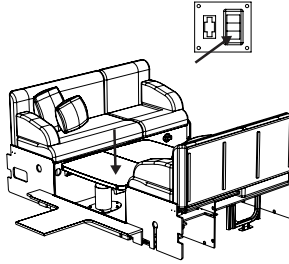

2. Lower the table to bunk height using the table switch.

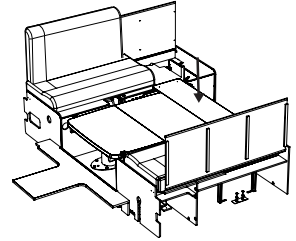

3. Locate wooden extension support and slot into position.

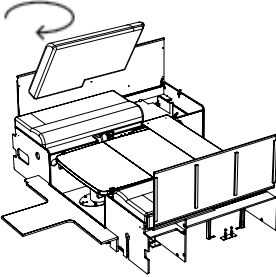

4. Lift, rotate and place the longer offside back rest on to the table leaving space for infills either side.

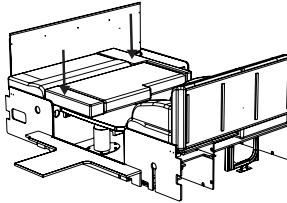

5. Locate the two infill cushions and place into position.

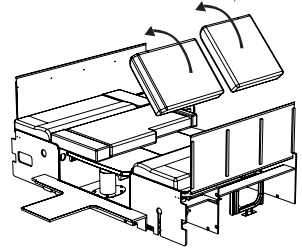

6. Lift and place the two nearside back rests into the final section of the bunk.

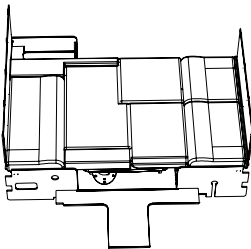

7. The final bed configuration.

## 60-4 , 75-4I , 75-4T and 75-4DL Front Bed Configuration

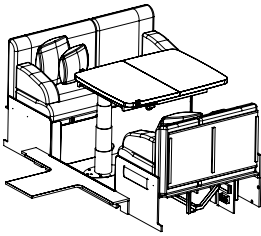

1. The lounge in the travel configuration.

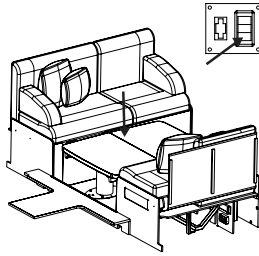

2. Lower the table to bunk height using the table switch.

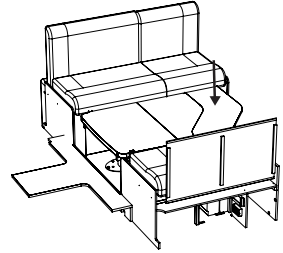

3. Locate wooden extension support and slot into position.

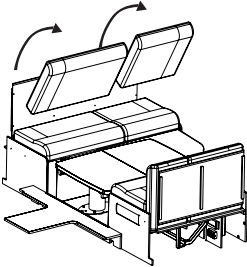

4. Lift, rotate and place the two offside back rests face down on to the table.

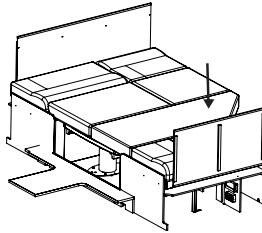

5. Locate the angled infill cushion and place into the final section of the bunk.

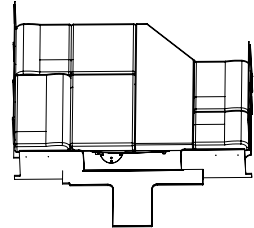

6. The final bed configuration.

**Manual Drop Down Bed - Autograph Only**



1. The drop down bed should always be stored in the up position when not in use and when travelling. All bedding should be removed.

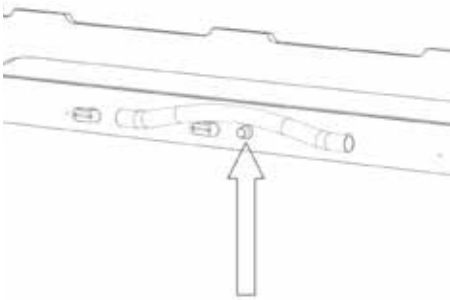

2. To lower or raise the drop down bed, lift the bed slightly while pressing the button.

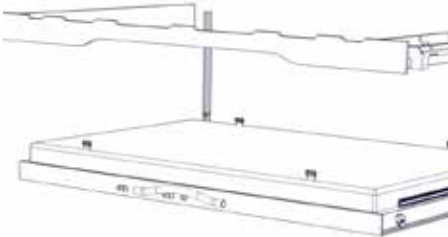

3. The handle should then be used to either lower or raise the bed.

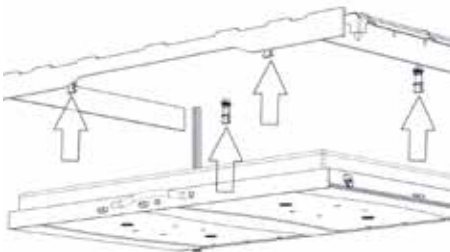

4. As a safety feature the drop down bed includes a net which is secured around the bed when in use.

Attached to the net you will find four plastic clips; two at the front and two at the rear. These clips should be inserted into the plastic receivers attached to the ceiling (as shown).

To see these configurations as animated movies please visit [www.baileyofbristol.co.uk](http://www.baileyofbristol.co.uk) and select your model of motorhome.

**Electric Drop-Down Bed - Alliance Only**

Some models in the range are fitted with electronic drop down beds. These beds are designed and tested to support up to and not exceeding 200kg.

The bed movement is operated from the control panel, positioned above the main door. To operate:

1. Insert the key into the lock and turn clockwise by 90° to enable operation.
2. Press and hold the DOWN arrow to lower the bed.
3. Press and hold the UP arrow to raise the bed for storing.
4. Once the bed reaches the desired position the bed movement will stop; depress the arrow button and turn the key to the OFF position (anticlockwise by 90°).

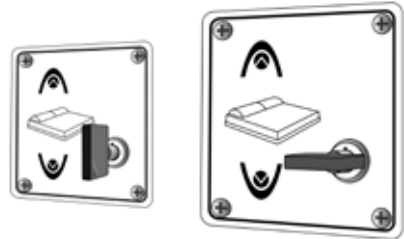

## Safety Protection

The safety protections in place are:

- The key used to isolate the bed movement operation.
- 2 limit switches, one high and the other low which cut-out the mechanical movement.

The bed movement mechanism should only be operated by an adult.

## Emergencies

To manually unlock the bed position when there is insufficient power from the leisure battery, locate the electric motor in the underside bed locker (nearest to the cab). This is accessed from behind the back panel. The motor is fitted with a hexagonal nut which enables manual up and down movement of the bed: turn the hexagonal nut clockwise or counter-clockwise, depending on the desired direction of movement.



Due to the mechanism it is important that the following safety measures are adhered to.

- Do not remain on the bed while the lifting mechanism is in use.
- Do not allow children to play with the lifting mechanism.
- Ensure that the running track of the lifting mechanism is kept clear.
- When lifting or lowering the bed, remove all bedding, except for the fitted sheet.
- Before lifting the bed, raise the mattress and store the fall out nets underneath.

The net is required to prevent falls from height. Use upper bunks for sleeping only with protection against falling out in position. Care shall be taken against the risk of falling out, when upper bunks are used by children, especially under the age of 6. These bunks are not suitable for use by infants without supervision.

### Electric Drop-Down Bed - Adamo Only

Some models in the range are fitted with electronic drop down beds. These beds are designed and tested to support up to and not exceeding 200kg. The bed movement is operated from the control panel, positioned next to the main door or rear lounge cheek.

The bed is programmed to stop at two levels, to allow sleeping for 2 or 4 persons.

The first level is to allow the use of the lower lounge area as a second bed and will require the use of the ladder and bed panels. The second position is to allow the bed to be used at bunk height (no lower bed make up is possible). For 75-4DL both beds are to be used in the lower position.

There is a switch located on the side panel to operate either the front or rear drop down beds.

### 60-4, 69-4 Drop-down Bed Configuration

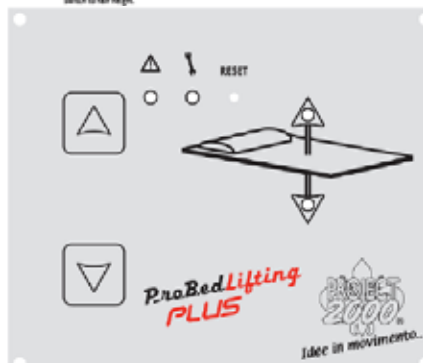
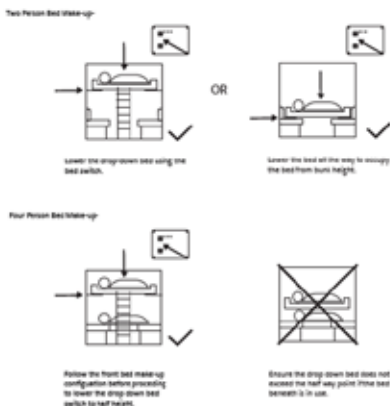

Please ensure all items (incl Flexi lights and kitchen worktop extensions) are clear of the bed trajectory and the PDU access door is open

### To operate:

The bed can be lifted or lowered by pressing the arrow-shaped switches on the front panel. When pressing the UP (arrow up) switch the bed will be lifted and it will go down when pressing the DOWN switch.

Two green LED-lights are located on the controller panel and they light corresponding to the operating direction

The bed will be moving until:

- The switch is released;
- A pre-set stop position is reached;
- The end-of-stroke position is reached.

The bed will move by pressing one of the switches again, unless the end-of-stroke position is reached.

### Low power absorption mode

When the controller is activated the two arrow-shaped LED-lights on the panel will simultaneously switch on.

In order to reduce battery power absorption the controller is programmed to automatically switch to the low power absorption mode 180 seconds after pressing a switch.

When the system switches to the low power absorption mode the two LED-lights on the panel will switch off.

It is possible to switch back to the normal mode by pressing the UP switch. Then it is necessary to keep the switch pressed in order to unlock the safety device described in the following paragraph.

### Protection against unauthorized access

The controller is equipped with a safety device to protect the system against unauthorized access, which also works when the system is not operated and when it is operated in the low power absorption mode.

In order to unlock the safety device and activate normal functions described in the previous chapters, it is necessary to keep the UP switch pressed for about 6 seconds.

Access to normal functions is indicated by the two arrow-shaped LED-lights on the panel switching on.

The safety device will be activated again when switching to the low power absorption mode or when switching off the controller

## Inertia Recovery

When the bed is going down, motor inertia and weight make it possible for the bed to stop in a position which is lower than the pre-set position. In this case, only if the bed stops in a stop position the inertia is automatically recovered, i.e. the bed is lifted until it reaches the pre-set stop position.

The lifting movement is performed after releasing the DOWN switch.

The controller responds by keeping the UP light switched on.

## Trouble shooting

The following paragraphs provide information on how to program and use the ProBedLifting controller.

NOTE: Events might occur while regularly operating the system that may reset the board memory. The most common cause is using the system when the battery is empty. When the memory is reset while operating the system, the controller will lose data related to the current bed position. In order to restore normal functions, it is necessary to bring the bed to the end-of-stroke position after solving the problem that caused resetting (e.g. after recharging the battery).

## Programming

In order for the controller to work properly, it is necessary to set at least one stop position. In this case the only stop position is the lowest position the bed can reach.

The controller enables to set up to a maximum of 5 stop positions. In this case the controller will automatically detect the lowest position among the 5 positions set and will take it as a limit-reference.

The pre-set stop positions are then stored in a flash memory that saves programmed data also in case of power loss.

If the flash memory is empty when switching on the system, the red light will start flashing (flashing speed is 1 second on and 1 second off).

It will only be possible to lift the bed when a new setting is carried out. As soon as the bed reaches the limit switch, it will stop until a new setting is carried out.

## In order to set stop positions:

- 1 Make sure the controller is activated. If the two arrow-shaped lights are on, go to step 2 or keep the UP switch pressed for about 6 seconds until the lights switch on. If after 6 seconds the lights do not switch on, make sure the system is powered; disconnect and reconnect the connector to the system and try again.
- 2 A third hidden switch is located in the middle between the UP and DOWN switches. Press it down and keep it pressed while pressing the UP switch twice, then press the DOWN switch twice and then finally press the UP switch again once. The green light with the wrench icon should now switch on. The switch must be pressed down slowly, it is necessary to keep it pressed for about one second every time. If the green light does not switch on, release the hidden switch and try again.
- 3 If the memory was empty, the red warning light will keep flashing. Before moving on to the following operations it is necessary to reach the end-of-stroke position. The controller does not enable to store any data until the end-of-stroke position is detected.
- 4 Press the UP switch and reach the end-of-stroke position. The bed will automatically stop: do not release the UP switch until the bed has stopped. If the red warning light was flashing, it will switch off as soon as the end-of-stroke position is reached.
- 5 Starting from the end-of-stroke position it is possible to set other stop positions. Press the DOWN switch and reach a position.
- 6 In order to store the stop position press the hidden switch and press the DOWN switch by keeping the hidden switch pressed at the same time. The green lights indicating the bed direction will both switch off and thus communicate the data was stored.

**NOTE:** if data is stored without having reached the end-of-stroke position first, the red warning light will switch on and will be on until the switches are pressed



- 7 If you want to set other positions, move the bed with the UP and DOWN switches and repeat step No. 7 in order to store the other positions. It is not necessary to store positions in a sequence, as the controller will sort them automatically.
- 8 In order to exit the programming mode it is just necessary to press the hidden switch and keep the UP switch pressed. It 5 stop positions are stored, you will automatically exit the programming mode.
- 9 Data are sorted in a sequence and stored in the memory before exiting the programming mode. The green light will switch off after the aforementioned operations are finished and the controller then will be ready for use.

## Resetting the system after warning status

The controller can switch to the warning status for mainly two reasons (the warning status is recognizable thanks to the signal as per table 1):

- a command is sent to the motor but there is no feedback signal from the timer;
- a command is sent to the motor, there is a feedback signal from the timer, but the limit switch sensor is pressed.

The warning status is automatically reset by the controller and the user doesn't need to reset the system. If you do that without eliminating the cause of the trouble, the warning status will be activated again when operating the bed for the first time.

If the operator can detect and solve the problem, the warning status will automatically be reset

TYPOLOGY OF ERROR	Description of the signal and consequences
<b>EMPTY MEMORY ALARM (NO PROGRAMS INTALLED ON THE MEMORY)</b>	The Red (alarm) and the Green (programming) LED blink together, about every half of a second. They keep blinking until you enter the programming mode and reprogram the bed. When in programming, the Red led keeps blinking until the bed is brought in the highest position and the green led is continuously on. If the user exits the programming without saving any position, the 2 LEDs will restart blinking together.
<b>LOW BATTERY ALARM</b>	All the LEDs blink together very quickly for 10 times (about every 0.3 seconds; it stops blinking after about 3 seconds). This alarm self-resets and doesn't lose the position of the bed.
<b>ALARM FOR SWITCHING OFF THE BED DURING ITS MOVEMENT</b>	if there's a complete lack of current during the movement of the bed, when the bed will be switched on again, the green led indicating "up" will blink. This indicates that the bed has lost its position and need to go back to the upper position (touching the limit switch).
<b>ENCODER ALARM (THE BED IS BLOCKED OR MOVES VERY SLOWLY)</b>	The red led blinks quickly (approx. every 0.3 seconds and stops blinking after 3 seconds). This alarm self-resets. It can happen for two reasons. First, the connection with the encoder is lost; second, the movement of the bed is too slow. In the first case, the board loses the position, even if only a few centimeters. In the second case, the system keeps the position in its memory.
<b>LIMIT SWITCH ALARM</b>	The red led blinks very slowly (1 second on - 1 second off). This alarm self-resets and doesn't lose the position of the bed. This happens when the contact with the limit switch is lacking, therefore it will reappear at every movement of the bed until the limit switch problem has been resolved (replacement, wiring connection check, etc.)

### Warning for timer signal - no signal

This specific warning status is indicated by a the red warning light flashing with a higher frequency (flashing frequency is half a second on and half a second off).

The causes can be the following:

- The timer connection cable is damaged;
- A contact in one of the connectors is loose;
- The connector was not plugged in properly;
- A trouble/failure in the motor;

In order to reset this warning status it is possible to reboot the controller once the cause of the trouble has been eliminated or manually run the motor with the specific socket head screw located on the motor. In the second situation, the warning status will be reset when the controller detects the motor running and the controller will be enabled again.

### Warning status for limit switch activated

This specific warning status is indicated by a the red warning light flashing with a lower frequency (flashing frequency is two seconds on and two seconds off).

The causes can be the following:

- The limit switch sensor is kept pressed;
- The limit switch connection cable is damaged;
- A contact in one of the connectors is loose;
- The connector was not plugged in properly;

This warning status will automatically be reset once the cause of the trouble has been eliminated. If, for instance, the sensor was kept pressed, the warning status will be reset as soon as the sensor is released. Or, alternatively, if the problem was caused by a damaged cable, the warning status will automatically be reset once the cable has been replaced or repaired.

**NOTE:** If the bed was manually moved, the first operation to carry out is bring it to the end-of-stroke position in order to ensure proper functioning.

### The Adamo retractable table.

The Adamo range of vehicles has an electric retractable table, which is controlled by a switch beside the habitation door or on the kitchen switch panel. The table top unfolds and has the ability to slide and rotate.

### To use the electric table

While the table top is in its storage position, press the table power switch (located by the habitation door) to the up position and hold until desired height has been reached ensuring no objects are blocking its path. Pull out the metal support arm from under the table, unclip the retention strap and unfold the table leaf. To rotate and slide the table depress the lever underneath the table until the desired position is achieved. The storage of the table is the reverse of above. This must be done before any travel. The table will not function with the engine running

Should the table be forced to move when it is clashing against something, the fuse will blow and the table unable to operate. The fuse is located in the electrical box, underneath the front bunk.

### Caution:

- When traveling the table must be stowed in the lowest position, with the travel clips engaged.
- Ensure table lock is engaged when travelling, to prevent swivel movement
- Ensure leaf support is pulled out, before unfolding table leaf

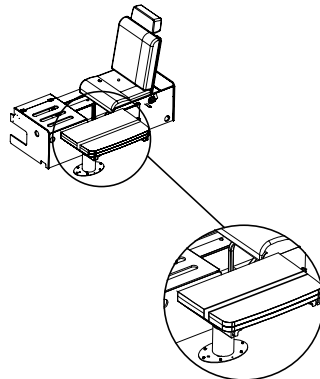

Ensure the table strap is attached securely before travel.

FREE STANDING TABLE



Dependant upon motorhome model you may have been supplied a free standing table. (Tables designs may differ slightly dependant on the age of your motorhome).

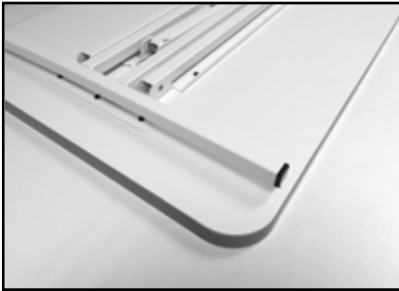

1. The table should be laid upside down on a flat surface.

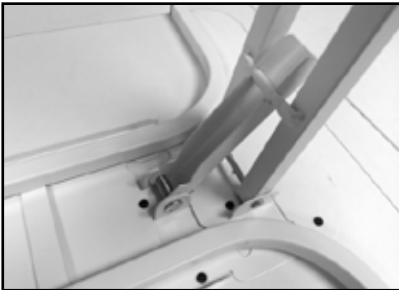

2. Raise the leg to its vertical position until the securing bar locks in place.



3.Repeat the process with the other leg.



Always erect the table upside down due to a finger trap hazard being present at the base of the hinge/ leg (Fig 1/2). When erected the right way up the weight of the legs will cause them to fall into place. This action poses a finger trap hazard in and around the hinge.



## ROOF LIGHTS

---

Using the Midi/Mini Heki.....	148
Using the Mini Heki S.....	149

**USING THE MIDI HEKI****To OPEN**

1. Push button (1) to release bar (2).
2. Push bar into one of the rest positions.

**To CLOSE**

3. Complete the above steps in reverse.
4. To ensure roof light is not blown open the handle must be pushed up past the button which then springs forward sufficiently to secure handle.

**CLOSING THE ROLLER BLINDS**

1. Take hold of the recessed grip on the rod and pull it towards the rod on the other side with the pivot until they both click into one another.
2. Select the required position by moving the two latched-roller blinds at the same time.

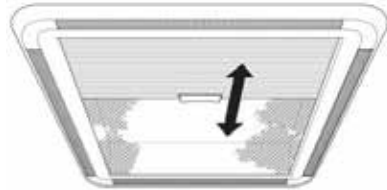
**OPENING THE ROLLER BLINDS**

1. Pull the roller blind so that the blind with the recessed grip is completely extended.
2. Separate the roller blinds by pressing the pivot.
3. Guide the roller blind back using the recessed grip. Do not let the roller blind spring back.

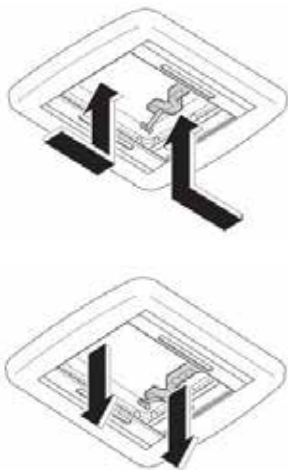

There is a risk of damage due to a build-up of heat between the roller blind and the window. In strong sunlight only close the blackout roller blind two thirds of the way.

**USING THE MINI HEKI****To OPEN**

1. Squeeze the black section of the handles down into the white section of the handles.
2. Push the roof light upwards.
3. To achieve the tilt half opening position, only push one side of the rooflight upwards.

**To CLOSE**

4. To close repeat the above steps in reverse.

**MPK ROOFLIGHT**

The MPK rooflight is situated in the bathroom of your motorhome over the shower compartment. It is fitted with a fly screen for your comfort. The fly screen is hinged, allowing you access to the handles that enable you to raise the rooflight's dome for ventilation.

To raise the dome pinch the black parts of the handle against the other half on both sides and push upwards. Both sides can be raised or just one, depending on your preference.

**ROOF LIGHT MAINTENANCE**

Clean roller blinds with mild soap and plenty of water.



The roof dome may cloud over in bright sunshine. It will become clear again as soon as it cools down.

**SAFETY**

- If faults or disturbances occur, consult a specialist workshop immediately.
- Risk of breakage, do not tread on the acrylic dome.
- Before starting your journey, check that the roof window is locked properly.
- Before starting your journey, check the roof window for damage (such as tension cracks in the acrylic).
- Do not open the roof window while driving.
- Do not open the window in strong wind or rain.
- Close the roof window if it rains or snows.
- Do not leave the vehicle with the roof window open.
- Keep the roof window free of snow and ice.

**MAINTAINING AND CLEANING THE HEKI ROOF LIGHTS**

Do not use any sharp or hard objects for cleaning since they may damage the acrylic. Only use cleaning agents that are approved by the manufacturer.



It is recommended that any elevating roofs be raised when the motorhome is used for habitation purposes.

**GUARANTEE**

The statutory warranty period applies. If the product is defective, please contact your Bailey Retailer

FAULT	Possible cause	Suggested remedy
The roof light does not close completely.	Dirt between the acrylic and frame	Clean the window. Remove any leaves and twigs between the acrylic and frame.
The fly screen or blackout roller blind cannot be moved.	Dirt on the side guides	Clean the side guides.

## THE REMIS WINDOW BLINDS

---

Operating Your Motorhome Habitation Blinds .....	152
Cleaning .....	152
Remis Concertina Cab Blinds.....	153



# THE REMIS WINDOW BLINDS

## OPERATING YOUR MOTORHOME HABITATION BLINDS



Blinds should not be in the down position when the vehicle is travelling or when in storage for extended periods.

The sun screen is housed at the bottom and the fly screen at the top of the blind. To open either hold the cross bar and pull up or down. Both blinds can be fully extended to totally cover the window or can meet at any position to give sun shading/privacy and protection from insects entering the vehicle.

The blinds are pre-set to the correct tension. If re-tensioning is required please follow these steps:

1. The blind needs to be taken down from the wall by unscrewing the 4 corner screws.
2. Lay the blind face down on a table with the cross bars of both blinds meeting in the middle. The black cords re-tension the fly screen and the white cords re-tension the sun screen.
3. The cords are fixed at either side with a screw. Loosen this screw and gently pull the cord 5mm tighter and repeat on the other side ensuring the cross bar is level.
4. Test the tension. This process can be repeated if necessary.
5. The blinds over the kitchen sink and in the bathroom are of a different construction and can be re-tensioned while fixed to the wall. On the side of the cassettes are two plastic screw heads. Using a screwdriver turn these gently clockwise until the correct tension is reached. Test the tension after each turn.

## CLEANING

- Avoid using aggressive cleaning agents (solvents/abrasives).
- Clean the frame elements of the front and side systems with a damp cloth and mild soap solution.
- Blinds should only be dusted lightly with a soft cloth.

## REMIS CONCERTINA WINDSCREEN BLIND

### OPENING AND CLOSING THE CAB BLINDS (IF FITTED)

Due to the nature and angles that these blinds inhabit, it is important that they are opened and closed in the correct manner.

To release the windscreen blind pinch together both buttons within the black handle on the A post.

Pull both sides into the middle of the windscreen so the magnets make a connection.

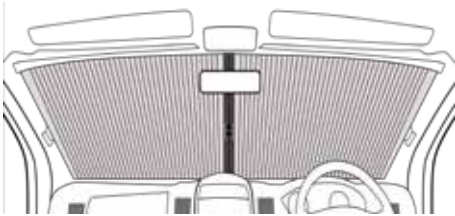
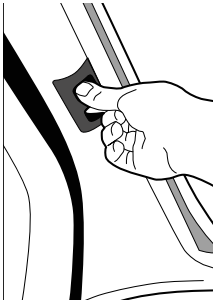

To open, pull the handles apart and pull them back to their resting position. Lock the handle in place by pushing it into the frame.



Always ensure that blinds are locked in place before travelling.

## REMIS CONCERTINA DOOR BLINDS

To release the windscreen blind pinch together both buttons within the black handle on door window frame.

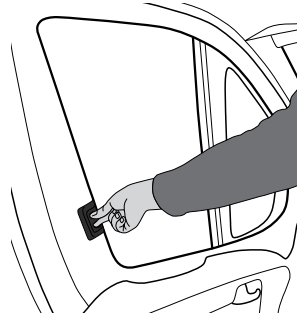

Pull the blind across the window so the magnets make a connection.

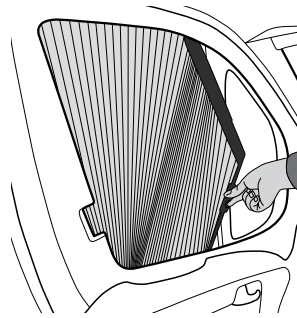

The below picture shows the closed door blind.

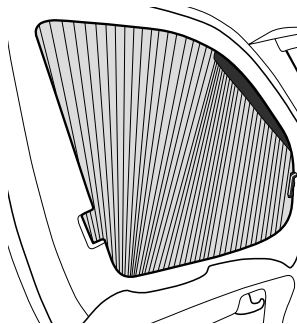

## THE THULE AWNING

---

Opening The Thule Awning .....	155
Closing The Thule Awning .....	156
Maintenance.....	156

## THE THULE AWNING

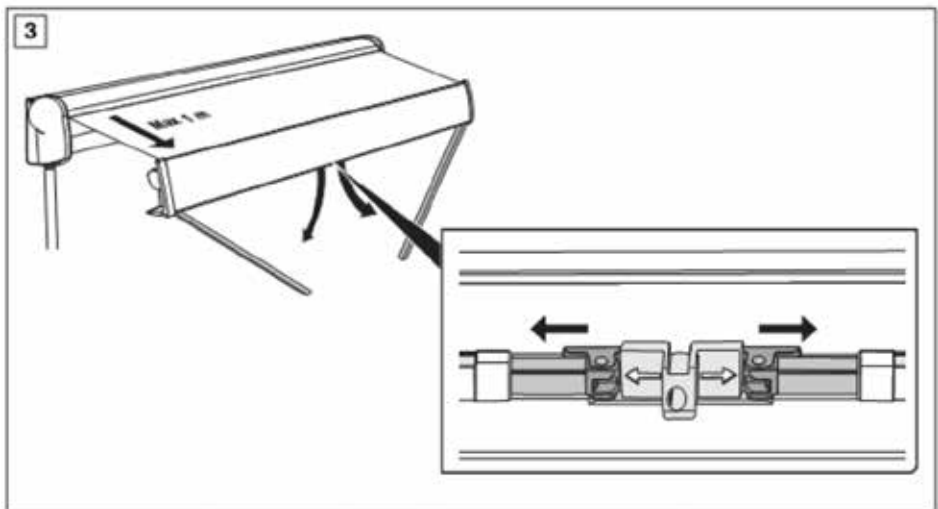
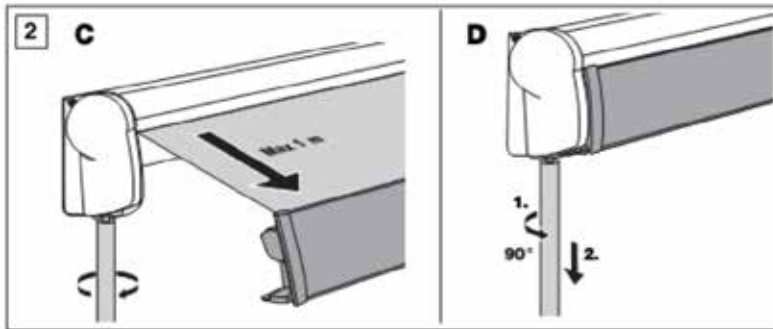
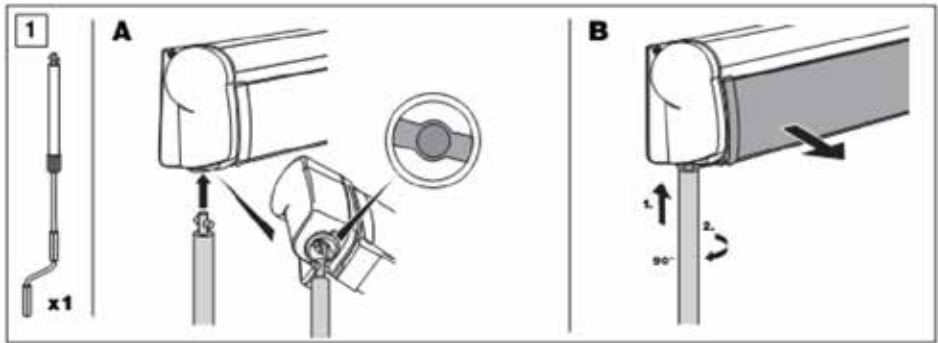

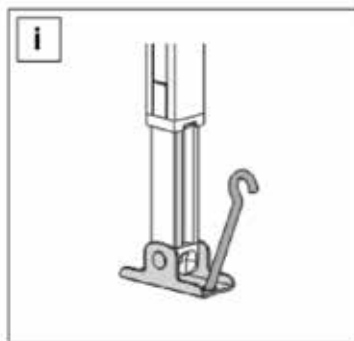
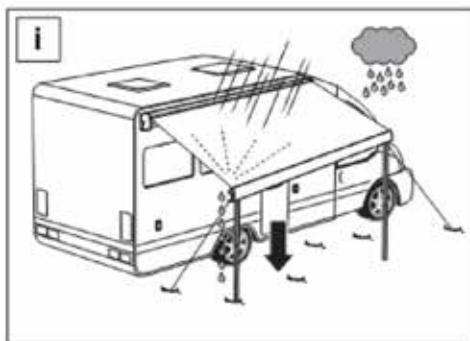
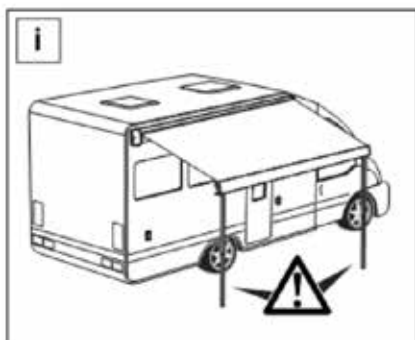
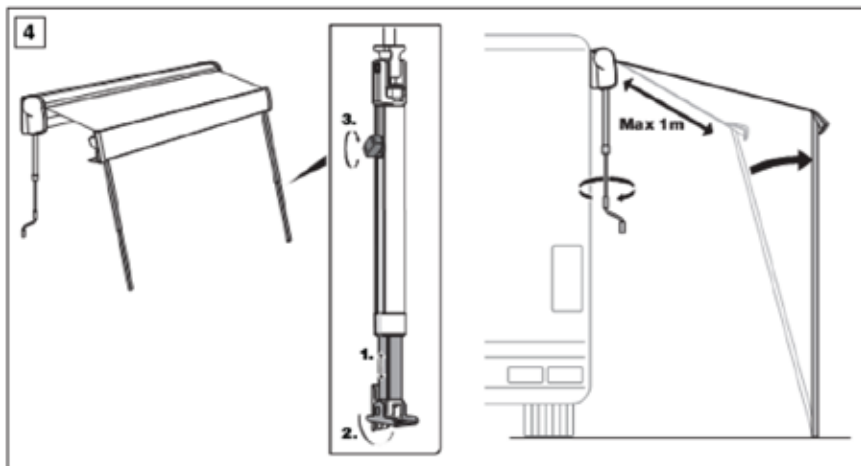

## MAINTENANCE

Make sure that your awning is completely dry and clean before closing it. The remaining humidity could cause stains. If however you have no choice but closing the awning when it is still wet, make sure to open it for drying within 12 hours maximum. If most of the dirt is superficial it can be removed with clean water and a cloth or a brush. If the fabric is very dirty, add some light cleaning detergent. Be aware never to use any aggressive chemical substances and never clean the fabric with a high pressure machine. We recommend not to use the awning at a temperature below 0°C.

## MAINTENANCE

---

How To Clean Your Motorhome.....	158
Cleaning Polyplastic Acrylic Windows .....	158
Cleaning Stainless Steel Sink.....	158
Cleaning Taps .....	159
Cleaning Tecnoform Locker Doors And Worktops.....	159
How to Prevent Condensation .....	159
Prepare Your Motorhome For Cold Conditions.....	159
Storing Your Motorhome .....	159
Preparing Your Motorhome for Winter .....	159
Modifications Made To Your Motorhome .....	160
Spares and After-Sales.....	160
The Motorhome End-Of-Life Policy .....	160
Bulb Replacement.....	160
Thule Electric step.....	162

## MAINTENANCE

### How To Clean Your Motorhome

The exterior of your motorhome is very durable and easy to clean owing to its high gloss properties. To maintain a showroom finish the motorhome and the parts need to be washed using motorhome cleaning solution (bespoke Bailey cleaning products are available at [www.primaleisure.com](http://www.primaleisure.com)). Avoid using strong alkaline (e.g. tri-sodium phosphate) or acidic cleaners or abrasives. Waxing the components once or twice a year with a good grade paste wax will help to maintain the colour and finish.

To avoid scratching, wash your motorhome by hand using a sponge with plenty of cleaning solution. Always rinse away any cleaner.

Dry the vehicle with a chamois or a microfibre cloth.

It is imperative to ensure that the area surrounding the rooflight is completely dried; this will avoid both condensation and damp collecting around the perimeter.



Do not use a mechanical brush washing system such as a car wash.



Never pressure wash your vehicle. This may cause unwanted damage.



Do not use solvents or acrylic cleaners. They may cause a chemical reaction with the material of your motorhome.

Under no circumstances should you use any abrasive agents, methylated spirit, white spirit or other solvents to the exterior of your motorhome.

No touch up painting should be carried out prior to consulting with a Bailey Service Centre for approved methods.

All items stored in the gas bottle storage locker must be secured to prevent impact damage to the inside of the body panel when the vehicle is in motion.

Do not allow any chemicals, toilet or otherwise, to spill or leak into the gas box floor. Before placing items in the cradle ensure that the tray is clean and free from any debris. Cleaning should only be carried out with warm soapy water.

The use of high-pressure water jets to clean your motorhome will invalidate your warranty.

### Cleaning Polyplastic Acrylic Windows

The windows fitted to your motorhome are manufactured from high quality acrylic using the latest plastic processing methods.

For cleaning, use only generous amounts of water to wash away dust and road grit etc. Then use a soft cloth and warm soapy water and gently remove the remaining dirt. Avoid abrasive cleaning materials and detergents.

As with all plastic materials, acrylic should not be allowed to come into contact with chemicals such as paint remover, fly spray, acetone, dish washer detergent or car cleaning detergent. Never polish with a dry cloth.

During high sun do not close the window blinds completely and open the windows into the ventilation position.

While the vehicle is in motion please ensure that the windows are fully closed (this information is also detailed on stickers on the windows).

### Cleaning Stainless Steel Sink

The stainless steel sink will need little maintenance other than cleaning immediately after use. Most deposits can be removed by washing with soap or mild detergent and hot water, followed by a clean water rinse and drying with a soft cloth to prevent water spotting.

For more tenacious deposits a non-abrasive multi-purpose cream cleaner should be used, followed by a rinse with clean water.

Tannin stains can be removed by a solution of washing soda and water applied with a soft cloth/sponge, followed by a rinse with clean water to remove any residues and dry with a soft cloth. When cleaning with anything other than water, be careful not to get the solution onto your kitchen worktop.

Scratching will be most noticeable on highly polished components. These marks are usually only superficial and can be removed with a proprietary stainless steel cleaner/polish. If the surface has a directional polished grain always clean along the grain and not across it.

Always avoid bleach and trigger dispense products and never use wire wool or leave wet cloths, pads or containers on the surface as they may form water marks.



To preserve the appearance of your appliance we recommend not to store plastic bowls or mats in the sink. This is particularly the case when travelling because vehicle movement may cause the plastic bowl to vibrate/rub against the surface and leave marks.

### CLEANING TAPS

Clean and wipe with a soft soapy sponge, then rinse and wipe dry. Do not use an abrasive cleaner, scouring pad, powder or wire wool to clean the tap and shower mixer. Do not use any de-scaling agent.

If you live in a hard water area, limescale may build up around the spout of your tap. Clean this off with either lemon juice or vinegar. Do not attempt to remove this with either a knife or any other sharp implement as this will damage the surface.

### CLEANING TECNOFORM LOCKER DOORS AND WORKTOPS

Wipe the doors with a soft, slightly damp cloth (not wet) and then dry them with a dry cloth. Worktops can be wiped with a wet cloth and are more resistant to water than the locker doors.



Petrol, thinners, abrasive products, chemically treated cloths and detergents may damage doors and should not be used.

### HOW TO PREVENT CONDENSATION

Condensation is the change of water from its gaseous form (water droplets) into its liquid form. Condensation generally occurs in the atmosphere when warm air rises, cools and loses its capacity to hold water vapour. As a result, excess water vapour condenses to form droplets. Condensation normally occurs in the winter when the motorhome is cold and skylights, windows and doors are opened less often; this means that moist air cannot escape. It is important to try and provide ventilation so that moist air can escape and to use the heating responsibly.

Provide ventilation so that warm air can escape:

- Opening a window to provide good ventilation of kitchens when washing, cooking or drying damp cloths is essential.
- If it is not possible to use the space heater, open the skylights or windows slightly but keep the main door closed as much as possible.
- After showering, keep the bathroom door closed and the window or the skylight open long enough for the room to dry.

### PREPARE YOUR MOTORHOME FOR COLD CONDITIONS

Your motorhome is fully climatized having achieved the BS EN 1646-1:2004+A1:2008 standard climatic testing to Grade 3 standard.

- Make sure that all plumbing pipes, drains, and water supply appliances within the motorhome are properly drained.
- Try to cover as much as possible the underside of the motorhome to prevent snow from collecting and packing up underneath. This will help to prevent damage to the tyres due to the weather.
- For motorhomes with drop down beds it is advised to lower the bed to the midway position to reduce the change of condensation gathering on the mattress.

### STORING YOUR MOTORHOME

The following applies whenever your motorhome is stored, particularly during winter months.

- Do not leave your vehicle near trees or latch-type gates due to possible wind damage.
- Keep any grass around the floor of the motorhome short to maintain airflow and stop any possible damp getting into it.
- It is advised that the motorhome is ventilated regularly throughout the winter storage period, opening windows, doors and rooflights where possible.
- All moving parts should be checked for free operation.
- Clean all cooking appliances and the refrigerator before parking up the vehicle.
- Charge up the onboard battery every 2 months.
- Leave the refrigerator door open. Leave the furniture and locker doors open to allow air to circulate fully.
- Ensure that the entire water system is thoroughly drained.



## PREPARING YOUR MOTORHOME FOR WINTER

Freezing in winter may cause damage to the Whale tap. To avoid this damage, ensure that the system is completely drained:

- Drain the fresh water tank using either the pump or a drain valve.
- Turn the pump on and open all taps and the shower mixer (including the drain valve) and allow the pump to purge the water from the system.
- Turn off the power isolator switch for the water pump.
- Remember to leave all outlets open to avoid any damage.
- Lift up the lever of every tap and leave it in its central position.

## MODIFICATIONS MADE TO YOUR MOTORHOME

Owners need to be aware that carrying out DIY modifications to your motorhome may, in certain circumstances, invalidate the warranty cover and could also affect the safety and structure of the vehicle.

Never allow modification of electrical or LPG systems and appliances except by qualified persons. Care should be taken that any additional equipment or appliances are installed in accordance with the appliance/equipment manufacturer's instructions. In the interest of safety, replacement parts for an appliance shall conform to the appliance manufacturer's specifications and should be fitted by him or his authorised agent.

## SPARES AND AFTER-SALES

There are numerous parts and accessories available for your motorhome either from your Bailey retailer or through the Prima Leisure website ([www.primaleisure.com](http://www.primaleisure.com)).

You are more than welcome to contact the parts website for anything you may require. However, if it is a safety or warranty critical item, you will need to obtain it from your Bailey retailer who will fit the component for you.

In the interest of safety, replacement parts for an appliance must conform to the appliance manufacturer specifications and should be fitted by him or his authorised agent.

## THE MOTORHOME END-OF-LIFE POLICY

After many years in service you may decide that your motorhome has become beyond economic repair and should be disposed of. Please ensure that you comply with the end-of-life vehicle legislation and take it to an authorised treatment facility where it will be properly dealt with to minimise any negative environmental impact. The transaction will be logged by the DVLA, identifying that you are no longer the owner of the vehicle.

## BULB REPLACEMENT

Outline Marker Light.

- 1: The Lens is retained with 2 spring catches, one towards the top of the light and one towards the bottom, these can be seen through the clear portion of the Lens
- 2: At the bottom of the light is a small slot, in order to remove the lens place a small flat bladed screwdriver into the slot and carefully lever the lens away from the base of the light, you will be able to see when the lens has become loose through the clear part of the lens.
- 3: When the bottom of the lens is loose gently push the lens upwards to clear the top clip and gently remove the lens.
- 4: Underneath the lens is a grey cover which partially covers the bulb gently remove this cover. There are no clips on this cover do not use force to remove it.
- 5: The bulb is held between 2 spring loaded stainless contacts, very gently remove the bulb being careful not to break the glass and replace with a 12volt C5W bulb of the same length again being careful not to break the glass.
- 6: Replace the grey cover which can be fitted in either direction, making sure it sits flat on the base of the light.
- 7: With the Red half of the lens to the rear of the vehicle carefully fit the lens back on the base. Make sure the top catch is engaged with the lens (this can be checked by looking through the clear part of the lens) before pressing the bottom of the lens over the lower catch to fully engage both bottom and top catches. Check that the lens is secure.

**REAR FOG LIGHT**

- 1: Reach under the rear bumper located behind the light unit.
- 2: Push forward the central light housing until it releases from the reflector.
- 3: The bulb housing is easily removed by twisting anti-clockwise
- 4: Replace with new bulb same type and rating, refitting is reverse of above.

**THE ADAMO REAR LIGHT CLUSTER.**

- 1: Remove the 4 screws (2 above, 2 below) securing the light cluster.
- 2: Remove the cluster from the bumper. The bulb housings will be visible from the rear of the cluster.
- 3: Locate faulty bulb and rotate the bulb housing 90 degrees anti clock wise to release
- 4: Replace with new bulb same type and rating, refitting is reverse of above.

# THULE ELECTRIC STEP

## OPERATION

- The Thule step is operated by the rocker switch located inside the habitation door of your motorhome.
- The maximum static load it can withstand is 200kg.
- When using the step you must press and hold the switch until the step is fully extended. Never use the step in a partial state of opening. This will lead to damage to the motor.
- Always check the step is fully retracted before departure!

## MAINTENANCE

Dirt and frost can prevent the Thule Step from operating properly. In this case the moving parts should be cleaned or defrosted. Keep the footboard clean and check the operation of the switch regularly.

It's possible to take out the footboard in order to clean the step inside.

- Retract the footboard by the lever switch, when possible not fully. Disconnect the power to the step.
- Disconnect the 2 drive rods from the footboard by removing the clips at the bottomside of the foot- board.
- Take away the 2 black stops with the screws at the outside.
- Take out the footboard and clean.
- Brush the inside of the step and remove the dirt with a vacuum cleaner. Never use a high pressure cleaner or water.
- First reconnect the driving rods. Followed by fixing the endstops.

## IN CASE OF ELECTRICAL FAILURE

- If the step does not retract by motor it is possible to take out the footboard.
- Never retract or extend the step by hand without this mechanical disconnection.

## Current drawn

- The Thule Step motor uses 2A during operation.
- Note: If the switch is kept pushed when fully extended or retracted, it uses 9A.

## ACCESSORIES

- Electronic control unit (308812) for automatic extension and retraction when opening or closing the door.
- Relay for automatic retraction (x10) (308200) that prevents operation of the Thule Step and keeps it retracted whilst driving.

## SAFETY INSTRUCTIONS

Read this safety instructions thoroughly, before starting up the device and store it in a safe place. If the device is handed over to another person, this manual is to be handed over along with it.

Safety instruction: failure to observe this instruction can cause material damage or personal injury and impair the proper functioning of the device.

Safety instruction relating to danger emanating from electrical currents or voltage: failure to observe this instruction can cause material damage or personal injury and impair the proper functioning of the device. The manufacturer will not be held liable for claims for damage resulting from the following:

## FAULTY ASSEMBLY OR CONNECTION

Damage to the appliance resulting from mechanical influences and excess voltage

Alterations to the device without express permission from the manufacturer

Use for purposes other than those described in the operating manual

To prevent short circuits, always disconnect the negative terminal of the electrical system before- working on the vehicle. If the vehicle has an additional battery, its negative terminal should also be disconnected.

Inadequate supply cable connections could result in short circuits with the consequence that:

- cable fires occur
- the airbag is triggered
- electronic control devices are damaged
- electric functions fail (indicators, brake light, horn, ignition, lights)

Installing the wrong fuse can cause cable fire in case of a short circuit or malfunction!

### MANUAL OPENING

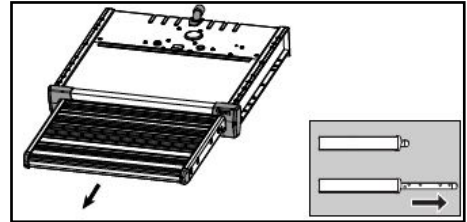
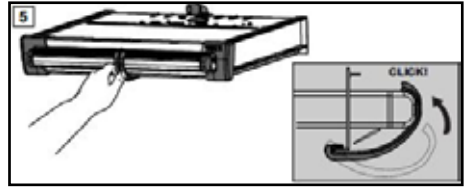
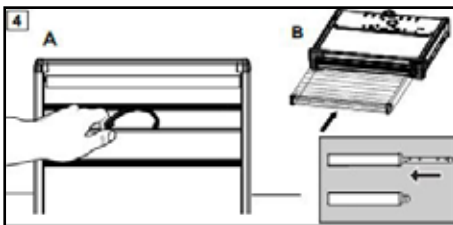
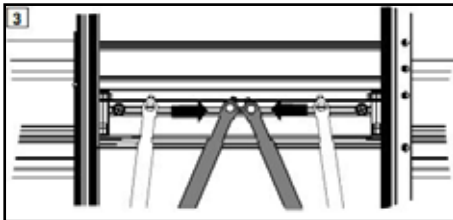
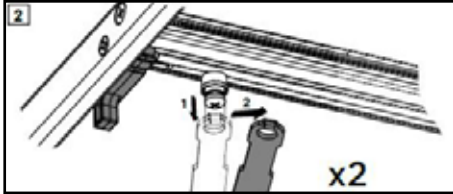
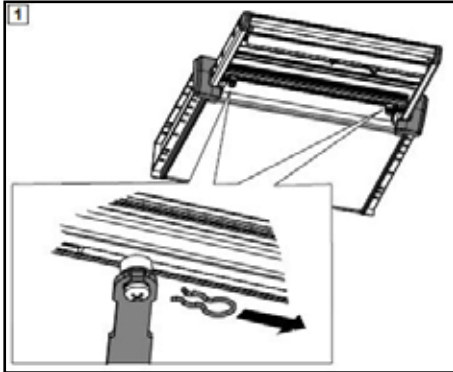

### MAINTENANCE

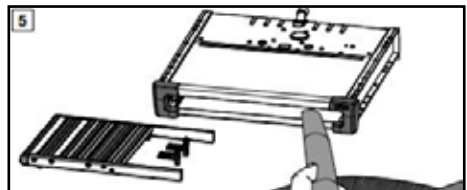
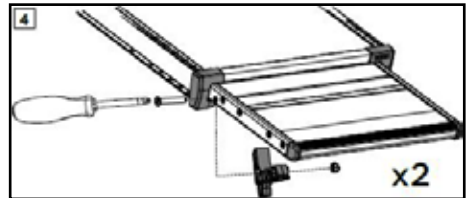
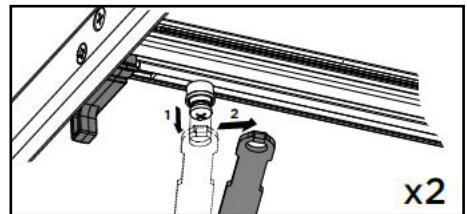
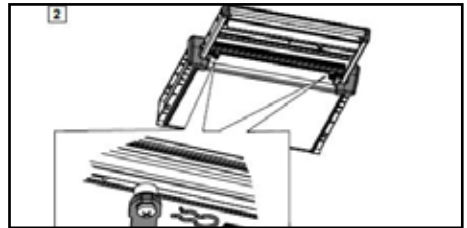

# WARRANTY

---

Motorhome Warranty Cover.....	165
The Three Warranties.....	165
Customer Support.....	165
Terms and Conditions.....	165
Cover.....	165
Term.....	166
Repairs.....	166
Warranty Registration.....	166
Adamo Rear Vision Camera Monitor.....	167

# WARRANTY

## **MOTORHOME WARRANTY COVER**

Total satisfaction is the top priority at Bailey and the quality ethos extends to the after-sales service and manufacturer's warranty that comes with every new Bailey motorhome. In this way we not only ensure long-term peace of mind but also enhance the resale value of your investment.

Your Bailey motorhome has three warranties:

### **3 YEAR BASE VEHICLE WARRANTY**

The Bailey motorhome is a coach-built model which utilises a Peugeot or Ford base vehicle. Peugeot and Ford provide a manufacturer's warranty for the base vehicle supplied which is subject to the terms and conditions laid down in their handbook. All enquiries relating to this warranty should be directed to your local Service Agent.

### **6 YEAR BODYSHELL INTEGRITY WARRANTY - PROVIDED BY BAILEY**

The Bailey Alu-Tech motorhome is covered by a six (6) year Bodyshell Integrity Warranty. This cover extends to any structural degradation to the bodyshell that arises as a result of water ingress through any permanently sealed seams or joints (with the exception of exclusions stated in the terms and conditions.)

### **WARRANTY EXTENSION**

An additional four (4) year extension to the standard Bodyshell Integrity

Warranty cover (making 10 years' cover in total) is available as a cost option through your supplying Retailer.

### **3 YEAR MANUFACTURER'S WARRANTY - PROVIDED BY BAILEY**

For a period of three (3) years from the initial date of purchase, Bailey offers a comprehensive warranty on all parts and components used in the construction of the Bailey motorhome chassis and habitation area, as well as full coverage for any manufacturing faults forming part of the original specification of the Bailey motorhome with the following specified exceptions:

The following items are covered for one (1) year from the date of first registration

- Leisure batteries
- Microwave ovens

The following items are not covered for private vehicles:

- Replacement bulbs, light emitting diodes, fluorescent tubes and fuses
- Cost of general maintenance

In addition the following items are also not covered for rental vehicles:

- Cosmetic damage to interior and exterior fittings and surfaces

### **WARRANTY EXTENSION**

An additional three (3) year extension to the standard Manufacturer's Warranty cover for mechanical and electrical components of a leisure vehicle both external and internal (making 6 years cover in total) is available as a cost option through your supplying Retailer

### **CUSTOMER SUPPORT**

Approved Bailey Retailers enjoy industry-leading after sales support service from the manufacturer and they will be able to offer all the help you need to rectify any issues that may occur. They should be your first point of contact on any subject relating to your vehicle. It should be noted that Bailey Approved Retailers sell our products of their own choice and not as agents of Bailey. Accordingly, they have no authority to bind Bailey or make representation or undertaking whatsoever on behalf of Bailey.

### **TERMS AND CONDITIONS**

The Peugeot and Ford base vehicles are covered by the base vehicle manufacturer's warranty and any issues with it should be referred to one of the base vehicle manufacturer's agents.

### **COVER**

1. During the term of the Warranty Cover, subject to these terms and conditions, Bailey will, through an Authorised Service Centre, at its option repair or replace all parts and components of the caravan that are included in the Warranty Cover and which suffer a defect in manufacture or workmanship. An Authorised Service Centre means either Bailey itself, a Bailey Approved Retailer or a Bailey Approved Service Centre. Any part which is replaced becomes the property of

Bailey. Any replacement parts are covered for the unexpired term of the Warranty Cover.

## TERM

1. The initial duration of the Bodyshell Integrity Warranty is six (6) years and the duration of the Manufacturer's Warranty is three (3) years in both cases starting from the original purchase date of the vehicle. It is a condition of the warranty that an annual service is performed on the vehicle in accordance with the service plan. Failure to comply with this term will invalidate the warranty.
2. The unexpired term of the Warranty Cover on your vehicle may only be assigned, transferred or novated to subsequent owners with Bailey's consent (not to be unreasonably withheld) and on payment to Bailey of a transfer fee of £35. Transfer can only be made within the first three months (3) of the date subsequent ownership was taken and full documentary evidence that the vehicle has been serviced annually along with evidence of the date of subsequent purchase (in the form of a VAT sales receipt, invoice or bank/credit card statement) must be provided at the time of assignment in accordance with the terms and conditions detailed above

## REPAIRS

4. The motorhome must undergo a full annual habitation service and inspection, including a moisture survey, carried out, subject to paragraph 5 below, by an Authorised Bailey Service Centre or by a service agent that is a member of the National Caravan Council's Approved Workshop Scheme (AWS).
5. The final annual habitation service in any warranty period must be carried out before the end of that warranty period, but all other annual services may be carried out within six (6) weeks either side of each anniversary of the original purchase date. The original VAT invoices must be retained as proof that these annual inspections have been carried out.
6. Where an annual inspection identifies that repairs to the vehicle are necessary, the motorhome must be made available for repair within six (6) weeks of the date of inspection for the purpose of carrying out the repair work. Repairs under warranty must be undertaken by either Bailey itself, a Bailey Approved Retailer or a Bailey Approved Service Centre.

7. No repairs, including the fitting of any replacement unit, may be undertaken or commenced under the terms of the Warranty Cover unless prior written authorisation is obtained from Bailey via a Bailey Approved Retailer or a Bailey Approved Service Centre. No liability will exist with regard to any warranty claims not authorised in this way.
8. Bailey reserve the right to examine the vehicle before any repairs commence or any replacement part is fitted.

## REGISTRATION & USE

9. The Warranty Registration Form must have been sent to Bailey within six (6) weeks of the original purchase date. It is the responsibility of the Bailey Retailer to forward this information to Bailey. This is part of the terms of trading that the Bailey Retailer has with Bailey.
10. The motorhome shall:
  - Only be used for its ordinary and intended purpose and shall not be subjected to any treatment or conditions which could reasonably be foreseen to cause or result in damage to the Bailey motorhome or excessive wear and tear
  - Whilst registered under private ownership not be put out to hire, reward or any other commercial use, nor used in any race, competitions or rallies whether timed, official or otherwise.

## EXCLUSIONS & LIABILITY

11. Bailey's liability under this warranty shall be limited to supplying the reasonable costs of labour and materials required for the repair or replacement of faulty parts or components. Bailey shall be entitled to charge for any repair work which is necessitated by virtue of any loss or damage caused by your negligence or default or incurred as a result of any modifications you have made to the vehicle. This warranty does not cover repair costs other than labour and materials.
12. The Warranty Cover does not include:
  - a Repair or replacement of parts, components, seams or panels which are not part of the original construction of the caravan, or which have been tampered with



or undergone unauthorised modifications, or which have been repaired otherwise than by An Approved Bailey Retailer or a Bailey Approved Service Centre.

- b Parts or components other than those specifically listed in the Bodyshell Integrity Warranty and Manufacturer's Warranty descriptions set out above
  - c General maintenance or components failing due to fair wear and tear or normal deterioration repairs necessitated by lack of routine or regular maintenance. Particular attention is drawn to the Owner's Manual and Service Handbook supplied with the motorhome and any maintenance instructions or notices published from time to time by Bailey relating to the proper care and maintenance of vehicles
  - d Structural degradation or other damage caused by water ingress through non-permanently sealed seams or joints (such as, without limitation, around windows, hatches, doors and rooflights), beyond the initial 24 months of the Manufacturer's Warranty.
13. No liability will be accepted for:
- a Damage caused by neglect or abuse, corrosion, intrusion of foreign or deleterious substances, lack of servicing, over- heating, freezing, or the continued use of the vehicle after a fault has become evident
  - b Any loss or damage caused by parts not covered by this Warranty Cover, including soft furnishings or trim
  - c Any accidental or fire damage or any losses incurred by accident or fire
  - d Transport costs to and from point of repair.

Bailey will only be liable for costs which are incurred as a direct consequence of the event, defect or fault leading to the claim being made under this warranty. No liability will be accepted for any other loss or damage (such as loss of income or revenue, or loss of business or profits), costs, expenses or other claims for compensation howsoever arising which was not reasonably foreseeable by both parties when the caravan was originally purchased. Bailey will not be liable for any loss or damage suffered by third parties, nor for bodily injury not caused by our negligence.

Nothing in this warranty shall limit in any way our liability: for death or personal injury caused by our negligence; for fraud or fraudulent misrepresentation; or for any matter for which it would be illegal for us to exclude, or attempt to exclude, our liability.

The purchaser has statutory rights in addition to this warranty and this warranty does not affect those statutory rights.

This warranty shall be governed by and construed in accordance with the laws of England and the parties irrevocably submit to the non-exclusive jurisdiction of the courts of England.

**WARRANTY REGISTRATION:**

The supplying retailer must explain the warranty terms and conditions to you, and complete the warranty registration process online. Your warranty will start on the day that the vehicle is first registered in the UK or 12 months from the date on which the vehicle was invoiced to the supplying retailer, whichever is the earlier.

The name and address of the warranty provider is: Bailey Caravans Limited, South Liberty Lane, Bristol, BS3 2SS

**This version: May 2020**

**WARRANTY REGISTRATION:**

The supplying retailer must explain the warranty terms and conditions to you and complete the warranty registration process online to ensure that your warranty is active. Your warranty will start on the day that the vehicle is first registered in the UK or 12 months from the date on which the vehicle was invoiced to the supplying retailer, whichever is the earlier.

Please sign below to verify that this has been done.

Customer's Signature: ..... Retailer's Signature:.....

Date: ..... Date: .....



**ADAMO REAR VISION CAMERA MONITOR**

The Adamo Dometic rear vision camera monitor is mounted on the front dash of the Ford cab and has received Type Approval for this mounting position



If you sell your motorhome before the end of the original warranty, the remaining period can be transferred to the new owner using this warranty transfer form together with the following items:

- A photocopy of the service book
- A photocopy of the sales receipt or invoice or similar evidence of sale
- A cheque for £35 made payable to "Bailey Caravans Ltd"
- A covering letter including your full name and address

Send all information to:

Bailey of Bristol,  
South Liberty Lane,  
Bristol,  
BS3 2SS.



In order for the warranty to remain valid the motorhome must have been serviced annually by an authorised Bailey Service Centre prior to the transfer of ownership. Failure to do so will invalidate any further warranty cover. Failure to request this transfer within 3 months of acquisition by the new owner will invalidate the remaining warranty. Terms and Conditions apply.

Model:	
VIN:	
Purchase Date:	
New Owner:	
New Owner's Address:	
New Owner's Telephone Number:	
New Owner's Email Address:	
I have read and understood the terms and conditions of this warranty, including the servicing requirements, as applicable to this vehicle.	
Signed:	
Date:	

If you sell your motorhome before the end of the original warranty, the remaining period can be transferred to the new owner using this warranty transfer form together with the following items:

- A photocopy of the service book
- A photocopy of the sales receipt or invoice or similar evidence of sale
- A cheque for £35 made payable to "Bailey Caravans Ltd"
- A covering letter including your full name and address

Send all information to:

Bailey of Bristol,  
South Liberty Lane,  
Bristol,  
BS3 2SS.



In order for the warranty to remain valid the motorhome must have been serviced annually by an authorised Bailey Service Centre prior to the transfer of ownership. Failure to do so will invalidate any further warranty cover. Failure to request this transfer within 3 months of acquisition by the new owner will invalidate the remaining warranty. Terms and Conditions apply.

Model:	
VIN:	
Purchase Date:	
New Owner:	
New Owner's Address:	
New Owner's Telephone Number:	
New Owner's Email Address:	
I have read and understood the terms and conditions of this warranty, including the servicing requirements, as applicable to this vehicle.	
Signed:	
Date:	

If you sell your motorhome before the end of the original warranty, the remaining period can be transferred to the new owner using this warranty transfer form together with the following items:

- A photocopy of the service book
- A photocopy of the sales receipt or invoice or similar evidence of sale
- A cheque for £35 made payable to "Bailey Caravans Ltd"
- A covering letter including your full name and address

Send all information to:

Bailey of Bristol,  
South Liberty Lane,  
Bristol,  
BS3 2SS.



In order for the warranty to remain valid the motorhome must have been serviced annually by an authorised Bailey Service Centre prior to the transfer of ownership. Failure to do so will invalidate any further warranty cover. Failure to request this transfer within 3 months of acquisition by the new owner will invalidate the remaining warranty. Terms and Conditions apply.

Model:	
VIN:	
Purchase Date:	
New Owner:	
New Owner's Address:	
New Owner's Telephone Number:	
New Owner's Email Address:	
I have read and understood the terms and conditions of this warranty, including the servicing requirements, as applicable to this vehicle.	
Signed:	
Date:	

If you sell your motorhome before the end of the original warranty, the remaining period can be transferred to the new owner using this warranty transfer form together with the following items:

- A photocopy of the service book
- A photocopy of the sales receipt or invoice or similar evidence of sale
- A cheque for £35 made payable to "Bailey Caravans Ltd"
- A covering letter including your full name and address

Send all information to:

Bailey of Bristol,  
South Liberty Lane,  
Bristol,  
BS3 2SS.



In order for the warranty to remain valid the motorhome must have been serviced annually by an authorised Bailey Service Centre prior to the transfer of ownership. Failure to do so will invalidate any further warranty cover. Failure to request this transfer within 3 months of acquisition by the new owner will invalidate the remaining warranty. Terms and Conditions apply.

Model:	
VIN:	
Purchase Date:	
New Owner:	
New Owner's Address:	
New Owner's Telephone Number:	
New Owner's Email Address:	
I have read and understood the terms and conditions of this warranty, including the servicing requirements, as applicable to this vehicle.	
Signed:	
Date:	

Model	
Registration Number:	
Bailey Production Number:	
Registration Date:	
1st Owner's Name:	<b>3RD OWNER'S NAME:</b>
Address:	<b>ADDRESS:</b>
Postcode:	<b>POSTCODE:</b>
Telephone:	<b>TELEPHONE:</b>
2nd Owner's Name:	<b>4TH OWNER'S NAME:</b>
Address:	<b>ADDRESS:</b>
Postcode:	<b>POSTCODE:</b>
Telephone:	Telephone:

## ALLIANCE CIRCUIT DIAGRAM

DRAWING TEMPLATE: A\_CFD48  
 ISSUE DATE: 13/03/2010 ISSUE: 1

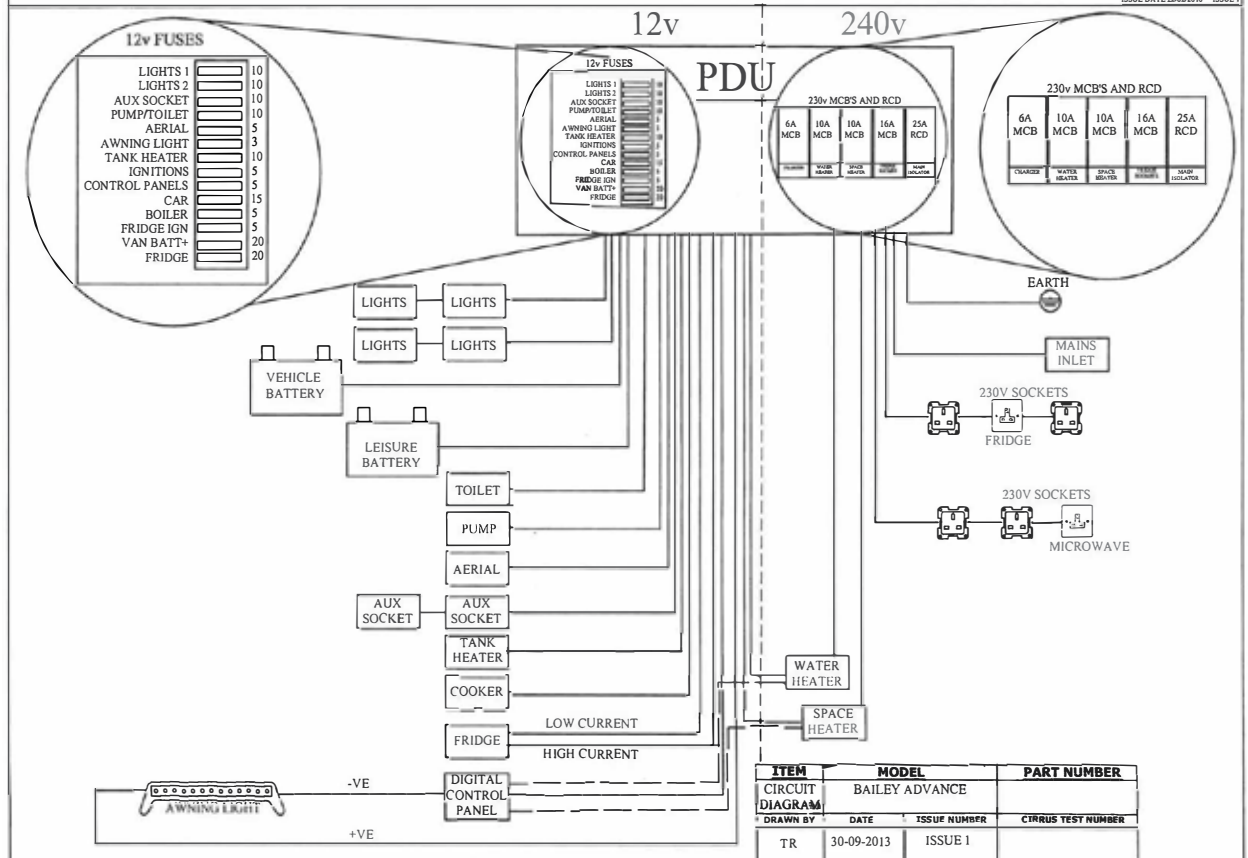

# 240V SYSTEMS

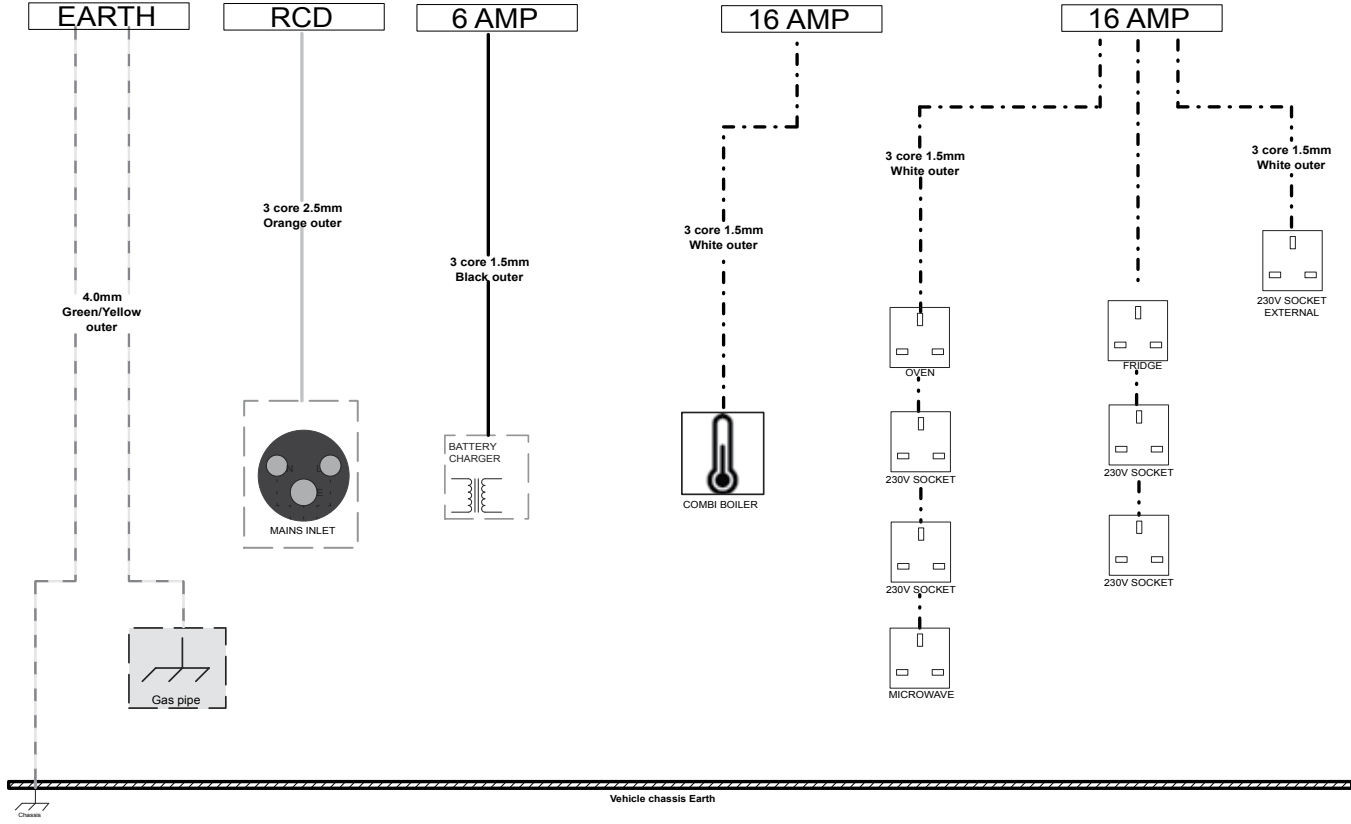



# PDU-RELAYS

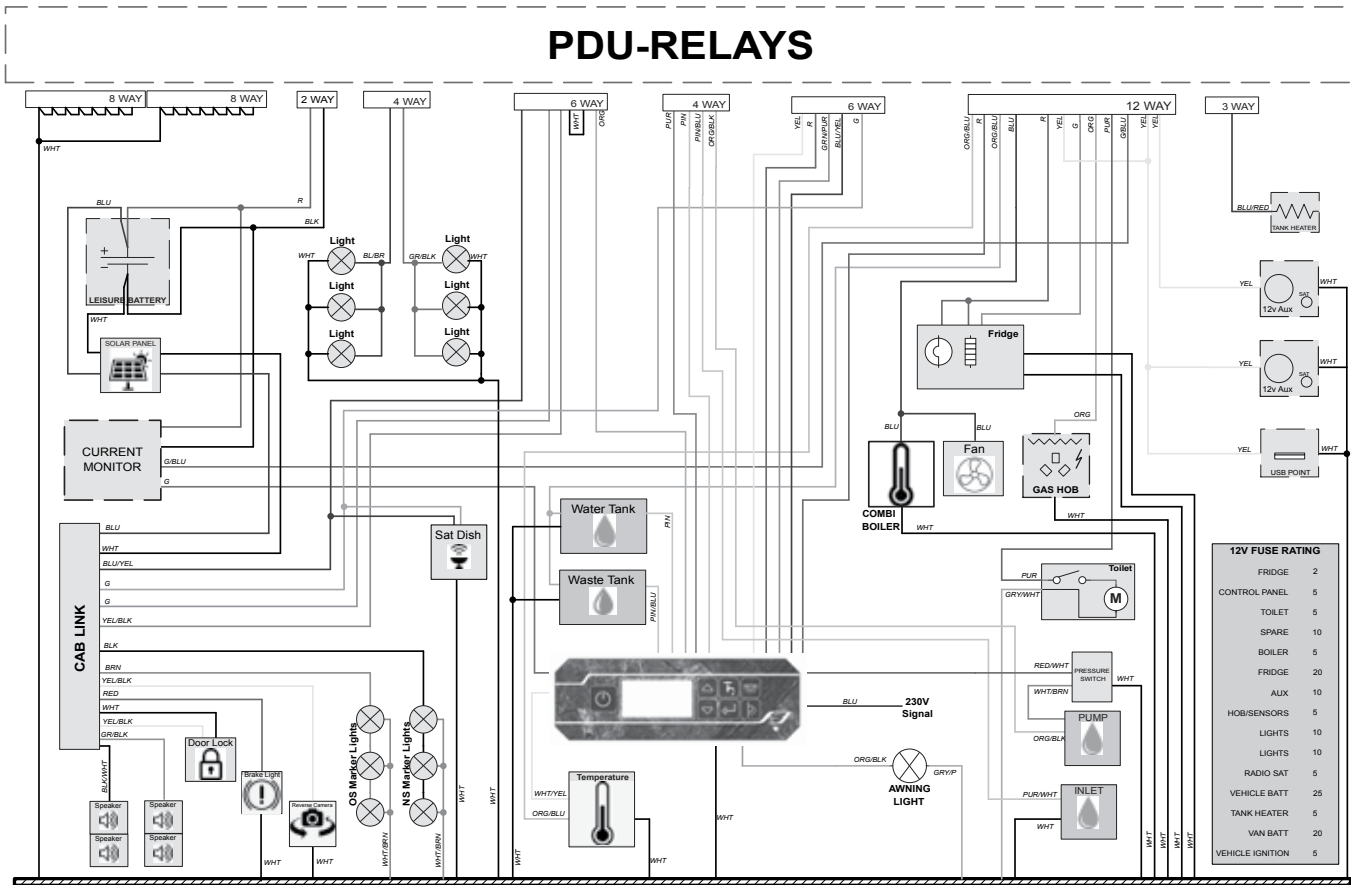

12V FUSE RATING	
FRIDGE	2
CONTROL PANEL	5
TOILET	5
SPARE	10
BOILER	10
FRIDGE	20
AUX	10
HOB/SENSORS	5
LIGHTS	10
LIGHTS	10
RADIO SAT	5
VEHICLE BATT	25
TANK HEATER	5
VAN BATT	20
VEHICLE IGNITION	5

Model	Adamo 69-4	Adamo 75-4i	Adamo 75-4DL
Engine (6.2D)	1995	1995	1995
MTPLM (Kg)	3500	3500	3500
MIRO (Kg) (+/- 5%)	3090	3148	3160
User payload (Kg)	410	352	340
Conventional load (75 kg per person excluding the driver)(Kg)	225	225	225
Designated Passenger Seats(excluding the driver)	3	3	3
Essential Habitation equipment (Kg)	16.1	16.1	16.1
Gross train (Kg)	N/A	N/A	N/A
MBTM(Kg)	N/A	N/A	N/A
Maximun Tow Ball Nose Weight(Kg)	N/A	N/A	N/A
Front axle(Kg)	1850	1850	1850
Rear axle (Kg)	2000	2000	2000

Adamo essential Habitation equipment	
Gas Bottle (Kg)	10
Fresh water (Kg)	0
Fix and Go kit (Kg)	2.1
LV Cable (Kg)	4
Leisure Battery(Kg)	0
	16.1

Model	Adamo 69-4	Adamo 75-4i	Adamo 75-4DL
Base Vehicle Manufacturer	Ford	Ford	Ford
Chassis	Ford	Ford	Ford
Base Vehicle Model	Transit	Transit	Transit
Wheel Base Length	3953mm	3953mm	3953mm
Overall Length	6987mm	7485mm	7485mm
Overall Width (mirrors extended)	2715mm	2715mm	2715mm
Overall Width (mirrors folded)	2379mm	2379mm	2379mm
Overall Height	2849mm	2849mm	2849mm
Front Bed	2220mm (L) x 1295mm (W)	2220mm (L) x 1205mm (W)	(Optional) 2220mm (L) x 1390mm (W)
Drop Down Bed (Where fitted)	1840mm (L) x 1560mm (W)	N/A	(2x) 1840mm (L) x 1350mm (W)
Rear N/S Double	N/A	N/A	N/A
N/S Bunk	N/A	N/A	N/A
O/S Bunk	N/A	N/A	N/A
Rear N/S Bunk	N/A	N/A	N/A
Rear O/S Bunk	N/A	N/A	N/A
Rear Double	N/A	1850mm (L) x 1590mm (W)	(Optional) 1990mm (L) x 1295mm (W)
Fresh Water Tank Capacity	100L	100L	100L
Waste Water Tank Capacity	100L	100L	100L
Gas Locker Capacity	2x 11kg refillable gas bottles	1x 11kg & 1x 6kg refillable gas bottles	2x 11kg refillable gas bottles
Tyre Pressure	Front: 53psi Rear: 64psi	Front: 53psi Rear: 64psi	Front: 53psi Rear: 64psi

<b>Alliance Dimensional Data Table</b>							
MODEL	Alliance 70-6	Alliance 76-2T	Alliance 76-4	Alliance 66-2	Alliance 76-4T	Alliance 76-2	Alliance 59-2
Base Vehicle Manufacturer	Peugeot	Peugeot	Peugeot	Peugeot	Peugeot	Peugeot	Peugeot
Chassis	AL-KO AMC	AL-KO AMC	AL-KO AMC	AL-KO AMC	AL-KO AMC	AL-KO AMC	AL-KO AMC
Base Vehicle Model	335	335	335	335	335	335	335
Wheel Base Length	4700mm	4450mm	4450m	3435mm	4450mm	4450mm	3195mm
Overall Length	6955mm	7572mm	7583mm	6593mm	7583mm	7572mm	5985mm
Overall Width (mirrors extended)	2770mm	2770mm	2770mm	2770mm	2770mm	2770mm	2770mm
Overall Width (mirrors folded)	2489 mm	2489 mm	2489 mm	2489 mm	2489 mm	2489 mm	2489 mm
Overall Height	2755 mm	2755 mm	2755 mm	2755 mm	2755 mm	2755 mm	2755 mm
Front Bed	1820 x 1015mm	2095 x 1300mm	2100 x 1300mm	2090 x 1845mm	2100 x 1300mm	2095 x 1300mm	2086 x 1340mm
Drop Down Bed (Where fitted)	1815 x 1215mm	-	-	-	-	-	-
Rear N/S Double	-	-	-	-	-	-	-
N/S Bunk	-	-	-	-	-	-	-
O/S Bunk	-	-	-	-	-	-	-
Rear Double	1535 x 2095mm	-	1930 x 1350mm	-	-	1930 x 1350mm	-
Fresh Water Tank Capacity	95L	95L	95L	95L	95L	95L	95L
Waste Water Tank Capacity	95L	95L	95L	95L	95L	95L	95L
Gas Locker Capacity	2x6 Kg	2x6 Kg	2x6 Kg	2x6 Kg	2x6 Kg	2x6 Kg	2x6 Kg
Tyre Pressure	Front: 54psi Rear: 80psi	Front: 50psi Rear: 80psi	Front: 50psi Rear: 80psi	Front: 50psi Rear: 80psi	Front: 50psi Rear: 80psi	Front: 50psi Rear: 80psi	Front: 50psi Rear: 80psi

\*All bed sizes are measured at their widest point

### Alliance SE Weight Data Table

MODEL	Alliance SE 70-6	Alliance SE 76-2T	Alliance SE 76-4	Alliance SE 66-2	Alliance SE 76-4T	Alliance SE 76-2	Alliance SE 59-2
Vehicle Designation	335	335	335	335	335	335	335
MTPLM (Kg)	3500	3500	3500	3500	3500	3500	3500
MIRO (Kg) (+/- 5%)	2948	2755	2903	2858	2965	3000	2688
User payload (Kg)	177	670	372	567	310	425	737
Conventional load (75 kg per person excluding the driver)(Kg)	375	75	225	75	225	75	75
Designated Passenger Seats(excluding the driver)	5	1	3	1	3	1	1
Essential Habitation equipment (Kg)	46.5	46.5	46.5	46.5	46.5	46.5	46.5
Gross train (Kg)	5500	5500	5500	5500	5500	5500	5500
MBTM(Kg)	2000	2000	2000	2000	2000	2000	2000
Maximun Tow Ball Nose Weight(Kg)	80	80	80	80	80	80	80
Front axle(Kg)	1850	1850	1850	1850	1850	1850	1850
Rear axle (Kg)	2000	2000	2000	2000	2000	2000	2000

<b>MTPLM</b>	<b>3500</b>
Gas Bottle (Kg)	16
Fresh water (Kg)	0
Alde heating fluid (Kg)	
Toilet Flush tank (Kg)	2
LV Cable (Kg)	4
Leisure Battery(Kg)	24.5
	46.5

### Autograph Weight Data Table

Model	79-4i	74-4	79-2F	74-2	79-4F	79-4T	69-2	81-6
Engine Euro 6D (6.2)	2.2 Hdi	2.2 Hdi	2.2 Hdi	2.2 Hdi	2.2 Hdi	2.2 Hdi	2.2 Hdi	2.2 Hdi
Vehicle Designation	335	335	335	335	335	335	335	440
MTPLM (Kg)	3850	3500	3850	3500	3850	3850	3500	4250
MIRO (Kg) (+/- 5%)	3233	3055	3070	3014	3160	3276	2993	3400
User payload (Kg)	392	220	705	411	474	349	432	475
Conventional load (75 kg per person excluding the driver)(Kg)	225	225	75	75	225	225	75	375
Designated Passenger Seats (excluding the driver)	3	3	1	1	3	3	1	5
Essential Habitation equipment (Kg)	61.5	56.5	61.5	56.5	61.5	61.5	56.5	61.5
Gross train (Kg)	5500	5500	5500	5500	5500	5500	5500	6000
MBTM(Kg)	2000	2000	2000	2000	2000	2000	2000	2000
Maximun Tow Ball Nose Weight(Kg)	80	80	80	80	80	80	80	80
Front axle(Kg)	1850	1850	1850	1850	1850	1850	1850	2100
Rear axle (Kg)	2000	2000	2000	2000	2000	2000	2000	2400

MTPLM	3500	3850	4250
Gas Bottle (Kg)	16	16	16
Fresh water (Kg)	0	0	0
Alde heating fluid (Kg)	10	15	15
Toilet Flush tank (Kg)	2	2	2
LV Cable (Kg)	4	4	4
Leisure Battery(Kg)	24.5	24.5	24.5
	56.5	61.5	61.5



Scheduled Service Type	Service Agent	Service Agent Stamp	Technician's Name	Date
12th Year Annual Service				
13th Year Annual Service				
14th Year Annual Service				
15th Year Annual Service				
16th Year Annual Service				
17th Year Annual Service				



Scheduled Service Type	Service Agent	Service Agent Stamp	Technician's Name	Date
6th Year Annual Service				
7th Year Annual Service				
8th Year Annual Service				
9th Year Annual Service				
10th Year Annual Service				
11th Year Annual Service				

Scheduled Service Type	Service Agent	Service Agent Stamp	Technician's Name	Date
Retailer handover inspection				
1st Year Annual Service				
2nd Year Annual Service				
3rd Year Annual Service				
4th Year Annual Service				
5th Year Annual Service				

## MOTORHOME OVERVIEW

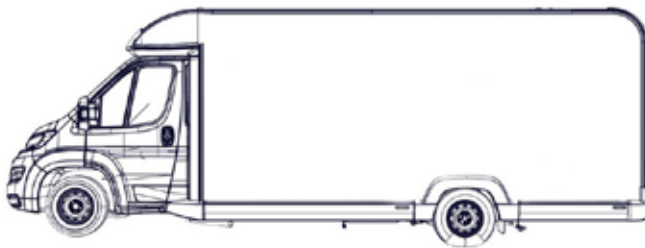
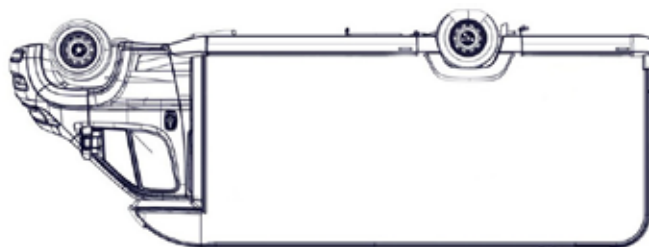
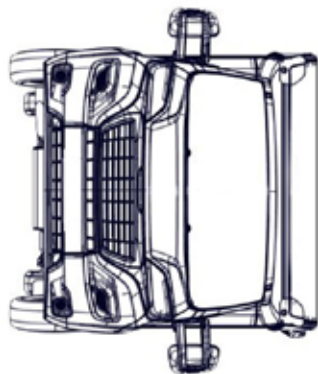

# SERVICE MANUAL

Welcome to your new Bailey Motorhome.

This Service Manual is a record of your motorhome's service history. It includes technical information for your reference. It should be read in conjunction with the Motorhome Owner's Manual.

Your motorhome is designed to give you many years of use. However, regular maintenance is necessary to ensure trouble-free usage. Your Bailey retailer is equipped to offer service and repair work facilities as well as supplying any spare parts that you may require. All enquiries regarding your motorhome should therefore be addressed in the first instance to the retailer from whom you purchased the vehicle.

Manufactured by  
Bailey Caravans Limited, South Liberty Lane,  
Bristol, BS3 2SS

© Bailey of Bristol 2016. All rights reserved.  
No part of this document may be reproduced  
or transmitted in any form or by any means,  
electronic or mechanical, for any purpose,  
without the express permission of Bailey of  
Bristol Ltd.

## MOTORHOME SERVICE SCHEDULE

In order to validate the factory backed warranty package, your motorhome must be serviced by an approved Bailey Service Centre every 12 months (or 6 weeks either side of the anniversary of purchase) in accordance with the NCC recommended service schedule.

A full listing of the current Approved Bailey Centres can be found on the Retailer Network pages of our website [www.baileyofbristol.co.uk](http://www.baileyofbristol.co.uk)



Under no circumstance should the bodyshell fixings be tampered with or adjusted by the motorhome owner. Any tampering or adjustment will invalidate the warranty.

## STANDARD MOISTURE SURVEY FOR ALU-TECH CONSTRUCTION MOTORHOMES

A moisture survey must be carried out using a calibrated moisture meter every 12 months by an Approved Bailey Service Centre.

Readings should be obtained from the floor section of the motorhome in positions where the holes created by the meter's probes are not visible e.g. behind seals, in bed boxes or in cupboard bases. It is important to make sure that the probes are free of moisture and the surface of the floor is free from condensation.

Readings below 20% are considered acceptable. Readings greater than 20% will identify areas that need further investigation and possible remedial work.

All other parts of the body of an Alu-Tech motorhome should be checked visually for moisture ingress.

## THERMAL INSULATION GRADE

All Bailey Alu-Tech Motorhomes are manufactured and approved by the NCC to EN1646-1 thermal insulation and heating classification Grade 3. This has been approved using the motorhome space heater or Alde wet system using both the electric and gas combined as the heating method.

Grade 3 is classified as being able to achieve an average temperature difference of 35 °C between the inside of the motorhome and the outside temperature when the outside temperature is -15°C.

## REPAIRS

Repairs to the AL-KO AMC components including the axle assembly may only be carried out by specialist workshops.

# Alde®

www.alde.co.uk



THE **KING**  
OF COMFORT

We didn't  
invent heating  
We Perfected it.



Central Heating **just like home**

Ask your dealer about **Alde Heating Systems** today

**MORE THAN  
UP TO IT**



## Go anywhere, do everything

We love using our caravans and motorhomes as much as you do.

In recent years we have gone on a number of our own adventures across the world, journeying as far afield as Finland, Turkey and even Australia!

We'd really like to hear about where you go and what you do on your travels with your new Bailey, so why not share your stories with us on our social media pages?

Join our community:



**GO BAILEY!**

[www.baileyofbristol.co.uk](http://www.baileyofbristol.co.uk)



Motorhome Owners Manual October 2020

*Autograph*

**ALLIANCE**  
*Silver Edition*

**ADAMO**